

ДЕРЖАВНА СЛУЖБА УКРАЇНИ З НАДЗВИЧАЙНИХ СИТУАЦІЙ
НАЦІОНАЛЬНИЙ УНІВЕРСИТЕТ ЦИВІЛЬНОГО ЗАХИСТУ УКРАЇНИ

ISSN 2522-1892 (print)
ISSN 2522-1930 (online)

Науково-технічний журнал
«ТЕХНОГЕННО-ЕКОЛОГІЧНА БЕЗПЕКА»

Scientific and technical journal
«TECHNOGENIC AND ECOLOGICAL SAFETY»

Випуск 7(1/2020)

Свідоцтво про державну реєстрацію
КВ №22536-12436 Р від 01.03.2017

Затверджено до друку вченою радою
НУЦЗ України (протокол № 8 від 30.04.2020)

Харків
2020

РЕДАКЦІЙНА КОЛЕГІЯ

В. П. Садковий д. держ. упр., проф. – голова редакційної колегії (Україна)
В. А. Андронов д. т. н., проф. – головний редактор (Україна)
В. Ю. Колосков к. т. н., доц. – відповідальний секретар (Україна)

О. І. Запорожець д. т. н., проф. (Україна)
Т. В. Козуля д. т. н., проф. (Україна)
М. В. Новожилова д. ф.-м. н., проф. (Україна)
С. Ю. Саєнко д. т. н., с. н. с. (Україна)
В. Л. Филипчук д. т. н., проф. (Україна)
С. Д. Цибуля д. т. н., проф. (Україна)

І. А. Чуб д. т. н., проф. (Україна)
Р. В. Пономаренко к. т. н., с. н. с. (Україна)
О. В. Рибалова к. т. н., доц. (Україна)
А. А. Хаміді д. філос. (Малайзія)
Р. Рафієс д. філос. (Іран)

EDITORIAL BOARD

Volodymyr Sadkovyj DSc (Public Administration), Full Professor – Chairman of the editorial board (Ukraine)
Volodymyr Andronov DSc (Technical), Full Professor – Editor-in-Chief (Ukraine)
Volodymyr Koloskov PhD, Associate Professor – Secretary-in-Charge (Ukraine)

Olexandr Zaporozhets DSc (Technical), Full Professor (Ukraine)
Tatiana Kozulia DSc (Technical), Full Professor (Ukraine)
Maryna Novozhylova DSc (Physics and Mathematics), Full Professor (Ukraine)
Sergey Sayenko DSc (Technical), Senior Researcher (Ukraine)
Viktor Fylypchuk DSc (Technical), Full Professor (Ukraine)
Sergij Tsybulia DSc (Technical), Full Professor (Ukraine)
Igor Chub DSc (Technical), Full Professor (Ukraine)
Roman Ponomarenko PhD, Senior Researcher (Ukraine)
Olha Rybalova PhD, Associate Professor (Ukraine)
Hamidi Abdul Aziz Ph.D. (Malaysia)
Rafiee Reza, Ph.D (Iran)

РЕДАКЦИОННАЯ КОЛЛЕГИЯ

В. П. Садковой д. гос. упр., проф. – глава редакционной коллегии (Украина)
В. А. Андронов д. т. н., проф. – главный редактор (Украина)
В. Ю. Колосков к. т. н., доц. – ответственный секретарь (Украина)

А. И. Запорожец д. т. н., проф. (Украина)
Т. В. Козуля д. т. н., проф. (Украина)
М. В. Новожилова д. ф.-м. н., проф. (Украина)
С. Ю. Саєнко д. т. н., с. н. с. (Украина)
В. Л. Филипчук д. т. н., проф. (Украина)
С. Д. Цибуля д. т. н., доц. (Украина)

И. А. Чуб д. т. н., проф. (Украина)
Р. В. Пономаренко к. т. н., с. н. с. (Украина)
О. В. Рибалова к. т. н., доц. (Украина)
А. А. Хамиди д. филос. (Малайзия)
Р. Рафиее д. филос. (Иран)

Науково-технічний журнал «Техногенно-екологічна безпека» включено до:

- переліку наукових фахових видань України, в яких можуть публікуватися результати дисертаційних робіт на здобуття наукових ступенів доктора і кандидата наук (наказ № 1413 від 24 жовтня 2017 р.);
- Категорії «Б» переліку наукових фахових видань України, в яких можуть публікуватися результати дисертаційних робіт на здобуття наукових ступенів доктора і кандидата наук, галузь науки – технічні, спеціальність – 183 «Технології захисту навколишнього середовища» (наказ № 1412 від 18 грудня 2018 р.);
- платформи «Наукова періодика України» у Національній бібліотеці ім. В. І. Вернадського;
- міжнародної бази даних Ulrichsweb (Ulrich's Periodicals Directory);
- міжнародної бази даних Index Copernicus International;
- міжнародної індексаційної бази ResearchBib;
- європейської репозитарної бази даних OpenAIRE;
- довідника міжнародних наукових журналів у співпраці з провідними університетами CiteFactor.

Техногенно-екологічна безпека: наук.-техн. журн. – X : НУЦЗ України, 2020. Вип. 7(1/2020). 66 с.

Scientific and technical journal «Technogenic and Ecological Safety»

RESEARCH ARTICLE
OPEN ACCESS

ASSESSMENT OF ECOLOGICAL AND CHEMICAL EFFICIENCY OF EXPLOITATION PROCESS OF RECIPROCATING ICE OF VEHICLE WITH CONSIDERATION OF EMISSION OF SULPHUR OXIDES, BENZO(a)PYRENE AND POLYCYCLIC AROMATIC HYDROCARBONS

O. Kondratenko¹¹National University of Civil Defence of Ukraine, Kharkiv, Ukraine

UDC 504.064.4 : 621.431 : 389.14 : 528.088

DOI: 10.5281/zenodo.3780076

Received: 27 February 2020

Accepted: 22 April 2020

Cite as: Kondratenko O. (2020). Assessment of ecological and chemical efficiency of exploitation process of reciprocating ICE of vehicle with consideration of emission of sulphur oxides, benzo(a)pyrene and polycyclic aromatic hydrocarbons. *Technogenic and ecological safety*, 7(1/2020), 38–50. doi: 10.5281/zenodo.3780076

Abstract

In this study the previously proposed by the author techniques of determination of magnitudes of mass hourly emissions of sulphur oxides, benzo(a)pyrene and polycyclic aromatic hydrocarbons in diesel engine exhaust gases flow have been improved. Distributions of magnitudes of such emissions on operational regimes field of 2Ch10.5/12 autotractor diesel engine and on regimes of standardised steady testing cycle ESC were obtained. The mathematical apparatus and technique of application of index of ecology-chemical evaluation of ICE of Prof. P. M. Kanilo have been improved as the alternative for complex fuel-ecological criterion of Prof. I. V. Parsadanov. Distributions of magnitudes of such indicator of ecological safety level of power plants with reciprocating ICE exploitation process on operational regimes field of 2Ch10.5/12 autotractor diesel engine and on regimes of standardised steady testing cycle ESC were obtained together with its middle exploitational magnitude. It is established that, in case of considering of values of mass hourly emission of sulphur oxides, benzo(a)pyrene and other PAH in the criteria-based assessment of efficiency of exploitation process of vehicles with diesel ICE with using of mathematical apparatus of the integral indicator of ecological-chemical evaluation, the minimum efficiency is characterized by the maximum torque regime ($F = 1.029$), and by the maximum efficiency – regime with low effective power ($F = 0.091$), the regime of nominal effective power – by average efficiency ($F = 0.500$), and the minimal idle regime ($F = 0.178$) – by high efficiency. Middle exploitational magnitude of index F for the ESC standardised steady testing cycle and 2Ch10.5/12 diesel engine is 0.373.

Key words: system object, probabilistic entropy estimation, entropic state function, structural matrix, cognitive approach, complex estimation, equilibrium, research model.

Relevance of the study.

It is well known that the actual ecological status of all environmental components – the atmosphere, hydro and lithosphere – both on a planetary scale and on a scale of a single urbanized and anthropogenically loaded territory, is of considerable concern and has a clear tendency to worsen. This situation is caused by the gradual evolutionary development of civilization, which accelerated over the XX century and was accompanied by a steady increase in the level of scientific and technological progress and the rapid development of industrial production [1–3].

This tendency is mainly due to the expansion of the range of countries and regions of the world, where new types of production are being developed, innovative technologies (including the so-called «nano») are being introduced, new raw material deposits are being developed, environmental standards are being developed and put into operation. This naturally leads to a corresponding increase in the volume of production, and therefore the scale of pollution of environment with harmful substances and waste, as well as the progressive depletion of non-renewable natural resources. The intense component of such an impact is largely determined by the overall increase in the standard of living of the population and the inextricably linked increase in the demand for industrial products, including consumer goods, food, infotainment and so on [4, 5].

For implementation of complex assessment of magnitudes of indicators of ecological safety (ES) level of the exploitation process of power plants (PP) with reciprocating internal combustion engines (RICE) [6], namely vehicles, which are powerful sources of negative influence on environment [7], it is rational to use the mathematical apparatus of complex fuel and ecological criterion of Prof. I. V. Parsadanov K_{fe} (NTU «KhPI») [8] that was described in the monograph [9] and improved in the monograph [10] and developed on the basis of technique [11]. There is the main alternative to criterion K_{fe} – mathematical apparatus of integral index of ecology-chemical evaluation of RICE of Prof. P.M. Kanilo (KhNADU) [12]. This criterion was applied in several studies [13–24].

Emission of legislative normalized pollutants in RICE exhaust gas (EG) flow is ES factor that must be reduced and for that special devices are applied for purification of EG flow [6, 9, 10, 12, 25, 26] and other organization and technical measures. It is also well known that processes of thermal utilization of solid domestic wastes are also powerful sources of emissions of pollutants into atmospheric air [27, 28] as well as processes of combustion of pyrotechnics [29] and forest fires [30] that are detected by means of special measuring instruments [31, 32].

It is known that RICE operational process produces significant mass hourly emissions of sulphur dioxide SO_2 and polycyclic aromatic hydrocarbons (PAH)

including benzo(a)pyrene (B(a)P) as toxic and carcinogenic pollutants [35 – 37]. Taking into account the fact that significant part of EG flow consists of products of completed combustion of motor fuel, namely CO₂ and H₂O, and also that the separate RICE is not powerful source of SO₂, PAH and B(a)P emission but their role and part in world energy balance (at to 70 % [9]) it is possible to conclude that evaluation of such emissions in complex calculated assessment of magnitudes of ES level indicators of PP with RICE exploitation process is scientific and technical problem, the relevance of which has no doubt.

It should be noted that obtained results can be the basis for the implementation of state regulation in the field of ES ensuring, as, for example, in the field of advertising [32] and other economic aspects of complex criteria-based assessment [33].

Purpose of the study. Obtaining of magnitudes of integral index of ecology-chemical evaluation characterizing the ES level of diesel engine exploitation process with taking into account the emissions of sulphur oxides, benzo(a)pyrene and polycyclic aromatic hydrocarbons as the toxic and carcinogenic pollutants.

Problem of the study. Obtaining of distribution of magnitudes of integral index of ecology-chemical evaluation for autotractor diesel engine 2Ch10.5/12 [39] on the standardised steady testing cycle ESC (UENCE Regulations No. 49 [38]) taking into account the emissions of sulphur oxides, benzo(a)pyrene and polycyclic aromatic hydrocarbons as the toxic and carcinogenic pollutants.

Object of the study. Ecological safety of diesel engine exploitation process, the exploitation model of which corresponds to testing cycle ESC.

Subject of the study. Influence of emissions of sulphur oxides, benzo(a)pyrene and polycyclic aromatic hydrocarbons as the toxic and carcinogenic pollutants on qualitative and quantitative aspects of object of the study.

Methods of the study. Analysis of specialized scientific and technical, reference and normative literature, analysis of results of motor bench tests, basics of scientific discipline «Theory of RICE», «Theory of ESMS», «Environment protection technologies», improved mathematical apparatus of complex fuel and ecological criterion, improved mathematical apparatus of integral index of ecology-chemical evaluation, method of least squares.

Tasks of the study.

1. Analysis of features of complex fuel and ecological criterion, integral index of ecology-chemical evaluation and standardised steady testing cycle ESC.

2. Obtaining of initial data set for implementing of calculated assessment for standardised steady testing cycle ESC and diesel engine 2Ch10.5/12 as a part of emergency and rescue vehicle.

3. Improving of application techniques for assessing of magnitudes of mass hourly emissions of sulphur oxides, benzo(a)pyrene and polycyclic aromatic hydrocarbons with RICE EG flow and potenderability of such ES factor as the toxic pollutant and as the carcinogenic substances.

4. Calculated assessment of magnitudes of integral index of ecology-chemical evaluation for standardised steady testing cycle ESC and analysis of its results.

Scientific novelty of obtained results. Received further development of the approach of Prof. P.M. Kanilo for criteria-based assessment of ecology-chemical efficiency of autotractor diesel engines exploitation process as a part of emergency and rescue vehicle taking into account of mass hourly emissions of sulphur oxides, benzo(a)pyrene and polycyclic aromatic hydrocarbons with RICE EG flow as the toxic pollutants and as the carcinogenic substances and also techniques for determination of such emissions and ponderability of such pollutants in direction of application of this mathematical apparatus for standardised steady testing cycles.

Practical value of obtained results. Obtained results are suitable for providing the qualitative and quantitative assessment of ES level of different types of diesel engine exploitation process taking into account the emissions of sulphur oxides, benzo(a)pyrene and polycyclic aromatic hydrocarbons with RICE EG flow as the toxic pollutant and as the carcinogenic substances.

1. Analysis of mathematical apparatus of integral index of ecology-chemical evaluation of RICE of Prof. P.M. Kanilo

In studies of Prof. P.M. Kanilo (KhNADU) [12–15] he has proposed the integral index of ecology-chemical evaluation of RICE and degree of efficiency of its improving that in accordance with developed by author of this study classification of criteria-based mathematical apparatuses that are suitable for implementation of complex calculated assessment of operation efficiency of ES management system (ESMS) of the process of accident-free exploitation process that was developed by author in study [8] related to types of causal or internal.

Magnitudes of the index *F* for one complete cycle on testing of RICE of the test bench with running drums are determined by formula (1) [12, 16]:

$$F_j = 10^{-3} \times \left\{ \left(\frac{M_{CO}}{[CO]} + \frac{M_{CH}}{[CH]} + a \cdot \frac{M_{NO_2}}{[NO_2]} + b \cdot \frac{M_{Soot}}{[Soot]} \right) + \left(c \cdot \frac{M_{SO_2}}{[SO_2]} + d \cdot \frac{\Sigma CA_{(EG)}}{[B(a)P]} \right) \right\}_{tc} \quad (1)$$

where *M_k* – mass of emission of *k*-th pollutant during one complete cycle on testing of RICE (see index «*ts*»), kg/cycle; [*k*] = [MPC_{*k*}]_{dn} – maximum permissible concentration of *k*-th pollutant, kg/m³; *a* = 3,0; *b* = 3,0; *c* = 2,0; *d* = 4,0 – coefficients that take into account the further intensification of the total effect of toxic and carcinogenic substances in the composition of EG of RICE on humans.

In this study modified variant of formula (1) was used, i.e. index *F*. Instead of the values of mass of emission of *k*-th pollutant during one complete cycle on testing of RICE *M_k* (in kg/cycle) author proposes to use

in it the values of mass hourly emission of of k -th pollutant $G(k)$ on individual regime of exploitation model (in kg/h). Such approach allows excepting solution of problem of absence of initial data of appropriate type (i.e. values of M_k) and also obtaining the individual regime values of index F that is values for each separate representative steady operational regime of RICE exploitation model. Because of this, the index F gets the dimension $[\text{kg/h}] / [\text{kg/m}^3] = [\text{m}^3/\text{h}]$.

The main problem of application of index F and formula (1) is the uncertainty of magnitudes of empirical coefficients a, b, c and d for RICE of different types and models besides those, for which studies described in monograph [12] were carried out. In this study the values of the empirical coefficients recommended in Prof. Kanilo's studies were used.

Index F is the alternative to complex fuel-ecology criterion of Prof. I.V. Parsadanov K_{fe} .

In this case the need for determination of middle exploitation value of index F appears. In this study author proposes to obtain it as the weighted arithmetic mean i.e. by the formula (2).

$$F = \frac{\sum_{i=1}^N (F_i \cdot WF_i)}{\sum_{i=1}^N (WF_i)}; \sum_{i=1}^N (WF_i) = 1,0. \quad (2)$$

2. Obtaining an initial data set for a standardised steady test cycle ESC

Several approaches for performing the criteria-based assessment of the ES level of PP with RICE exploitation process are known and described in the studies [8, 10] and the technique [11].

Standardised steady testing cycle ESC (European Steady Cycle) described in standard [38] is used to build a test program for passenger vehicles and contains 13 steady regimes of RICE operation.

Parameters of ESC cycle regimes for 2Ch10.5/12 diesel engine according to [38] are determined by the formula (3) (see Fig. 1):

$$n_k = n_{lo} + G \cdot (n_{hi} - n_{lo}), \text{ rpm}; \quad (3)$$

where n_{lo} i n_{hi} – low and high crankshaft speed i.e. minimal crankshaft speed at what RICE effective power reaches 50 % and 75 % of its declared nominal magnitude, rpm; at $k = A \rightarrow G = 0,25$; at $k = B \rightarrow G = 0,50$; at $k = C \rightarrow G = 0,75$.

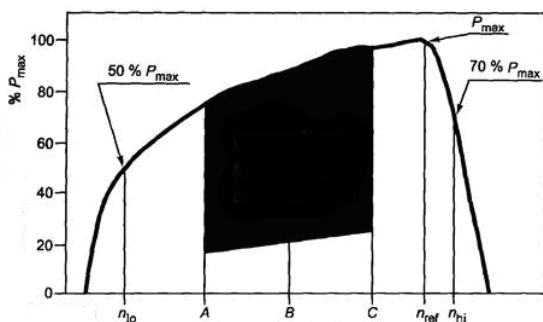

Figure 1 – Distribution of parameters of standardised steady testing cycle ESC on operational regimes field of diesel engine [38]

For 2Ch10.5/12 diesel engine the maximum effective power is 21 kW reached at $M = 110 \text{ N}\cdot\text{m}$ ra $n_{cs} = 1800 \text{ rpm}$ [39]. Using the results of analysis of the diagram of operation of this diesel engine we obtain following initial data: $n_{lo} = 1000 \text{ rpm}$, $n_{hi} = 2000 \text{ rpm}$, than: $n_A = 1250 \text{ rpm}$, $n_B = 1500 \text{ rpm}$, $n_C = 1750 \text{ rpm}$. In this case: $M_{Amax} = 108 \text{ N}\cdot\text{m}$, $M_{Bmax} = 102 \text{ N}\cdot\text{m}$, $M_{Cmax} = 93 \text{ N}\cdot\text{m}$, than: $N_{eAmax} = 14,136 \text{ kW}$, $N_{eBmax} = 16,021 \text{ kW}$, $N_{eCmax} = 17,042 \text{ kW}$.

Also from analysis of results of motor bench tests of D21A1 (2Ch10.5/12/12 in accordance with ISO 3046-1:2002) diesel engine performed in the Laboratory of Piston Power Plants of Department of Hydrogen Energy of A. Pidgorny Institute for Mechanical Engineering Problems of NAS of Ukraine (Kharkiv) initial data were taken for regimes of ESC testing cycle, which are illustrated at Fig. 2 (technical and economical indicators) and Fig. 3 (ecological indicators).

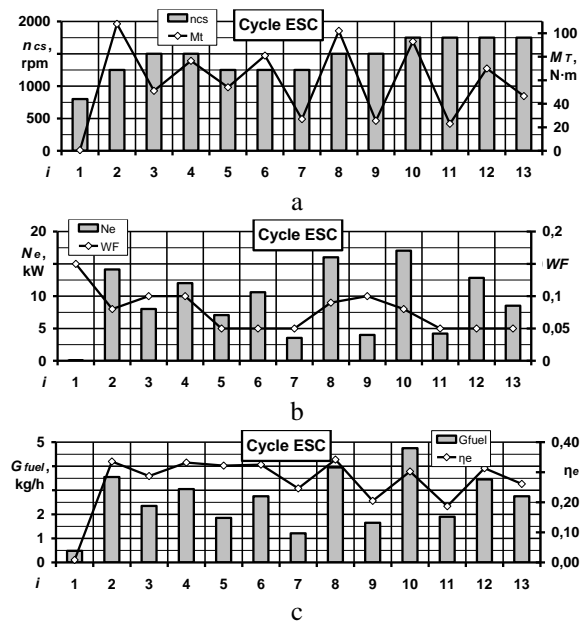

Figure 2 – Distribution of magnitudes of values of technical and economical indicators of operation of 2Ch10.5/12 diesel engine on regimes of ESC testing cycle

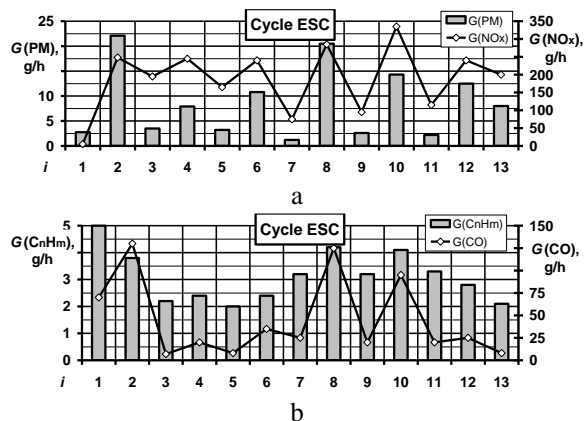

Figure 3 – Distribution of magnitudes of values of economical indicators of operation of 2Ch10.5/12 diesel engine on regimes of ESC testing cycle

Distribution of magnitudes of values of coordinates of operational regimes field – M and n_{cs} – on Fig. 2,a, effective power N_e and weight factor WF – on Fig. 2,b, mass hourly consumption of motor fuel G_{fuel} and effective efficiency coefficient η_e – on Fig. 2,c, mass hourly emission of particulate matter $G(PM)$ and nitrogen oxides $G(NO_x)$ – on Fig. 3,a, mass hourly emission of unburned hydrocarbons $G(C_nH_m)$ and carbon monoxide $G(CO)$ – on Fig. 3,b.

Studies [16–24] performed together by Prof. P.M. Kanilo and Assoc. Prof. M.V. Sarapina are dedicated to such topic to one degree or another.

Technical characteristic of 2Ch10.5/12 diesel engine is contained in source [39].

Diesel engine D21A1 (2Ch10.5/12 in accordance with GOST 10150–2014 «Reciprocating internal combustion engines. General technical requirements») is autotractor non supercharged air-cooled two-cylinder in-line four-stroke two-valve reciprocating ICE with internal mixture formation and ignition of compression, with traditional trunk axial crankshaft mechanism, with cylinder diameter 105 mm, piston stroke 120 mm and connecting rod length 270 mm, working volume 2.0 l, compression degree 16.5, nominal effective power (at 1800 rpm) 21.3 kW, maximum torque 111 N·m (at 1200 rpm), with specific effective mass hourly fuel consumption 235 g/(kW·h), with undivided hemispherical combustion chamber in the piston and direct injection, with one-plunger high pressure fuel pump of distribution type, hydromechanical nozzles and all-regimes mechanical regulator, with mass 280 kg and overall dimensions 693×687×855 mm, with starting by electric starter. It was produced by Vladimir Tractor Plant and used for driving tractors, self-propelled chassis and breeding combines, asphalt and concrete pavers, mobile electric welding, water pumping and air compressor stations [39]. Longitudinal section and cross-section of such diesel engine are illustrated on Fig. 4 [39].

4.2. Technique of calculated evaluation of magnitudes of integral index of ecology-chemical evaluation of RICE with taking into account of emission of sulphur oxides, benzo(a)pyrene and PAH

From specialized literature [6, 9, 10, 12, 25, 26, 35–38] it is well known that in the structure of PM as the legislative normalized pollutant in composition of EG of RICE are contained different types of PAH in number of which is B(a)P what, firstly, is not legislative normalized pollutant in EG composition but at the same time, secondly, is the indicator of presence of PAH in EG and, thirdly, is the strongest and most typical carcinogen in environment, toxicant and mutagen, so because of that assigned to the first class of danger.

B(a)P is chemical compound that has chemical formula $C_{20}H_{12}$ (registration No. CAS 50-32-8, PubChem 2336, EINECS 200-028-5, ChEBI 29865, ChemSpider 2246) and magnitude of molar mass 252.3 g/mole, at the normal conditions (25 °C, 100 kPa) is the solid crystalline substance with pale yellow colour with magnitude of density 1.24 g/dm³, magnitude of melting temperature 179 °C, boiling temperature 495 °C, has poor solubility in water $6.2 \cdot 10^{-5}$ g/100 ml [35–38].

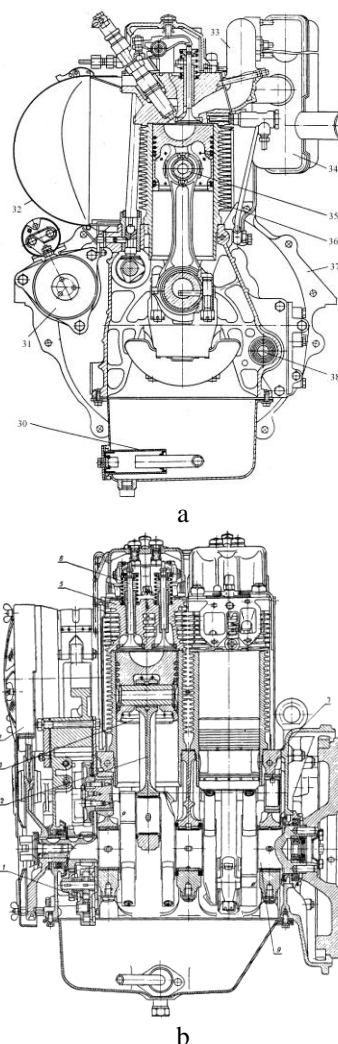

Figure 4 – Longitudinal section and cross-section of 2Ch10.85/12 diesel engine [39]

Structure of B(a)P molecule is illustrated at Fig. 5.

In accordance with hygienic standard 2.1.6.3492-17 «Maximum permissible concentrations (MPC) of pollutants in the air of urban and rural settlements» that approved on 12/22/2017 $MPC_{ad}(B(a)P) = 10^{-6}$ mg/m³. In accordance with hygienic standard 2.1.7.2041-06 in the soil $MPC(B(a)P) = 2 \cdot 10^{-2}$ mg/kg. In accordance with regulations TPTC 021/2011 containment of B(a)P in different foods should not exceed 0.2 – 5.0 µg/kg.

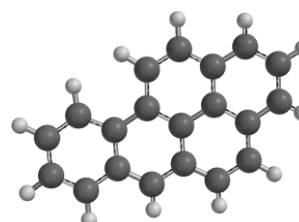

Figure 5 – Structure of B(a)P molecule [35]

For carrying out of complex criteria-based assessment of ES level of exploitation process of PP with RICE, namely vehicles, it is rational to use one of the two following mathematical apparatuses which are most suitable for implementation of such scientific task.

1. Complex fuel and ecological criterion of Prof. I.V. Parsadanov K_{fe} described in monograph [9] and improved in monograph [10].

2. Integral index of ecology-chemical evaluation of RICE of Prof. P.M. Kanilo F described in monograph [12].

For such studies it is necessary to obtain the magnitude of ponderability of values of mass hourly emissions $G(B(a)P)$ and $G(PAH)$ in comparison with ponderability of value of mass hourly emission of reference pollutant $G(CO)$, which is determined by the magnitude of dimensionless indicator of the relative aggressiveness of the k -th pollutant A_k , which is determined by formulas (4) and (5) according to technique [11]:

$$A_k = a_k \cdot \alpha_k \cdot \beta_k \cdot \delta_k, \quad (4)$$

$$a_k = \sqrt{\frac{MPC_{ad}(CO) \cdot MPC_{ot}(CO)}{MPC_{ad}(k) \cdot MPC_{ot}(k)}}, \quad (5)$$

where a_k – index of relative danger of presence of k -th gaseous or aerosol pollutant in atmospheric air that a human breathes; α_k – corrective that takes into account the probability of accumulation of k -th gaseous or aerosol pollutant in environment components, trophic chains and admission to the human body by non-inhalation way; β_k – corrective that takes into account the probability of formation of other (secondary) pollutants, more harmful than the original, by the source of the k -th gaseous or aerosol pollutant emitted into the atmosphere; δ_k – corrective that takes into account the impact of k -th gaseous or aerosol pollutant on other recipients except human; $MPC_{ad}(CO)$ and $MPC_{ot}(CO)$, $MPC_{ad}(k)$ and $MPC_{ot}(k)$ – maximum permissible concentration of reference ($A_{CO} = 1.0$, $MPC_{ad}(CO) = 3.0 \text{ mg/m}^3$, $MPC_{ot}(CO) = 20.0 \text{ mg/m}^3$) and k -th pollutant in air average day-and-night and maximum one-time, mg/m^3 .

In [12] information is contained about components of formulas (4) and (5) for value $A(B(a)P)$ that is given in Table 1 and illustrated at Fig. 6. Thus, value $A(B(a)P)$ is equal to $12.6 \cdot 10^5$, which is 6 orders of magnitude greater than for reference pollutant $A(CO)$, 5 orders of magnitude greater than $A(NO_x)$ and $A(C_nH_m)$, and 4 orders of magnitude greater than $A(PM)$.

At Fig. 6 and in Table 1 you may see that in case of considering of magnitudes of value of $G(B(a)P)$ in criteria-based assessment the magnitude of value $A(PM)$ is about $1.587 \cdot 10^{-2} \%$ from total ponderability of ecological component of criterion K_{fe} , magnitude of value $A(NO_x)$ – $3.262 \cdot 10^{-3} \%$, magnitude of value $A(CO)$ – $7.932 \cdot 10^{-5} \%$ and the rest of such ponderability 99.981 % accounted for magnitude of value $A(B(a)P)$.

In case of considering of magnitudes of value of $G(PAH)$ the ponderability of such pollutant is 0.990 % from total ponderability and for value $A(PM)$ – $1.571 \cdot 10^{-2} \%$, value $A(NO_x)$ – $3.232 \cdot 10^{-3} \%$, value $A(C_nH_m)$ – $2.503 \cdot 10^{-4} \%$, value $A(CO)$ – $7.826 \cdot 10^{-5} \%$, value $A(B(a)P)$ – 98.991 %.

Structure of ponderability of complete set of ES factors considered in ecological component of criterion K_{fe} , discussed in this study, is illustrated at Fig. 7.

Table 1 – Parameters of B(a)P as the pollutant in composition of EG of diesel RICE [12]

Pollutant	Indicator				
	a_k	α_k	β_k	δ_k	A_k
CO	1.0	1.0	1.0	1.0	1.0
C_nH_m	0.63	1.0	5.0	1.0	3.16
NO ₂	27.4	1.0	1.0	1.5	41.1
SO ₂	11.0	1.0	1.0	2.0	22.0
C (Soot)	17.5	2.0	1.0	1.2	41.5
PM	–	–	–	–	200
B(a)P	$6.3 \cdot 10^5$	2.0	1.0	1.0	$12.6 \cdot 10^5$
PAH	$6.3 \cdot 10^5$	2.0	1.0	1.0	$12.6 \cdot 10^3$

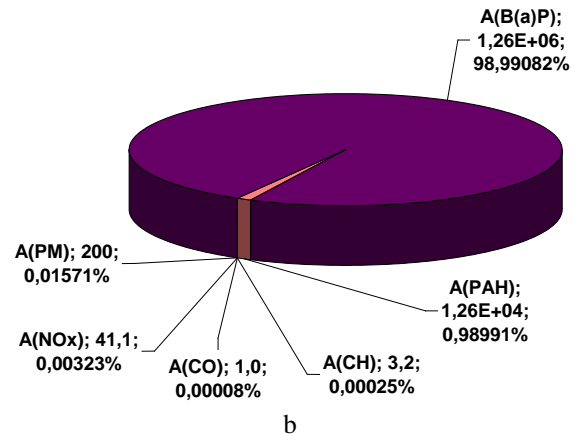
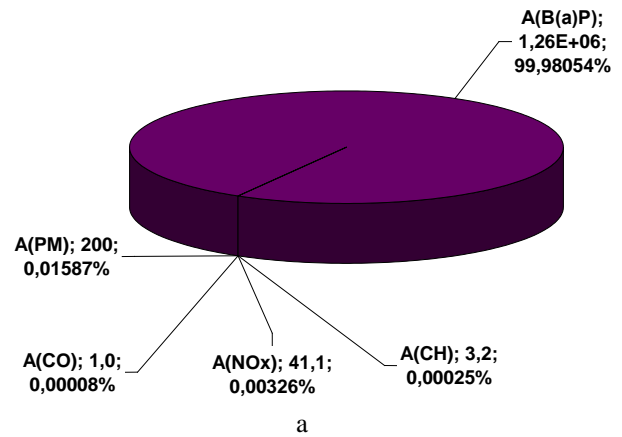

Figure 6 – Structure of ponderability of complete set of ES factors considered in ecological component of criterion K_{fe} with taking into account of emissions of B(a)P (a) and PAH (b)

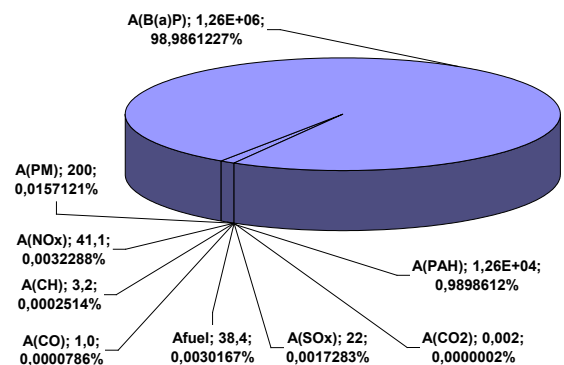

Figure 7 – Structure of ponderability of complete set of ES factors considered in ecological component of criterion K_{fe} with taking into account except of emissions of B(a)P and PAH also emissions of CO₂, SO_x and consumption of motor fuel G_{fuel}

At Fig. 7 it can be seen that in the structure of total ponderability of ecological component of criterion K_{fe} the contribution of separate considered ES factors is following: 98.986 % for $A(B(a)P)$, 0.989 % for $A(PAH)$, $1.571 \cdot 10^{-2}$ % for $A(PM)$, $3.229 \cdot 10^{-3}$ % for $A(NO_x)$, $2.514 \cdot 10^{-4}$ % for $A(C_nH_m)$, $7.862 \cdot 10^{-5}$ % for $A(CO)$, $3.017 \cdot 10^{-3}$ % for A_{fuel} , $1.728 \cdot 10^{-3}$ % for $A(SO_x)$ and $2.122 \cdot 10^{-7}$ % for $A(CO_2)$.

Information about the value of $A(B(a)P)$ can be obtained from sources [12, 16–24] according to the following considerations.

In study [16] it is firmly determined that $B(a)P$ is the indicator of presence of another PAH in composition of RICE EG flow an obtained correlation dependences



between magnitudes of value $G(PAH)$ for all of this ingredients and value $G(B(a)P)$. These correlations is degree dependences in form of formula (6) that was linearized in form of formula (7):

$$m_j = a_1 \cdot m_{B(a)P}^{a_2}, \mu\text{kg/test}; \quad (6)$$

$$m_j = a_3 \cdot m_{B(a)P}, \mu\text{kg/test}. \quad (7)$$

Information about the list of ingredients of PAH of priority group in composition of EG, magnitudes of their carcinogenic activity index CAI , and magnitudes of coefficients in formula (6) is summarised in Table 2.

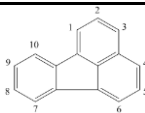
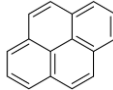
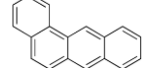
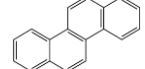
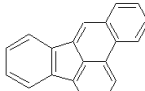
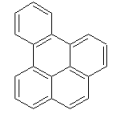
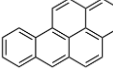
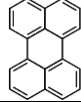
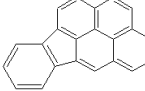
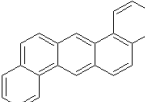
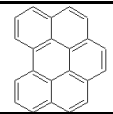
Table 2 – Parameters of PAH of priority group in EG composition for gasoline RICE for testing on cycle EDC [16, 35 – 37]

PAH of priority group	Chemical formula	Class of hazard	Structural formula	Indicator			
				ICA	a_1	a_2	a_3
Fluoranthene	$C_{16}H_{10}$	–		< 0.01	6.2	1.06	–
Pyrene	$C_{16}H_{10}$	I		< 0.01	8.6	1.07	–
Benzo(a)anthracene	$C_{18}H_{12}$	–		0.01	0.55	1.22	–
Chrysen	$C_{18}H_{12}$	–		0.01	2.46	1.24	–
Benzo(b)fluoranthene	$C_{20}H_{12}$	–		0.1	0.94	1.20	–
Benzo(e)pyrene	$C_{20}H_{12}$	–		< 0.01	0.59	1.17	–
Benzo(a)pyrene	$C_{20}H_{12}$	I		1.0	1.0	1.0	–
Perilen	$C_{20}H_{12}$	–		< 0.01	0.59	0.87	–
Indeno[1,2,3-c,d]pyrene	$C_{22}H_{12}$	–		< 0.01	0.37	1.22	–
Dibenzo(a,h)anthracene	$C_{22}H_{14}$	–		< 0.01	0.36	1.23	–
Benzo(g,h,i)perilene	$C_{22}H_{12}$	–		0.01	0.94	1.20	–
Coronene	$C_{24}H_{12}$	–		< 0.01	0.69	1.06	–
$M_{\Sigma PAH}$	–	–	–	–	22.85	1.11	34.6
$M_{\Sigma PAH(K)}$	–	–	–	–	5.8	1.20	11.93
$\Sigma CA(EG)$	–	–	–	–	1.12	1.04	1.28

In Table 2 for the number of carcinogenic related PAH with magnitude of $CAI \geq 0,01$ (marked as PAH(K)), by value $M_{\Sigma PAH}$ is marked the total emission of carcinogenic PAH and by value $\Sigma CA(EG)$ – carcinogenic activity of EG determined by formula (8):

$$\Sigma CA_{(EG)} = \sum_{j=1}^m (CAI_j \cdot m_j). \quad (8)$$

Besides in the study [16] they have also obtained the formula (9) that connects magnitudes of mass emission of B(a)P in EG flow for gasoline engine $m_{B(a)P}$ and mass part of PAH in motor fuel C_{PAH} :

$$m_{B(a)P} = 0,87 \cdot C_{PAH} + 3,3, \mu\text{kg/test}. \quad (9)$$

In study [12] was detected that: relation between magnitudes of mass emission of B(a)P and other PAH in EG composition is correlated as well for gasoline RICE as for diesel RICE; relation between magnitudes of mass emission of B(a)P for gasoline RICE and for diesel RICE k_{RICE} is about 5.0 i.e. in equal volume of EG of diesel RICE emitted almost in 5 times more B(a)P than in EG of gasoline RICE.

That's why in this study it is accepted that magnitude of dimensionless index of relative aggressiveness of PAH except B(a)P A_{PAH} can be determined as product of magnitude of relative aggressiveness index of B(a)P $A_{B(a)P}$ and magnitude of ratio of averaged CAI for PAH (equals 0.01) and B(a)P (equals 1.0) (see formula (10)):

$$A_{PAH} = k_{CAI} \cdot A_{B(a)P} = CAI_{PAH} / CAI_{B(a)P} \cdot A_{B(a)P} = 0.01 / 1.0 \cdot 12.6 \cdot 10^3 = 12.6 \cdot 10^3. \quad (10)$$

The next unsolved task of this study was to obtain individual regime magnitudes of mass hourly emission of B(a)P $G(B(a)P)$ and PAH $G(PAH)$ for 2Ch10.5/12 diesel engine. For solution of this task we need to obtain the middle exploitation magnitude of such emissions and character of distribution of such emissions on operational regimes field of specified RICE.

For determination of middle exploitation magnitude of emissions $G(B(a)P)$ and $G(PAH)$ in this study author used magnitudes of their ratio described by linearized formula (9) with magnitudes of coefficients from Table 2 and also magnitude of ratio between magnitudes of emissions of B(a)P for diesel and gasoline RICE $k_{RICE} = 5.0$ [12].

The basis of proposed approach for obtaining of individual regime magnitudes of value $G(B(a)P)$ is ratio between middle exploitation magnitudes of $G(B(a)P)_{me}$ and another legislative normalized pollutant-prototype namely that distribution on RICE operational regimes field of what will repeat this distribution of magnitude of $G(B(a)P)$.

For determination of form of distribution of magnitudes of value $G(B(a)P)$ on RICE operational regimes field it is proposed to suggest that this distribution in the form completely replicates this distribution for another legislative normalized pollutant-prototype in EG composition.

As such pollutant-prototype it is proposed to choose either unburned hydrocarbons C_nH_m or particulate matter PM. The uncertainty in the selection of the pollutant-prototype is explained with the fact, that the PAH, which include B(a)P, are heavy hydrocarbons, which, at the EG temperature is characterized with a live cross-section of their flow in the plane of the output flange of the RICE exhaust manifold, may be in a gaseous state and at the EG temperature characterized with a live cross-section of their flow in the plane of the cut-off of the RICE exhaust pipe are mostly in the liquid state and make up both separate fractions of PM and adsorbed on PM with soot cores.

Therefore, determination of the individual regime magnitudes of value $G(B(a)P)$ is possible by means of the formulas (11) or (12), and the value of $G(PAH)$ may be determined by the formula (13):

$$G(B(a)P) = G(B(a)P)_{me} / G(C_nH_m)_{me} \cdot k_{RICE} \times G(C_nH_m)(n_{cs}; M); \quad (11)$$

$$G(B(a)P) = G(B(a)P)_{me} / G(PM)_{me} \cdot k_{RICE} \times G(PM)(n_{cs}; M); \quad (12)$$

$$G(PAH) = (a_3 - 1,0) \cdot G(B(a)P). \quad (13)$$

According to materials of studies [12, 16–24] it was determined that for diesel engines magnitude of ratio between values $G(B(a)P)_{me}$ and $G(PM)_{me}$ in average is about $(6.5 \cdot 10^{-3} \text{ g/h} / 50.0 \text{ g/h}) = 1.3 \cdot 10^{-4}$ and ratio between values $G(PM)_{me}$ and $G(C_nH_m)_{me}$ is 2.775 (see monograph [31]), so magnitude of coefficient k_{RICE} in this study was established as 5.0 and coefficient $a_3 - 11.93$. Than formulas (11)–(13) are converted to formulas (14)–(16):

$$G(B(a)P) = 18.0 \cdot 10^{-4} \cdot G(C_nH_m)(n_{cs}; M); \quad (14)$$

$$G(B(a)P) = 6.5 \cdot 10^{-4} \cdot G(PM)(n_{cs}; M); \quad (15)$$

$$G(PAH) = 10.93 \cdot G(B(a)P). \quad (16)$$

Thus, distributions of magnitudes of values $G(B(a)P)$ and $G(PAH)$ on operational regimes field of 2Ch10.5/12 autotractor diesel engine obtains with using of proposed approach (see formulas (14) – (16)) are illustrated at Fig. 8 and 9.

At Fig. 8,a it can be seen that magnitude of value $G(B(a)P)$ repeating the pattern of distribution on operational regimes field of 2Ch10.5/12 diesel engine of magnitude of value $G(C_nH_m)$ reaches maximum equal to 0.01 g/h on regime of nominal effective power and minimum equal to 0.0038 g/h on regime in the middle of external speed characteristics and is. At Fig. 8,b it can be seen that magnitude of value $G(B(a)P)$ repeating the pattern of distribution on operational regimes field of 2Ch10.5/12 diesel engine of magnitude of value $G(PM)$ reaches maximum equal to 0.015 g/h on regime of maximum torque and minimum equal to 0.0015 g/h on regime in the middle of idle characteristics.

At Fig. 9,a it can be seen that magnitude of value $G(PAH)$ repeating the pattern of distribution on operational regimes field of 2Ch10.5/12 diesel engine of magnitude of value $G(C_nH_m)$ reaches maximum equal to 0.1 g/h on regime of nominal effective power and minimum equal to 0.042 g/h on regime in the middle of external speed characteristics.

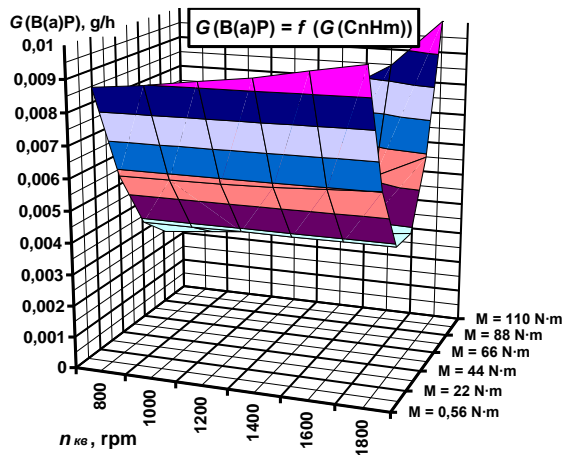

a

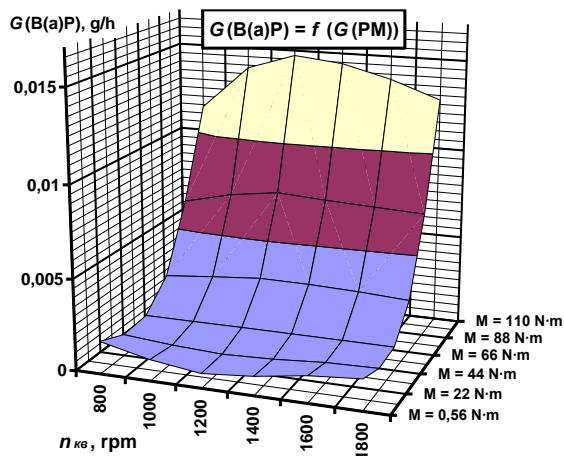

b

Figure 8 – Distribution of magnitudes of values $G(B(a)P) = f(G(C_nH_m))$ (a) and $G(B(a)P) = f(G(PM))$ (b) on operational regimes field of 2Ch10.5/12 autotractor diesel engine

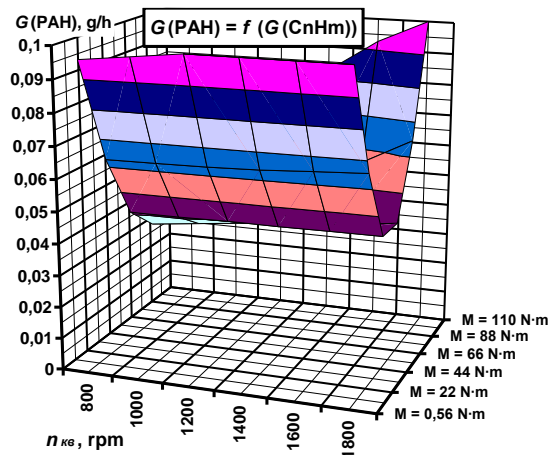

a

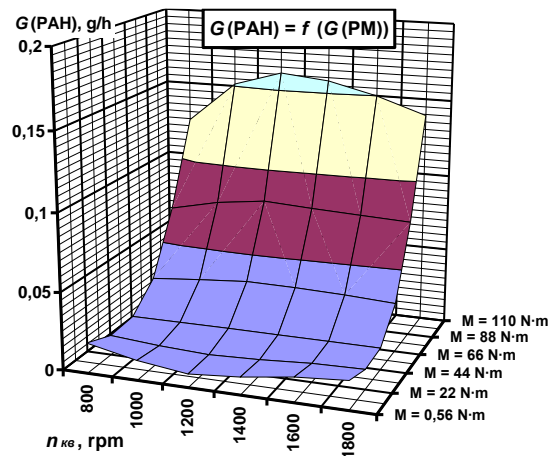

b

Figure 9 – Distribution of magnitudes of values $G(PAH) = f(G(C_nH_m))$ (a) and $G(PAH) = f(G(PM))$ (b) on operational regimes field of 2Ch10.5/12 autotractor diesel engine

At Fig. 9,b it can be seen that magnitude of value $G(PAH)$ repeating the pattern of distribution on operational regimes field of 2Ch10.5/12 diesel engine of magnitude of value $G(PM)$ reaches maximum equal to 0.175 g/h on regime of maximum torque and minimum equal to 0.020 g/h on regime in the middle of idle characteristics.

Distribution of individual regime magnitudes of values $G(B(a)P)$ and $G(PAH)$ for both of studied types of forms of distribution on 2Ch10.5/12 diesel engine operational regimes field for regimes of standardised steady testing cycle ESC is illustrated at Fig. 10.

For following calculation study following types of distribution were chosen: $G(B(a)P) = f(G(PM))$ and $G(PAH) = f(G(PM))$.

At Fig. 10 it can be seen that maximum magnitude of emissions $G(B(a)P)$ and $G(PAH)$ repeating the pattern of distribution on operational regimes field of 2Ch10.5/12 diesel engine of magnitude of value $G(PM)$ for regimes of testing cycle ESC is observed on regime of maximum torque (No. 2, $n_{cs} = 1250$ rpm, $M = 110$ N·m) and equal to 0.0145 g/h and 0.16 g/h respectively. On regime of nominal effective power (No. 10, $n_{cs} = 1750$ rpm, $M = 95$ N·m) such magnitudes

are 0.0095 g/h and 0.15 g/h. Minimal magnitude of emissions observed on regime of low effective power (No. 7, $n_{cs} = 1250$ rpm, $M = 27$ N·m) are 0.0007 g/h and 0.008 g/h. On regime of minimal idle (No. 1, $n_{cs} = 750$ rpm, $M = 0$ N·m) such magnitudes are 0.0018 g/h and 0.025 g/h.

In structure of formula (1) there is the mass emission of sulphur oxides SO_x in RICE EG flow. Magnitude of ponderability of such pollutant $A(SO_x)$ in this study were obtained from monograph [12] (see Table 1).

At Fig. 11 structure of ponderability of ES factors in ecological component of criterion K_{fe} is illustrated both with and without taking into account emission of SO_x .

Magnitude of mass hourly emission $G(SO_x)$ in this study obtained by using technique that was proposed by author in monograph [10].

At Fig. 12 distribution of magnitudes of value $G(SO_2)$ on operational regimes field of diesel engine 2Ch10.5/12 at the basic magnitude of coefficient $k_{SO_2} = 0.015$ is illustrated.

Such magnitude of coefficient k_{SO_2} obtained for magnitudes of mass concentration of sulphur in motor fuel $C_{sf} = 0.5$ %, in motor oil $C_{so} = 0.5$ % and at magnitude of relative costs of motor oil on fumes $C_{fo} = 0.5$ %.

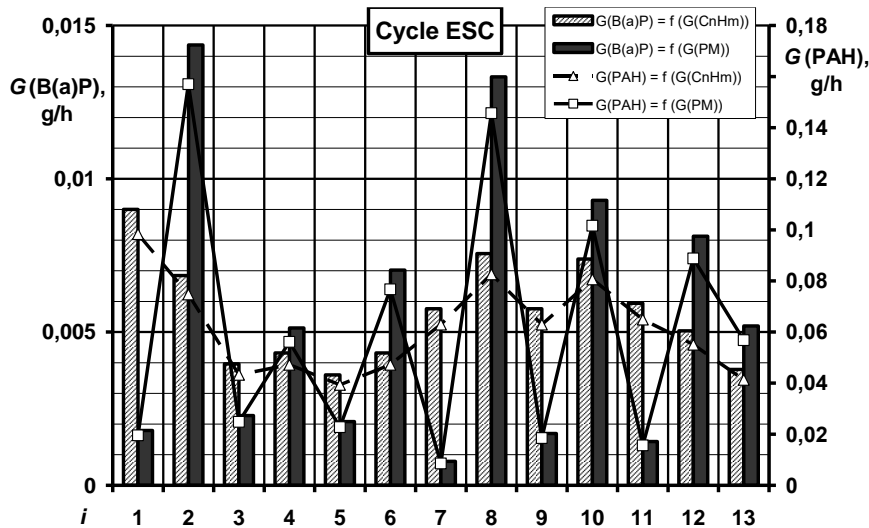

Figure 10 – Distribution of individual regime magnitudes of values $G(B(a)P) = f(G(C_nH_m))$ and $G(B(a)P) = f(G(PM))$, $G(PAH) = f(G(C_nH_m))$ and $G(PAH) = f(G(PM))$ for regimes of standardised steady testing cycle ESC 2Ch10.5/12 autotractor diesel engine

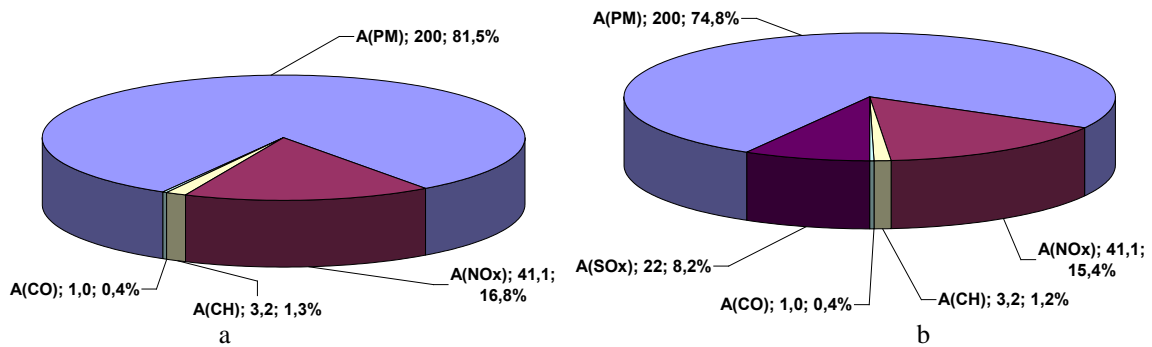

Figure 11 – Structure of ponderability of ES factors in ecological component of criterion K_{fe} taking into account of emission of SO_x (a) and without taking into account of such pollutant (b) [10]

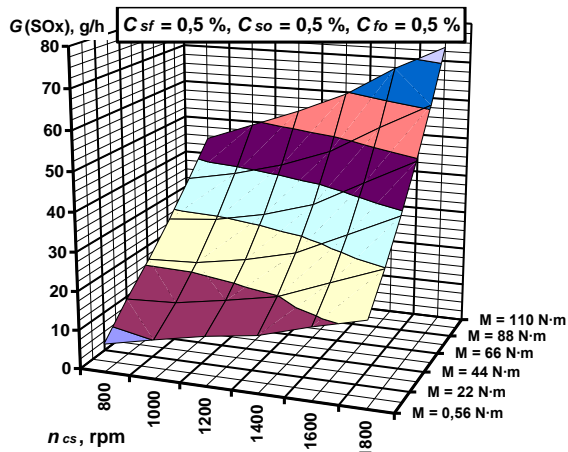

Figure 12 – Distribution of magnitudes of value $G(SO_2)$ on operational regimes field of diesel engine 2Ch10.5/12 at the basic magnitude of coefficient $k_{SO_2} = 0.015$ [10]

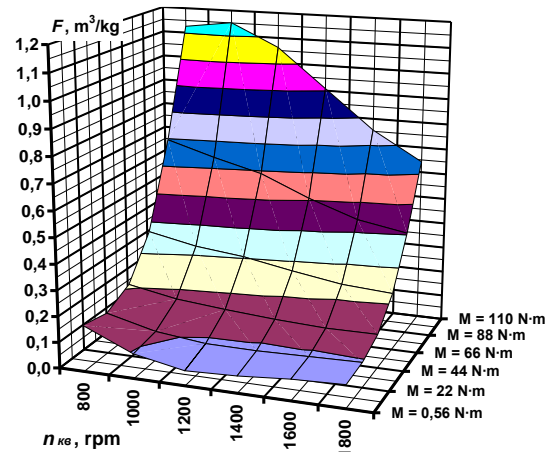

Figure 13 – Distribution of magnitudes of index F on operational regimes field of diesel engine 2Ch10.5/12

At Fig. 12 it can be seen that such distribution has nonlinear character and maximum magnitudes of emission $G(SO_2) = 75$ g/h are reached on regime of nominal effective power (when magnitudes of mass hourly consumption of motor fuel G_{fuel} and costs of motor oil on fumes also has maximum) and minimal magnitudes 6 g/h – on regime of minimal idle.

At Fig. 13 distribution of magnitudes of index F on operational regimes field of diesel engine 2Ch10.5/12 obtained by formula (1) is illustrated.

At Fig. 13 it can be seen that such distribution is uneven, minimal magnitude 0.058 (i.e. the one characterized with the highest ecology-chemical efficiency of 2Ch10.5/12 diesel engine exploitation

process) the index F is reached on regime in the middle of idle characteristic and maximum magnitude 1.151 (i.e. the one characterized with the lowest ecology-chemical efficiency of 2Ch10.5/12 diesel engine exploitation process) – on regime on external speed characteristic between regimes of maximum torque and nominal effective power.

At Fig. 14 distribution of magnitudes of value $G(\text{SO}_x)$ and $\delta\Sigma(A_k \cdot G_k)$ on regimes of testing cycle ESC for the basic variant of the study is illustrated.

At Fig. 14 it can be seen that maximum magnitudes of emission $G(\text{SO}_x) = 73 \text{ g/h}$ is observed on regime of nominal effective power (No. 10) and minimal 8 g/h – on regime of minimal idle (No. 1), so on regime of maximum torque (No. 2) such magnitude is 53 g/h.

At Fig. 15 distribution of magnitudes of index F on regimes of ESC testing cycle obtained by formula (1) is illustrated.

At Fig. 15 it can be seen that maximum magnitude of index $F = 1.029$ is reached on maximum torque regime (No. 2) and minimal $F = 0.091$ – on regime of low effective power (No. 7), on regime of nominal effective power (No. 10) $F = 0.500$ and on minimal idle regime (No. 1) – $F = 0.178$.

Middle exploitational magnitude of index F for ESC testing cycle obtained by formula (2) is 0.373.

It is necessary to note that from structure of formula (1) it can be seen that the larger the index F the lower the ES level of exploitation process of RICE on separate operational regime will be, unlike the complex fuel-ecological criterion of Prof. I.V. Parsadanov K_{fe} and generalized desirability function of K.E. Harrington D [10].

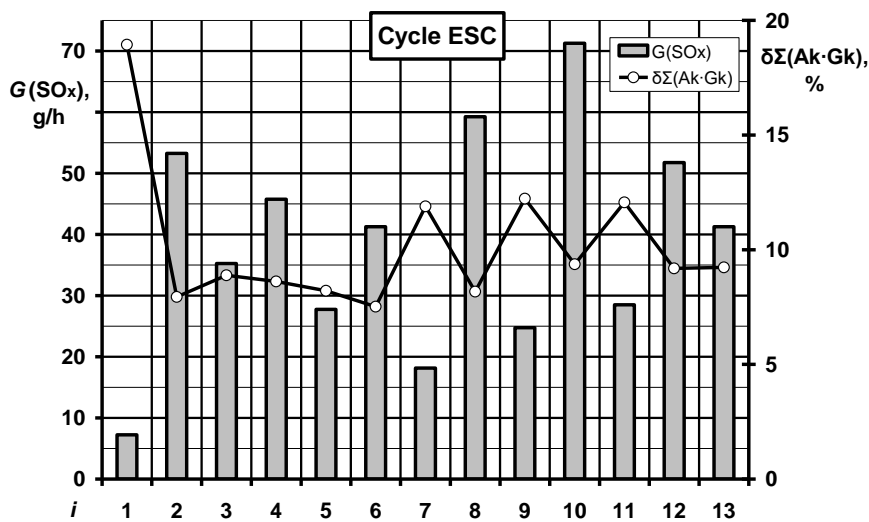

Figure 14 – Distribution of magnitudes of value $G(\text{SO}_x)$ and $\delta\Sigma(A_k \cdot G_k)$ on regimes of testing cycle ESC for the basic variant of the study [10]

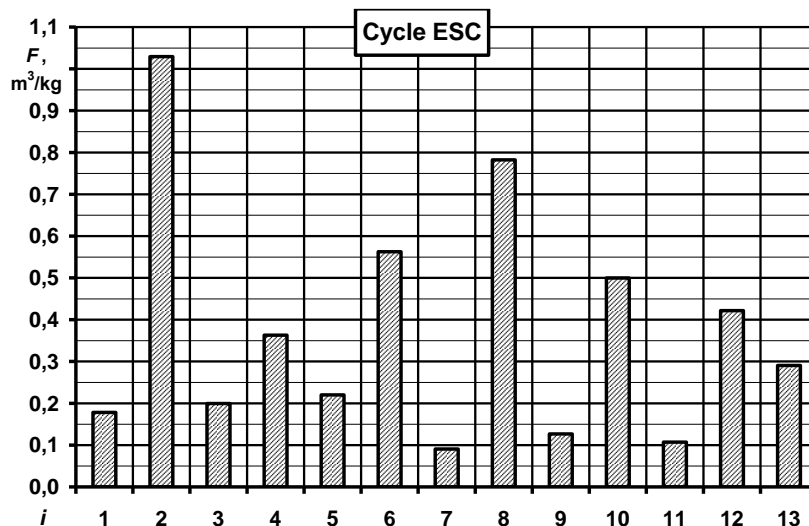

Figure 15 – Distribution of magnitudes of index F on regimes of testing cycle ESC

Conclusions

Thus, in this study a calculated assessment was made for the efficiency of exploitation process of vehicles with diesel RICE by determining the distribution of values of the integral index of ecological-

chemical evaluation of Prof. P.M. Kanilo, taking into account the emissions of sulphur oxides, benzo(a)pyrene and other PAH, both on the engine operating regimes field and in the regimes of the standardised steady test cycle ESC. At the same time, it

was proposed to improve the technique of determination of emissions of benzo(a)pyrene and other PAH based on analysis of the results of bench motor tests of 2Ch10.5/12 autotractor diesel engine and the scientific works of Prof. P.M. Kanilo.

It is established that, in case of considering of values of mass hourly emission of sulphur oxides, benzo(a)pyrene and other PAH in the criteria-based assessment of ES level of exploitation process of vehicles with diesel RICE with using of mathematical apparatus of the integral indicator of ecological-chemical evaluation, the minimum efficiency is characterized by the maximum torque regime (No. 2, $F = 1.029 = \max$), and by the maximum efficiency – regime with low effective power (No. 7, $F = 0.091 = \min$), the regime of nominal effective power – by average efficiency (No. 10, $F = 0.500$), and the minimal idle regime

(No. 1, $F = 0.178$) – by high efficiency. Middle exploitative magnitude of index F for the ESC standardised steady testing cycle is 0.373.

Acknowledgements.

The research was carried out in the science and research work of Applied Mechanics and Environmental Protection Technologies Department of National University of Civil Defence of Ukraine «Application of the apparatus of fuzzy logic and psychophysical scales in the criteria-based assessment of the level of ecological safety» (State Registration No. 0119U001001, 2019 – 2021).

Conflicts of Interest.

None of the authors has any potential conflicts of interest associated with this present study.

REFERENCES

- Zatserkivlyany, M. M. et al. (2017). Processes of protection of environment: textbook. Odesa, Publ. Feniks, 454.
- Apostolyuk, S. O., Djigirey, V. S., Sokolovsky, I. A. et al. (2012). Industrial ecology: tutorial, 2nd edition. Kyiv, Publ. Znannya, 430.
- Semenova, I. V. (2009). Industrial ecology: tutorial for students. Moscow, Publ. Akademia, 528.
- Vetoshkin, A. G., Tarantseva, K. R. (2004). Environment protection technology (theoretical basis), tutorial. Penza, Publ. PTI, 249.
- Kondratenko, O. M. (2019). Taking into account the emissions of CO₂ as a toxic pollutant and as a greenhouse gas in fuel and ecological complex criteria-based assessment of diesel-generator operation process. Technogenic and Ecological Safety, 6(2/2019), 12-23. doi: 10.5281/zenodo.3558960.
- Vambol, S. O., Stokov, O.P., Vambol, V. V., Kondratenko, O. M. (2015). Modern methods for increasing of ecological safety of power plants exploitation process: Monograph. Kharkiv, Publ. Style-Izdat, 212. Available: <http://repositsc.nuczu.edu.ua/handle/123456789/3529>.
- Kondratenko, O., Mishchenko, I., Chernobay, G., Derkach, Yu., Suchikova, Y.. (2018). Criteria based assessment of the level of ecological safety of exploitation of electric generating power plant that consumes biofuels. Book of Papers of 2018 IEEE 3rd International Conference on Intelligent Energy and Power Systems (IEPS–2018) (10–14 September 2018). Kharkiv, NTU «KhPI», 185-189. doi: 10.1109/IEPS.2018.8559570.
- Kondratenko, O. M. (2018). Selection of criterial apparatus for complex assessment of ecological safety level of exploitation process of power plants. Technogenic and Ecological Safety. Issue 3 (1/2018). P. 75–84. DOI: <http://doi.org/10.5281/zenodo.1182858>.
- Parsadanov, I. V. (2003). Improving the quality and competitiveness of diesel engines based on complex fuel and ecological criteria: Monograph. Kharkiv. Publ. Center NTU «KhPI». 244.
- Kondratenko, O. M. (2019). Metrological aspects of complex criteria-based assessment of ecological safety level of exploitation of reciprocating engines of power plants: Monograph. Kharkiv. Publ. Style-Izdat. 532.
- Bystrov, A. S., Varankiv, V. V., Vilensky, M. A. et al. (1986). Temporary standard methodology for determining the economic efficiency of environmental protection measures and assessing the economic damage caused to the national economy by environmental pollution. Moscow. Publ. Ekonomika. 96.
- Kanilo, P. M., Bey, I. S., Rovensky, O. I. (2000). Automobile and environment. Kharkiv, Publ. Prapor, 304.
- Kanilo, P. M. (1982). Toxicity of GTE and prospects of application of hydrogen. Kyiv, Publ. Naukova dumka, 140.
- Kanilo, P. M. (2013). Automotive transport. Fuel and ecological problems and prospects: monograph. Kharkiv, Publ. KhNADU, 270.
- Kanilo, P. M. (2015). Global climat warming. Anthropogenic and ecological reality: monograph. Kharkiv, Publ. KhNADU, 312.
- Ovcharov, O. V. (2000). Reduction of emissions of carcinogenic substances with exhaust gases of car gasoline engines: manuscript. Thesis of PhD dissertation, speciality 05.05.03, Kharkiv, IPMash NANU, 140.
- Sarapina, M. V. (2014). Fuel-economic and environmental indicators of fire vehicles engines on the example of tank trucks. Problems of fire safety, 36, 218-223.
- Kanilo, P. M., Kostenko, K. V., Sarapina, M. V. (2013). Minimizing the carcinogenic hazard of cars. Herald of KhNADU, 60, 133-142.
- Kanilo, P. M., Sarapina, M. V. (2012). The future of vehicles – alternative fuels and carcinogenic safety. Automotive transport, 31, 40-49.
- Kanilo, P. M., Shubenko, A. L., Kostenko, K. V., Sarapina, M. V. (2013). Analysis of European environmental requirements for passenger cars. Herald of KhNADU, 63, 67-75.
- Kanilo, P. M., Solovey, V. V., Sarapina, M. V. (2013). Anthropogenic and environmental factors of global warming. Energy saving. Energy audit, 8, 53-60.
- Kanilo P. M., Kostenko, K. V., Sarapina, M. V. (2013). Global energy-environmental problems and photosynthesis. Mechanical Engineering Problems, 16/4, 49-55.
- Liev tierov, A. M., Marakhovsky, V. P., Bgantsev, V. M., Sarapina, M. V. (2008). Experimental assessment of energy and environmental performance of a benzene ethanol car engine. Automotive transport, 22, 98-101.
- Kanilo, P. M., Kostenko, K. V., Sarapina, M. V. (2008). Ways to improve the environmental performance of cars using highly aromatic petroleum fuels. Automotive transport, 22, 31-37.
- Zvonov, V. A. (1981). Toxicity of internal combustion engines, 2nd edition, Moscow, Publ. Mashinostroyeniye, 160.
- Markov, V. A., Devjanin, S. N., Markova, V. V. (2014). Assessment of ecological safety of power plants with diesel engines. Safety on technosphere, 2, 23-32. doi: 10.12737/3668.
- Vambol, S., Vambol, V., Kondratenko, O., Koloskov, V., Suchikova, Y. (2018). Substantiation of expedience of application of high-temperature utilization of used tires for liquefied methane production. Journal of Achievements in Materials and Manufacturing Engineering, 87/2, 77-84. doi: 10.5604/01.3001.0012.2830.
- Vambol, S., Vambol, V., Sobyna, V., Koloskov, V., Poberezhna, L. (2018). Investigation of the energy efficiency of waste utilization technology, with considering the use of low-temperature separation of the resulting gas mixtures. Energetika. Vol 64. No 4 (2018). P. 186–195. doi: 10.6001/energetika.v64i4.3893.
- Kustov, M. V., Kalugin, V. D., Tutunik, V. V., Tarakhno, O. V. (2019). Physicochemical principles of the technology of modified pyrotechnic compositions to reduce the chemical pollution of the atmosphere. Voprosy Khimii i Khimicheskoi Tekhnologii, 1 (2019), 92-99. doi: 10.32434/0321-4095-2019-122-1-92-99.

30. Pospelov, B., Rybka, E., Meleshchenko, R., Gornostal, S., Shcherbak, S. (2017). Results of experimental research into correlations between hazardous factors of ignition of materials in premises. *Eastern European Journal of Enterprise Technologies*, 6 (10-90), 50-56. doi: 10.15587/1729-4061.2017.117789.
31. Pospelov, B., Rybka, E., Meleshchenko, R., Borodych, P., Gornostal, S. (2019). Development of the method for rapid detection of hazardous atmospheric pollution of cities with the help of recurrence measures. *Eastern-European Journal of Enterprise Technologies*, 1 (10-97), 29-35. doi: 10.15587/1729-4061.2019.155027.
32. Pospelov, B., Andronov, V., Rybka, E., Skliarov, S. (2017). Research into dynamics of setting the threshold and a probability of ignition detection by self-adjusting fire detectors. *Eastern European Journal of Enterprise Technologies*, 5(9-89), 43-48. doi: 10.15587/1729-4061.2017.110092.
33. Shvedun, V. O. (2015). Experience of EU countries in ensuring public administration of advertising activity. *Actual Problems of Economics*, 168 (6), 84-90.
34. Kondratenko, O. M., Kovalenko, S. A. (2019). Substantiation of choice of rational units of expression of monetary components of complex fuel-ecological criterion. *Electronic collection of scientific works «E-conomics»*, 1(3)/2019, 114-118. Available: <http://e-conomics.hpi.kh.ua/index.php/e-conomics/article/view/86/70>.
35. Polynuclear Aromatic Hydrocarbons. In: *Guidelines for Drinking-water Quality*, 2nd ed. Vol. 2. Health Criteria and other Supporting Information. Geneva, World Health Organization, pp. 123 – 152.: (page 11) «For ambient air, residential heating and vehicle traffic appear to be the main sources of exposure. In the direct vicinity of an emission source, a maximum intake of 1 µg of BaP per day may be reached (WHO, 1987; LAI, 1992).»
36. Mackay, D., Shiu, W. Y., Ma, K.-C., Lee, S. C. (2006). *Handbook of Physical-Chemical Properties and Environmental Fate for Organic Chemicals*, 2 ed., Vol. 1, Publ. CRC Press, 823-825.
37. Yalkowsky, S. H., Yan, H. (2003). *Handbook of aqueous solubility data*, Publ. CRC Press, 1188.
38. Uniform provision concerning the approval of compression ignition (C.I.) and natural gas (NG) engines as well as positive-ignition (P.I.) engines fuelled with liquefied petroleum gas (LPG) and vehicles equipped with C.I. and NG engines and P.I. engines fuelled with LPG, with regard to the emissions of pollutants by the engine: regulation United Nations Economic and Social Council Economics Commission for Europe Inland Transport Committee Working Party on the Construction of Vehicles of 26 January 2013 year Regulation No. 49, Revision 6. Geneva: UNECE, 2013, 434. Available: <https://www.unece.org/fileadmin/DAM/trans/main/wp29/wp29regs/2013/R049r6e.pdf>.
39. Efros V. V. et al. (1976). Diesel engines with air cooling of Vladimir tractor plant. Moscow, Publ. Mashinostroeniye, 277.

Кондратенко О. М.

ОЦІНЮВАННЯ ЕКОЛОГО-ХІМІЧНОЇ ЕФЕКТИВНОСТІ ПРОЦЕСУ ЕКСПЛУАТАЦІЇ ПОРШНЕВОГО ДВЗ ТРАНСПОРТНОГО ЗАСОБУ З УРАХУВАННЯМ ВИКИДІВ ОКСИДІВ СІРКИ, БЕНЗ(А)ПІРЕНА ТА ПОЛІЦИКЛІЧНИХ АРОМАТИЧНИХ ВУГЛЕВОДНІВ

У даному дослідженні вдосконалено запропоновані автором раніше методики визначення значення масових годинних викидів оксидів сірки, бенз(а)пірену та поліциклічних ароматичних вуглеводнів з потоком відпрацьованих газів дизельного двигуна. Отримано розподіли таких викидів по полю робочих режимів автотракторного дизеля 2Ч10,5/12 та по режимах стандартизованого стаціонарного випробувального циклу ESC. Вдосконалено математичний апарат та методику застосування індексу еколого-хімічної оцінки ДВЗ проф. П.М. Канило як альтернативи комплексному паливно-екологічно критерію проф. І.В. Парсаданова. Отримано розподіли значень цього показника рівня екологічної безпеки процесу експлуатації енергоустановок з поршневим ДВЗ по полю робочих режимів автотракторного дизеля 2Ч10,5/12 та по режимах стандартизованого стаціонарного випробувального циклу ESC, а також його середньоексплуатаційне значення. Встановлено, що за умови врахування значень масового годинного викиду оксидів сірки, бенз(а)пірену та інших ПАВ при критеріальному оцінюванні ефективності експлуатації автотранспортного засобу з поршневим ДВЗ за допомогою математичного апарату інтегрального показника екологохімічної оцінки, мінімальною ефективністю характеризується режим максимального крутного моменту ($\Phi = 1,029$), а максимальною ефективністю – режим з малою ефективною потужністю ($\Phi = 0,091$), режим номінальної ефективної потужності – середньою ($\Phi = 0,500$) ефективністю, а режим мінімального холостого ходу ($\Phi = 0,178$) – високою ефективністю. Середньоексплуатаційним значенням критерію Φ для циклу ESC та дизеля 2Ч10,5/12 є 0,373.

Ключові слова: екологічна безпека, технології захисту навколишнього середовища, енергетичні установки, поршневі двигуни внутрішнього згорання, викиди полутантів, критеріальне оцінювання, оксиди сірки, бенз(а)пірен, поліциклічні ароматичні вуглеводні.

ЛІТЕРАТУРА

1. Зацкеряний М. М., Зацкеряний О. М., Столевич Т. Б. Процеси захисту навколишнього середовища: підручник. Одеса: ОНАХТ, Фенікс, 2017. 454 с.
2. Апостолок С. О., В.С. Джигирей, І.А. Соколовський та ін. Промислова екологія: навчальний посібник. 2-ге вид., виправл. і доповн. К.: Знання, 2012. 430 с.
3. Семенова И. В. Промышленная экология: учеб. пособ. для студ. высш. учеб. заведений. М.: Изд. центр «Академия», 2009. 528 с.
4. Ветошкин А. Г., Таранцева К. Р. Технология защиты окружающей среды (теоретические основы). Учебное пособие. Пенза: Изд-во ППИ, 2004. 249 с.
5. Kondratenko O. M. Taking into account the emissions of CO₂ as a toxic pollutant and as a greenhouse gas in fuel and ecological complex criteria-based assessment of diesel-generator operation process. *Technogenic and Ecological Safety*, 2019. № 6 (2/2019). С. 12-23. doi: 10.5281/zenodo.3558960.
6. Вамболь С. О., Строков О. П., Вамболь В. В., Кондратенко О. М. Сучасні способи підвищення екологічної безпеки експлуатації енергетичних установок: монографія. Х.: ФОП Бровін О.В., 2015. 212 с. URL: <http://repositsc.nuczu.edu.ua/handle/123456789/3529> (дата звернення: 22.02.2020).
7. Kondratenko O., Mishchenko I., Chernobay G., Derkach Yu., Suchikova Ya. Criteria based assessment of the level of ecological safety of exploitation of electric generating power plant that consumes biofuels. *Book of Papers of 2018 IEEE 3rd International Conference on Intelligent Energy and Power Systems (IEPS-2018)* (10–14 September 2018, Kharkiv, NTU «KhPI»). Pp. 185-189. doi: 10.1109/IEPS.2018.8559570.
8. Kondratenko O. M. Selection of criterial apparatus for complex assessment of ecological safety level of exploitation process of power plants. *Technogenic and Ecological Safety*, 2018. No. 3 (1/2018). Pp. 75–84. doi: <http://doi.org/10.5281/zenodo.1182858>.
9. Парсаданов І. В. Підвищення якості і конкурентоспроможності дизелів на основі комплексного паливно-екологічного критерію: монографія. Х.: Центр НТУ «ХПІ», 2003. 244 с.
10. Кондратенко О. М. Метрологічні аспекти комплексного критеріального оцінювання рівня екологічної безпеки експлуатації поршневих двигунів енергетичних установок: монографія. Х.: ФОП Бровін О.В., 2019. 532 с. ISBN 966-593-319-1.
11. Быстров А. С., Варанкин В. В., Виленский М. А. и др. Временная типовая методика определения экономической эффективности осуществления природоохранных мероприятий и оценки экономического ущерба, причиняемого народному хозяйству загрязнением окружающей среды. М.: Экономика, 1986. 96 с.
12. Канило П. М., Бей І. С., Ровенський О. І. Автомобіль та навколишнє середовище. Х.: Прапор, 2000. 304 с.
13. Канило П. М. Токсичность ГТД и перспективы применения водорода. К.: Наукова думка, 1982. 140 с.
14. Канило П. М. Автотранспорт. Топливо-экологические проблемы и перспективы: монография. Х.: ХНАДУ, 2013. 270 с.

15. Канило П. М. Глобальное потепление климата. Антропогенно-экологическая реальность: монография. Х.: ХНАДУ, 2015. 312 с.
16. Овчаров О. В. Зниження викидів канцерогенних речовин з відпрацьованими газами автомобільних бензинових двигунів: дис. канд. техн. наук: спец.: 05.05.03 – теплові двигуни. Х.: ПМаш НАНУ, 2000. 140 с.
17. Сарапина М. В. Топливно-экономические и экологические показатели двигателей пожарных автомобилей на примере автоцистерн. *Проблемы пожарной безопасности*, 2014. Вып. 36. С. 218-223.
18. Канило П. М. Минимизация канцерогенной опасности автомобилей / П.М. Канило, К.В. Костенко, М.В. Сарапина // Вестник Харьковского национального автомобильно-дорожного университета. – 2013. – Вып. 60. – С. 133 – 142.
19. Канило П. М. Будущее автотранспорта – альтернативные топлива и канцерогенная безопасность / П.М. Канило, М.В. Сарапина // Автомобильный транспорт. – 2012. – Вып. 31. – С. 40 – 49.
20. Канило П. М., Шубенко А. Л., Костенко К. В., Сарапина М. В. Анализ европейских требований к экологической безопасности легковых автомобилей. *Вестник Харьковского национального автомобильно-дорожного университета*, 2013. Вып. 63. С. 67-75.
21. Канило П. М., Соловей В. В., Сарапина М. В. Антропогенно-экологические факторы глобального потепления климата. *Энергосбережение. Энергетика. Энергоаудит*, 2013. № 8. С. 53-60.
22. Канило П. М., Сарапина М. В., Костенко К. В. Глобальные энерго-экологические проблемы и фотосинтез. *Проблемы машиностроения*, 2013. Т. 16, № 4. С. 49-55.
23. Левтеров А. М., Мараховский В. П., Бганцев В. Н., Сарапина М. В. Экспериментальная оценка энерго-экологических показателей автомобильного двигателя на бензоэтаноле. *Автомобильный транспорт*, 2008. Вып. 22. С. 98-101.
24. Канило П. М. Костенко К. В., Сарапина М. В. Пути улучшения экологических показателей автомобилей при использовании высокоароматизированных нефтяных топлив. *Автомобильный транспорт*, 2008. Вып. 22. С. 31-37.
25. Звонков В. А. Токсичность двигателей внутреннего сгорания. 2-е изд., перераб. М.: Машиностроение, 1981. 160 с.
26. Марков В. А., Девянин С. Н., Маркова В. В. Оценка экологической безопасности силовых установок с дизельными двигателями. *Безопасность в техносфере*, № 2. 2014. С. 23-32. doi: 10.12737/3668.
27. Vambol S., Vambol V., Kondratenko O., Koloskov V., Suchikova Y. Substantiation of expedience of application of high-temperature utilization of used tires for liquefied methane production. *Journal of Achievements in Materials and Manufacturing Engineering*, 2018. Vol. 87. Issue 2. Pp. 77-84. doi: 10.5604/01.3001.0012.2830.
28. Vambol S., Vambol V., Koloskov V., Poberezhna L. Investigation of the energy efficiency of waste utilization technology, with considering the use of low-temperature separation of the resulting gas mixtures. *Energetika*, 2018. Vol 64, No 4 (2018). Pp. 186–195. doi: 10.6001/energetika.v64i4.3893.
29. Kustov M. V., Kalugin V. D., Tutunik V.V., Tarakhno O. V. Physicochemical principles of the technology of modified pyrotechnic compositions to reduce the chemical pollution of the atmosphere. *Voprosy Khimii i Khimicheskoi Tekhnologii*, 2019. No. 1 (2019). Pp. 92-99. doi: 10.32434/0321-4095-2019-122-1-92-99.
30. Pospelov B., Rybka E., Meleshchenko R., Gornostal S., Shcherbak S. Results of experimental research into correlations between hazardous factors of ignition of materials in premises. *EasternEuropean Journal of Enterprise Technologies*, 2017. No.6 (10-90). Pp. 50-56. doi: 10.15587/1729-4061.2017.117789.
31. Pospelov B., Rybka E., Meleshchenko R., Borodych P., Gornostal S. Development of the method for rapid detection of hazardous atmospheric pollution of cities with the help of recurrence measures. *Eastern-European Journal of Enterprise Technologies*, 2019. Vol. 1, No 10 (97). Pp. 29-35. doi: 10.15587/1729-4061.2019.155027.
32. Pospelov B., Andronov V., Rybka E., Skliarov S. Research into dynamics of setting the threshold and a probability of ignition detection by selfadjusting fire detectors. *EasternEuropean Journal of Enterprise Technologies*, 2017. No. 5 (9-89). Pp. 43-48. doi: 10.15587/1729-4061.2017.110092.
33. Shvedun V. O. Experience of EU countries in ensuring public administration of advertising activity. *Actual Problems of Economics*, 2015. № 168 (6). Pp. 84-90.
34. Кондратенко О. М., Коваленко С. А. Обґрунтування вибору раціональних одиниць вираження вартісних складових комплексного паливно-екологічного критерію. *Електронна збірка наукових праць «Е-КОНОМІКА»*, 2019. № 1(3)/2019. С. 114-118. – URL: <http://e-conomics.hpi.kh.ua/index.php/e-conomics/article/view/86/70> (дата звернення: 22.02.2020).
35. Polynuclear Aromatic Hydrocarbons. In: Guidelines for Drinking-water Quality, 2nd ed. Vol. 2. Health Criteria and other Supporting Information. Geneva, World Health Organization. Pp. 123-152.: (page 11) «For ambient air, residential heating and vehicle traffic appear to be the main sources of exposure. In the direct vicinity of an emission source, a maximum intake of 1 µg of BaP per day may be reached (WHO, 1987; LAI, 1992).»
36. Mackay D., Shiu W. Y., Ma K.-C., Lee S. C. Handbook of Physical-Chemical Properties and Environmental Fate for Organic Chemicals. 2 ed., Vol. 1. CRC Press, 2006. Pp. 823-825.
37. Yalkowsky S. H., Yan H. Handbook of aqueous solubility data. CRC Press, 2003. 1188 p.
38. Uniform provision concerning the approval of compression ignition (C.I.) and natural gas (NG) engines as well as positive-ignition (P.I.) engines fuelled with liquefied petroleum gas (LPG) and vehicles equipped with C.I. and NG engines and P.I. engines fuelled with LPG, with regard to the emissions of pollutants by the engine: regulation United Nations Economic and Social Council Economics Commission for Europe Inland Transport Committee Working Party on the Construction of Vehicles of 26 January 2013 year Regulation No. 49, Revision 6. Geneva: UNECE, 2013. 434 p. URL: <https://www.unece.org/fileadmin/DAM/trans/main/wp29/wp29regs/2013/R049r6c.pdf> (дата звернення: 22.02.2020)..
39. Эфрос В. В. и др. Дизели с воздушным охлаждением Владимирского тракторного завода. М.: Машиностроение, 1976. 277 с.

ЗМІСТ

Kozulia T., Kozulia M., Didmanidze I. COMPREHENSIVE STUDY OF THE SYSTEMIC FORMATION «OBJECT–ENVIRONMENT» SECURITY STATE	3
Андронов В. А., Макаров Є. О., Данченко Ю. М., Обіженко Т. М. ДОСЛІДЖЕННЯ ЗАКОНОМІРНОСТЕЙ ФОРМУВАННЯ ТА ХІМІЧНОГО СКЛАДУ СТИЧНИХ ВОД МОЛОКОПЕРЕРОБНОГО ПІДПРИЄМСТВА	13
Azarov S., Mashkov V., Shevchenko R., Shcherbak S. METHODOLOGY FOR THE ECOLOGICAL ENVIRONMENTAL IMPACT ASSESSMENT OF THE FOREST FIRE CONSEQUENCES UNDER COMPLEX RADIATION CONDITIONS OF FIRE LOAD	22
Гурбанова М. А., Лобойченко В. М., Шевченко Р. И., Дадашов И. Ф. АНАЛИЗ ЭКОЛОГИЧЕСКИХ ХАРАКТЕРИСТИК ОСНОВНЫХ ОРГАНИЧЕСКИХ КОМПОНЕНТОВ ПЕНООБРАЗОВАТЕЛЕЙ, ИСПОЛЬЗУЕМЫХ В ПОЖАРОТУШЕНИИ	27
Kondratenko O. ASSESSMENT OF ECOLOGICAL AND CHEMICAL EFFICIENCY OF EXPLOITATION PROCESS OF RECIPROCATING ICE OF VEHICLE WITH CONSIDERATION OF EMISSION OF SULPHUR OXIDES, BENZO(a)PYRENE AND POLYCYCLIC AROMATIC HYDROCARBONES	38
Пономаренко Р. В., Пляцук Л. Д., Третьяков О. В., Черкашин О.В., Затько Й. ПРОГНОЗУВАННЯ ПОКАЗНИКІВ КИСНЕВОГО РЕЖИМУ ПОВЕРХНЕВОГО ДЖЕРЕЛА В УМОВАХ ВОДНОЇ ЕКОСИСТЕМИ БАСЕЙНУ ДНІПРА	51
Соколова В. І., Крусір Г. В., Сагдєєва О. А., Коваленко І. В., Кузнецова І. О. ДОСЛІДЖЕННЯ ВПЛИВУ МІКРОБІОЛОГІЧНОЇ ДОБАВКИ «БАЙКАЛ ЕМ» НА ПРОЦЕС КОМПОСТУВАННЯ СУМІШІ ХАРЧОВИХ ВІДХОДІВ	57

TABLE OF CONTENT

Kozulia T., Kozulia M., Didmanidze I. COMPREHENSIVE STUDY OF THE SYSTEMIC FORMATION «OBJECT–ENVIRONMENT» SECURITY STATE	3
Andronov V., Makarov Ye., Danchenko Yu., Obigenko T. RESEARCH OF THE REGULARITIES OF FORMING AND CHEMICAL COMPOSITION OF SEWAGE WATER OF A DAIRY PROCESSING COMPANY	13
Azarov S., Mashkov V., Shevchenko R., Shcherbak S. METHODOLOGY FOR THE ECOLOGICAL ENVIRONMENTAL IMPACT ASSESSMENT OF THE FOREST FIRE CONSEQUENCES UNDER COMPLEX RADIATION CONDITIONS OF FIRE LOAD	22
Gurbanova M., Loboichenko V., Shevchenko R., Dadashov I. ANALYSIS OF ENVIRONMENTAL CHARACTERISTICS OF THE BASIC ORGANIC COMPONENTS OF THE FOAMING AGENT USED IN FIRE FIGHTING	27
Kondratenko O. ASSESSMENT OF ECOLOGICAL AND CHEMICAL EFFICIENCY OF EXPLOITATION PROCESS OF RECIPROCATING ICE OF VEHICLE WITH CONSIDERATION OF EMISSION OF SULPHUR OXIDES, BENZO(a)PYRENE AND POLYCYCLIC AROMATIC HYDROCARBONES	38
Ponomarenko R., Plyatsuk L., Tretyakov O., Cherkashyn O., Zat'ko J. FORECASTING OF OXYGEN MODE OF SURFACE SOURCES IN CONDITIONS OF THE WATER ECOSYSTEM OF THE DNIPRO BASIN	51
Sokolova V., Sagdeeva O., Krusir G., Kovalenko I., Kuznetsova I. RESEARCH OF THE IMPACT OF THE BAIKAL EM MICROBIOLOGICAL SUPPLEMENT ON THE COMPOSTING OF MIXED FOOD WASTE	57

Наукове видання

Науково-технічний журнал
«ТЕХНОГЕННО-ЕКОЛОГІЧНА БЕЗПЕКА»

Випуск 7(1/2020)

Головний редактор В. А. Андронов

Відповідальний секретар В. Ю. Колосков