

PAPER • OPEN ACCESS

## Investigation of the Stability Conditions of an Automated Control System for a Centrifugal CVT of Automotive Special Equipment

To cite this article: V. Lytovchenko *et al* 2021 *IOP Conf. Ser.: Mater. Sci. Eng.* **1164** 012046

View the [article online](#) for updates and enhancements.

# Investigation of the Stability Conditions of an Automated Control System for a Centrifugal CVT of Automotive Special Equipment

V. Lytovchenko<sup>1,\*</sup>, M. Pidhornyy<sup>1</sup>, M. Bondarenko<sup>1</sup>, I. Fedyuk<sup>2</sup> and O. Shapovalov<sup>3</sup>

<sup>1</sup>Cherkasy State Technological University (ChSTU), 460, Shevchenko blvd., Cherkasy 18006, Ukraine

<sup>2</sup>National University of Civil Defense of Ukraine, 94, Chernyshevskaya str., Kharkiv 61023, Ukraine

<sup>3</sup>National Academy of National Guard of Ukraine, 3, Square of the Defenders of Ukraine, Kharkiv, 61023, Ukraine

\*E-mail: akronimail@gmail.com

**Abstract.** Modern continuously variable mechanical transmissions (CVT) with V-belt variators change the gear ratio due to tangential forces. In most cases, both the input and the initial links are geometrically similar wedge disks that move in a linear mode along their axis of rotation, while the process of controlling the transformation of the gear ratio is realized individually for each of the proposed solutions. The authors suggest employing direct action forces, the centrifugal force of the CVT working elements and the variator for transformation, instead of the traditionally used tangential forces. The use of the methods specified above allows reducing power loss by means of mechanical self-regulation of the continuously variable transmission.

## 1. Introduction and literature review

Over the past decades, automated hydraulic and hydrostatic, robotic gear shifting systems (GSS) and variators have been widely used in vehicles. Modern GSSs have temporary losses in power flow from the engine to the drive wheels. This disadvantage significantly affects the issue of vehicle transmission automation. Automated hydraulic GSSs have low efficiency, super-complex hydraulic systems, expensive workers and control bodies. Therefore, the demand for systems using hydraulics is decreasing and demand for mechanical systems is increasing.

Modern automatic V-belt variators of vehicles are structurally equipped with regulators. These are centrifugal regulators for changing the gear ratio [1, 2]. But the kinematic scheme of variators is based on an irrational transformation of centrifugal force. The use of continuously variable transmissions would be advisable for automatically operating systems. Ensuring the continuity of transmission control and the possibility of its application without stopping the vehicle makes it easy to automate control. That is why the use of self-regulated transmissions is currently one of the most promising areas in the development of new transmission types.

## 2. Literature review

Among the existing SV there are non-automatic, semi-automatic and automatic [4]. The disadvantage of analogs is that they are automatic or semi-automatic only in the manner of controlling the transmission and changing the gear ratio, but not in terms of adaptability to replaceable factors of influence on the transmission and not in terms of control stability, which makes it impossible for the existence of a feedback of engine transmission control. This contradicts the main purpose of the vehicle's automatic control system - to provide control of both the engine and transmission with one



control element (pedal, lever, etc.) [5]. This condition allows the engine to do at a constant optimal mode, and the transmission to transmit the necessary power to the drive wheels, depending on the resistance of movement, which allows you to obtain high traction, speed and fuel and economic characteristics of the vehicle

In his work O. I. Dubinets considers the conditions of static equilibrium of the pulleys of the driven and driving links of V-belt variators with the use of regulators [6]. The centrifugal regulator combines two important control properties: to create an increased axial force and to adjust the axial force depending on the frequency of rotation of the pulley.

In the work of N. M. Filkin and S. A. Shvetsova, another image of the imposition of the axial force of the centrifugal regulator of the driven link at idle operation is shown [7].

An atypical solution of the CVT design without additional regulators considered in the work of I.P. Zgonnik [8]. Here is a variant of the technical solution of the V-belt variator, the geometric shape of the pulley of one or both links, this is a single-lane hyperboloid of rotation. The idea here is to basically rotate the active axle with a variable diameter wheel (main wheel) and use the rotation frequency value that is transformed in the active axle to rotate the centrifugal governor, which in turn changes the gear ratio. During this cycle, the levers of the centrifugal governor move outward or inward relative to the spring, depending on the speed of rotation.

### **3. Materials of research**

The object of the study was a new CVT developed at the Department of Automobiles and Technologies for Their Operation, Cherkasy State Technological University, Ukraine. For its mechanical properties, it is similar to existing V-belt or chain drives. The essential difference lies in the way the gear ratio is changed. It consists in the use of centrifugal force, both of the working effort and of the manager. The control method refers to adaptive mechanisms. It can be used on small classes of cars and on motor vehicles. The simplified circuit and structure of the variator simplifies the assembly process and reduces the cost.

### **4. Methods of research**

The synthesis of mechanisms is a crucial stage in the creation of a future variator. Synthesis is a complex problem with different solutions. Therefore, additional analysis is required to select the most appropriate option. The ambiguity of decisions during the synthesis occurs due to the fact that: firstly, at the stage of developing the technical specifications for the creation of a new mechanism (variator), as usual, it is impossible to correctly and unambiguously formulate the requirements that apply to it; secondly, the same conditions can be reproduced both by several mechanisms different in structure, and by one mechanism, which have different sizes of variator links.

Traditionally, the synthesis of mechanisms [2, 9] is carried out in the following two stages: the structure of the future mechanism is determined (structural synthesis). Designing such a structural diagram of the mechanism, on which the base, moving links, types of kinematic pairs and their mutual arrangement are indicated; for the given kinematic or dynamic properties of the mechanism, the sizes of its links are determined - parametric synthesis.

### **5. Study of the kinematic scheme and the principle of operation of the physical model**

The authors have developed a CVT, which satisfies these conditions (Figure 1, a, b) [1, 2].

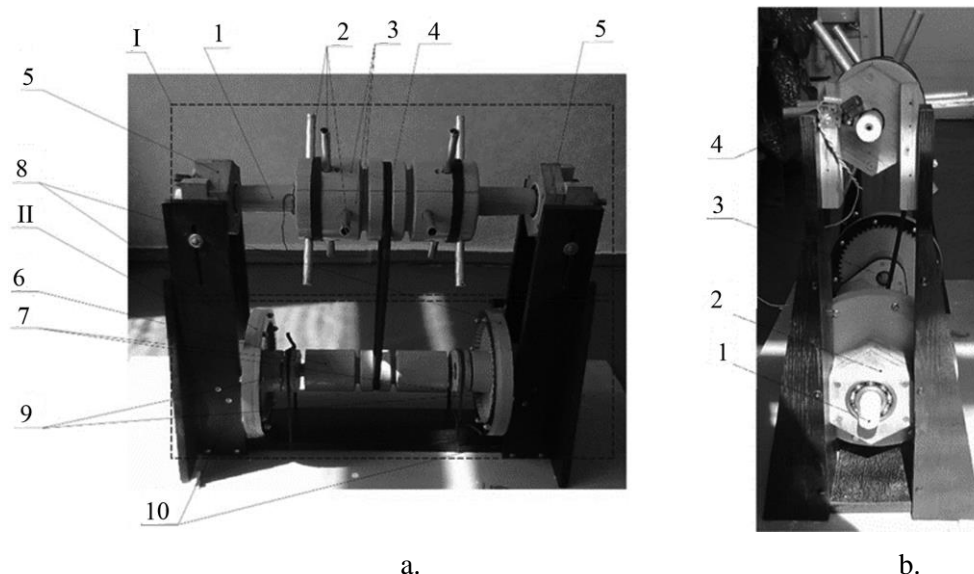

**Figure 1.** Research facility as a physical model of a centrifugal variator: front view (a); left side view (b): I – multiplication link; II – reduction link; 1 – input shaft; 2 – guides; 3 – sliding sectors of the driving pulley; 4 – belt; 5 – resistance of the input shaft; 6 – shaft-gear; 7 – drive; 8 – cogwheel; 9 – exit shaft; 10 – racks.

At its core, the installation is a physical model of a centrifugal variator and is intended to demonstrate the operation of the device, and not for practical implementation. However, the current model allows experimental research. Structurally, the multiplication link is made up of the input shaft 1, guides 2, sectors of the drive pulley 3, belt 4 and supports to the shaft 5. The guides are rigidly connected from the feathers by the guilty shaft and wrap with it. The drive pulley sectors can move freely along the guides, but their extreme position is determined by the limiters. The wedge pass covers the sectors of the drive pulley, the tension on the belt also limits their movement by a certain measure. The transmission of torque and frequency of rotation occurs in the following order. The engine wraps shaft 1, the torque is transmitted to the multiplication link of the transmission. The input shaft 1 wraps around the guides 2, which are rigidly fixed on it. They, in turn, wrap the sectors of the driving pulley 3. The torque from the driving pulley is transmitted to pass 4, which connects the animation and reduction links.

The reduction link is made up of a driven pulley 5, a gear shaft 6, a carrier 7, a gear wheel 8, a secondary shaft 9, a belt and supports 10. The driven pulley is rigidly fixed to the shaft - gear. Shaft is a gear fixed to the carrier, which can turn around the axis of the secondary shaft. The gear wheel is in constant engagement with the pinion shaft and increases the torque that is transmitted from the multiplier link by a fixed amount.

A special class of automated control systems (ACS) is formed by systems to which the system proposed by the authors belongs and are capable of automatically adapting to changes in external conditions and properties of the controlled object, while ensuring the necessary quality of control by changing the structure and parameters of the controlled device [2]. They are called adaptive. As part of an adaptive (which are adapted by systems) ACS should not contain additional control devices. The device must perform the algorithm of functioning independently [9]. The algorithm for the functioning of an adaptive ACS, as usual, suggests maximizing the quality indicator, which characterizes either the properties of the control process in the ACS as a whole (speed, accuracy, and so on), or the properties of the processes that occur in the control object (productivity, achieving the highest efficiency, minimizing costs etc.). Therefore, adaptive ACS are also optimal.

The physical model described above became the basis of the prototype, on which tests were carried out in the mode of start from a place and straight motion at a distance of 200 g. The test brought the

performance of a new continuously variable mechanical transmission based on a centrifugal variator (Fig. 1, a). According to the force distribution scheme (Fig. 1, b), we determine the gear ratio of the new V-belt variator.

At the beginning of the design of the scheme for the distribution of work and control efforts, it is necessary to describe the balance equation of the efforts of the input and output links [9]. Working forces include the centrifugal force of the sliding pulley, centrifugal force of the flex member (belt), belt tension, wedging force between the guide and the sliding pulley, load on the original shaft, and the weight of the driven pulley. The control forces include: the centrifugal force of the flexible element (belt), the load on the original shaft.

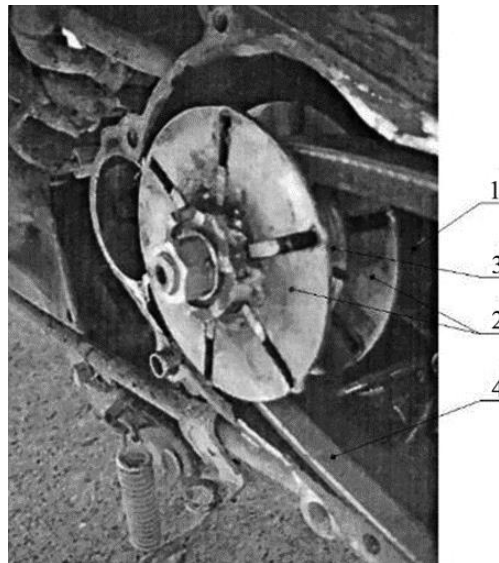

**Figure 2.** General view of the centrifugal link of the V-belt variator of the Honda Tact AF-24 scooter: 1 – engine; 2 – guide disks of the sliding pulley segments; 3 – segments of a sliding pulley; 4 – belt.

Let us indicate the equation that describes each effort:

Centrifugal force of one sliding pulley:

$$F_{CFS} = m \cdot \omega^2 \cdot R, \tag{1}$$

where  $m$  is the pulley weight, g;  $\omega$  will be angular velocity of the input shaft in Hz;  $R$  is the radius of the sliding pulley's position in mm.

Centrifugal belt force:

$$F_{CFB} = m_1 \cdot \omega^2 \cdot R_1 \cdot \sin\beta, \tag{2}$$

where  $m_1$  is the mass of the part of the belt limited by angle  $\beta$ , g;  $\omega$  is angular velocity of the input shaft, Hz;  $R_1$  is belt radius, mm;  $\beta$  is the belt's looping angle of the pulley, deg.

Centripetal force of one sliding pulley:

$$F_{CPF} = \frac{m \cdot v^2}{R}, \tag{3}$$

where  $m$  is the pulley weight, g;  $v$  is the sliding pulley's linear speed, mm/min;  $R$  is the position radius of the sliding pulley, mm.

Belt tension force:

$$F_{\text{BTF}} = 500 \cdot \frac{(2,5 - C_a) \cdot P_{\text{DP}} \cdot C_p}{C_a \cdot v} + m_a \cdot v_1^2, \quad (4)$$

where  $m_a$  is the belt's length weight, g;  $C_a$  is the looping angle coefficient;  $C_p$  is the dynamic load and single-shift operating mode coefficient;  $P_{\text{DP}}$  is the rated drive power, N;  $v_1$  is the belt's linear speed, mm/min.

The wedging force of one sliding centrifugal pulley link:

$$F_{\text{WF}} = n \cdot F_N \cdot \frac{1}{3} \cdot \kappa, \quad (5)$$

where  $n$  is summary points of contact between the guide rail and the sliding pulley;  $F_N$  is the normal force acting on the pulley, N;  $\kappa$  is the gearing coefficient.

Output shaft load. It is defined as the moment of resistance on the output shaft:

$$P = F_F \cdot R_{\text{OS}}, \quad (6)$$

where  $R_{\text{OS}}$  is the output pulley's radius, mm;  $F_F$  is the friction force between the shaft and the load element:

$$F_F = F_N \cdot f. \quad (7)$$

where  $F_N$  is the normal force acting on the pulley, N;  $f$  is the coefficient of friction (here accepted as  $f = 0,6$ ). By substituting the values in formula 6, we will get the following equation:

$$P = F_N \cdot f \cdot R_{\text{OS}}. \quad (8)$$

Taking into account the direction of the force vectors (Fig. 1, b) and carrying out the transformation of the indicated equations (1-8), we obtain the equation of the centrifugal force of one sliding pulley:

$$F_{\text{CFS}} = \frac{\omega_{\text{out}} \cdot m \cdot \omega \cdot R_{\text{OS}}}{R}. \quad (9)$$

The total gear ratio of the variator is defined as the difference between the input power and the original power. Input power is the product of the engine shaft torque with the shaft rotation frequency. Power output is the product of the scooter's drive wheel torque times the rpm. Knowing that the torque is the product of torque to frequency, we get the equation to determine the overall gear ratio:

$$i_T = \frac{z \cdot m}{P}, \quad (10)$$

where  $z$  is the number of sliding segments of the variator centrifugal link, pcs;  $m$  - the mass of the sliding pulley, g;  $P$  - output shaft load, N.

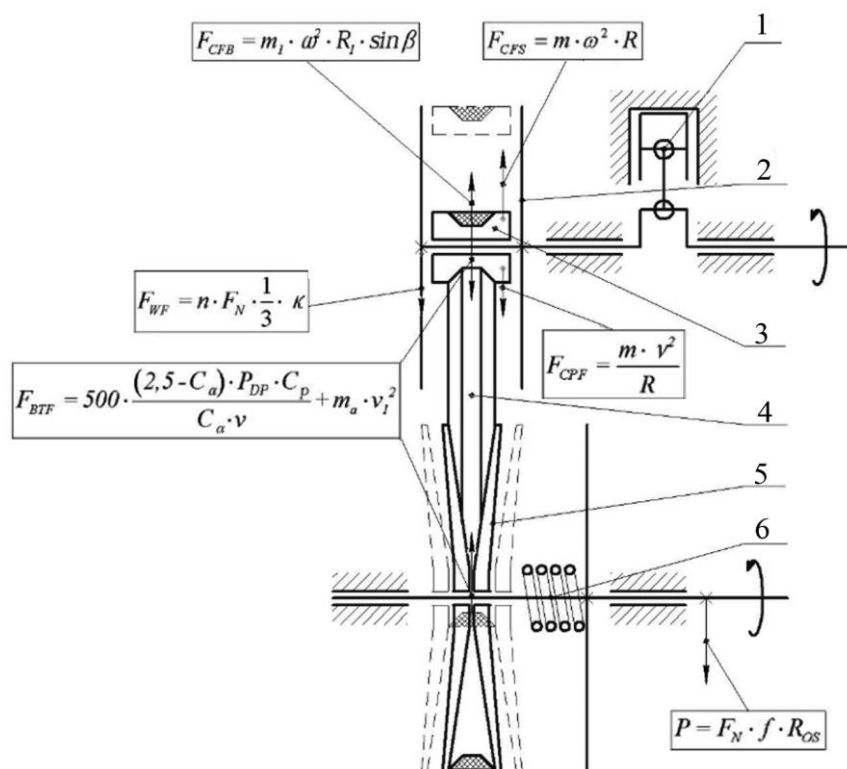

**Figure 3.** Diagram of the distribution of the working and control forces of the variator with the centrifugal link of the Honda Tact AF-24 scooter: 1 – engine; 2 – guide disks of the sliding pulley segments; 3 – segments of a sliding pulley; 4 – pass; 5 – sliding disks of the output link of the variator; 6 – variator centrifugal clutch.

### 6. Study of the dynamics of mass loss of quartz dispersed materials

The authors carried out research on adaptive ACS. Checking the operation of the physical model of the CVT. The results of these studies are presented in this check-list (stages of the experiment):

- 1) Idle start without changing the engine speed;
- 2) Idle start at minimum engine speed;
- 3) No-load start with a change in the engine speed;
- 4) Continuous work with load;
- 5) Constant load start;
- 6) Replaceable load start;
- 7) Stop mode of the mechanism to loads (braking of the driving wheel);
- 8) The mode of stopping the mechanism with the engine off without load.

Note that the adaptation can only be checked during continuous operation with load. All other modes simulate the operation of CVT on a vehicle and test the results of theoretical studies. For the load of the system, which is being investigated, we take three levels. The first level is no load, the second is at partial load, and the third is at the maximum load allowed by the drive engine.

Durability of a linear system with a characteristic equation:

$$a_3 \cdot p^3 + a_2 \cdot p^2 + a_1 \cdot p + a_0 = 0 \tag{11}$$

the necessary fulfillment of two conditions:

- 1) All coefficients of the characteristic equation must be positive;
- 2) The product of the average coefficients must be greater than the product of the extreme coefficients

$$a_1 \cdot a_2 > a_0 \cdot a_3 \tag{12}$$

The coefficients of the equation include only the values of the parameters of the system, therefore, the resistance of the latter is determined only by the parameters and does not depend on its mill. The tables of the results of the experiment (table 1) have the following structure. In the left column there are written circulation frequencies, which are given to the input shaft and are recorded by a frequency meter. The top line shows the values of the load on the original shaft. In the place of the section of the corresponding row and column, the recorded measurement results for each of the three replicas. Based on the measurement results, we calculate the arithmetic mean value for each mill of the system and accept it as valid for further calculations. The above table is compiled for each objective function. Further, using the table in which the already recorded research results, we build a Microsoft Office Excel graph (Fig. 4) of the required dependencies.

For the dependence of the output shaft rad/s on the rad/s of the input shaft, it is necessary to carry out an approximation to the polynomial form and examine it for movement resistance using Vishnegradskiy's criteria.

**Table 1.** Measurement of the ratio of the frequency of revolutions of the output and input shafts.

Time [s]	The frequency of rotation of the crankshaft of the internal combustion engine [rad/s]	The frequency of rotation of the driving wheel [rad/s]	The frequency of rotation of the crankshaft of the internal combustion engine [rpm.] (at a load of 40 [N·m])	The frequency of rotation of the driving wheel [rpm.] (at a load of 40 [N·m])
1	2	3	4	5
1	5.429	0	531.783	54.4
2	47.67	1.1333	530.816	55.533
3	89.906	2.2667	529.463	56.667
4	132.13	3.4	527.818	57.8
5	174.337	4.5333	525.882	58.933
6	216.521	5.6667	523.657	60.067
7	258.677	6.8	521.145	63.267
8	300.798	7.9333	518.349	64.4
9	342.881	9.0667	515.274	65.533
10	384.918	10.2	511.926	66.667
11	426.904	11.333	508.313	67.8
12	468.835	12.467	504.442	68.933
13	514.402	13.6	500.324	70.067
14	583.452	14.733	494.572	71.2
15	653.327	15.867	491.59	72.333
16	681.569	17	493.266	73.467



1	2	3	4	5
17	686.546	18.133	494.932	74.6
18	682.627	19.267	496.59	75.733
19	675.545	20.4	498.238	76.867
20	666.989	21.533	499.877	78
21	658.357	23.5	503.028	79.133
22	650.42	25.05	506.415	80.267
23	641.807	26.6	509.834	81.4
24	634.095	28.15	513.291	82.533
25	626.24	29.7	516.787	83.667
26	619.663	31.25	520.327	84.8
27	612.223	32.8	523.914	85.933
28	606.549	34.35	527.55	87.067
29	599.717	35.9	531.238	88.2
30	593.206	37.45	534.98	89.333
31	588.971	39	538.776	90.467
32	583.598	40.55	546.535	91.6
33	577.02	42.1	550.498	92.733
34	570.598	43.65	554.514	93.867
35	566.558	45.2	558.582	95
36	563.219	46.75	562.698	96.133
37	559.134	48.3	566.859	97.267
38	554.304	49.85	571.06	98.4
39	548.737	51.4	575.295	98.592
40	542.457	52.95	579.558	98.717
41	536.297	53.267	601.044	99.042

Based on the measurement results, we plot the graphs of the dependences  $n_{out} = f(n_{in})$  [rad/s]. These graphs are shown in Figure 4-7.

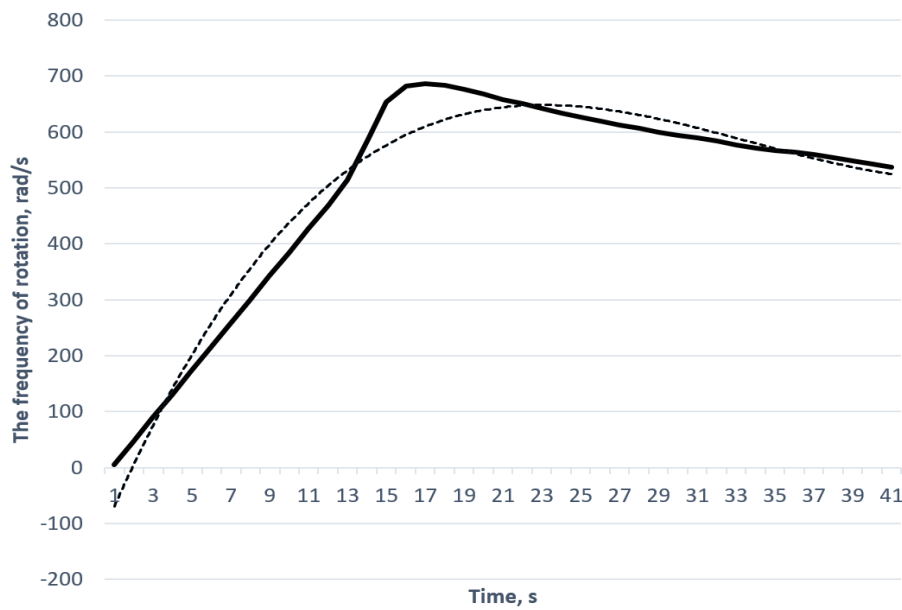

**Figure 4.** Graph of changes in the frequency of rotation of the engine shaft. Approximation of dependence plots.

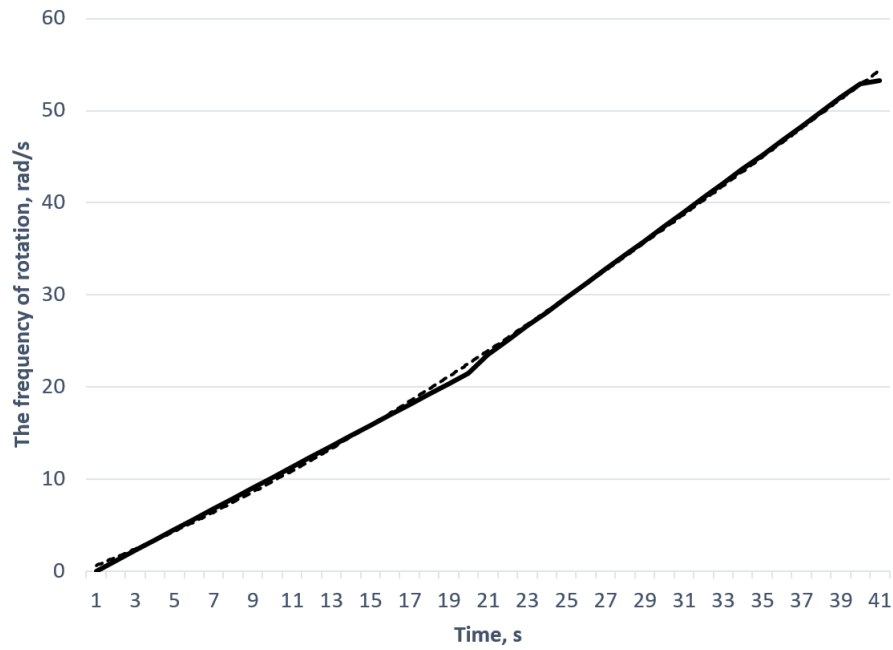

**Figure. 5.** Graph of changes in the frequency of rotation of the drive wheel. Approximation of dependence plots.

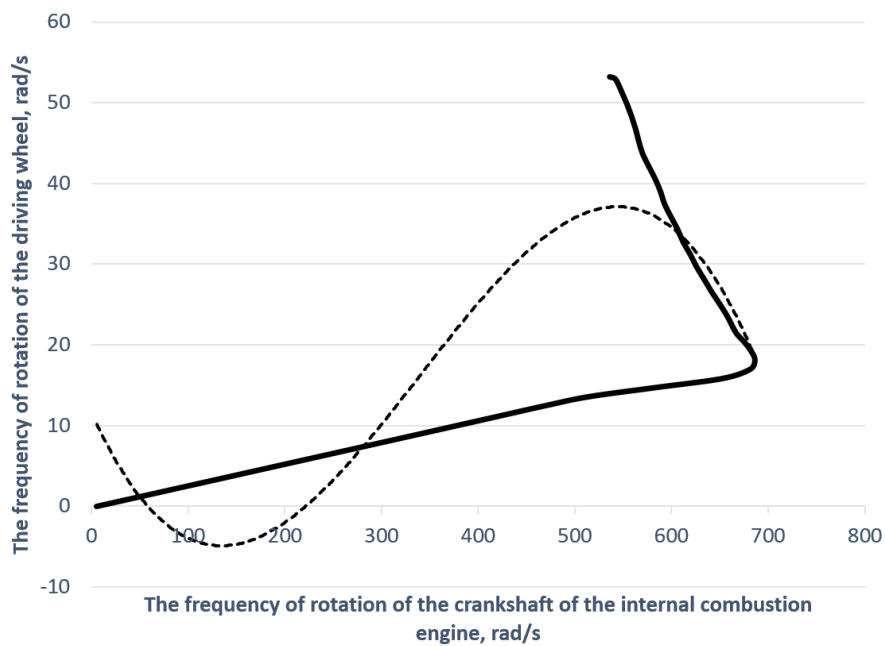

**Figure. 6.** Graph of the dependence of the frequency of rotation of the engine shaft to the frequency of rotation of the driving wheel. Approximation of dependence plots.

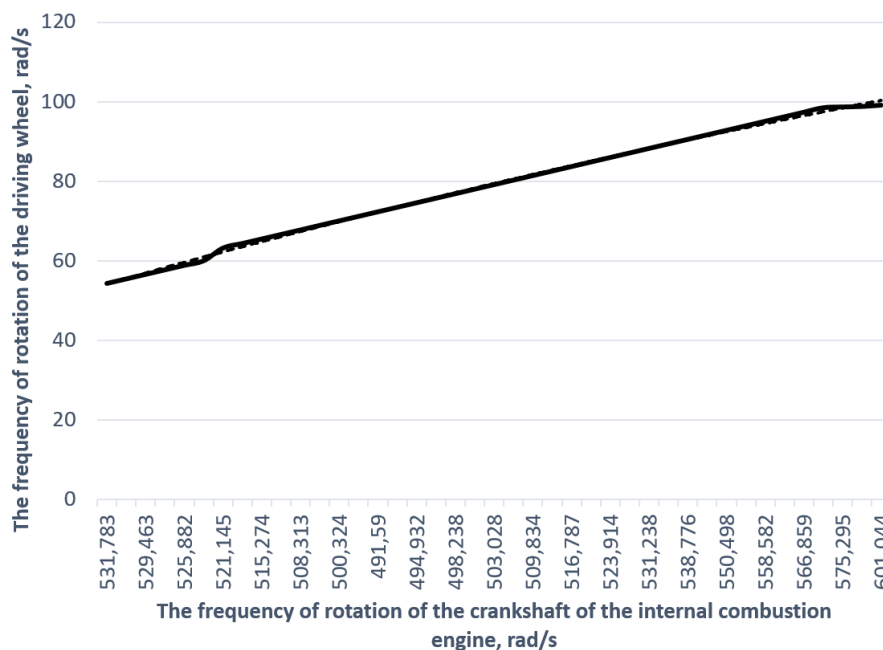

**Figure 7.** Graph of the dependence of the frequency of rotation of the engine shaft to the frequency of rotation of the driving wheel (at a load of 40 [N.m]). Approximation of the graphs of dependence.

**7. Study the durability of the variator**

The obtained characteristic equations of the CVT control system must be checked for durability.

To study the stability of the system, we choose the criterion of Vishnegradsky's resistance as such, which allows us to conduct a reliable study and is quite easy to use.

Vishnegradskiy's resistance criteria are as follows:

1) All coefficients of the polynomial characteristic equation of the system must be positive. As can be seen from the equations shown in fig. 6-8, this condition is fulfilled;

2) The product of the extreme coefficients of the polynomial equation must be less than the product of its average coefficients:

$$\begin{aligned}
 &y=0.0271x^3-2.7477x^2+83.574x-150.27; \\
 &\quad 0.0271 \cdot 150.27 > 2.7477 \cdot 83.574; \\
 &y = 0.0313x^3 + 0.016x^2 + 14.652x + 3.3057; \\
 &\quad 0.0313 \cdot 3.3057 > 0.016 \cdot 14.652; \\
 &y = 0.0002x^3 + 0.019x^2 + 0.8214x + 0.2004; \\
 &\quad 0.0002 \cdot 0.2004 > 0.019 \cdot 0.8214; \\
 &y = 0.00006x^3 + 0.0056x^2 + 1.3801x + 52.879; \\
 &\quad 0.00006 \cdot 52.879 > 0.0056 \cdot 1.3801.
 \end{aligned}
 \tag{13}$$

According to the graph of the change in the speed of the engine shaft, the first criterion of Vishnegradsky's resistance is not met (Fig. 4). This is due to the unstable dynamics of changes in the acceleration of the internal combustion engine. But on the graph of the change in the speed of the driving wheel and the graphs of the dependences of the speed of the engine shaft to the speed of the driving wheel, the criterion of resistance is fulfilled. As can be seen from equations 3, both conditions

of the Vishnegradskiy resistance criterion are satisfied. Therefore, it is safe to say that this CVT control system is stable and adaptive.

## 8. Conclusions

The CVT proposed by the authors has proved to be stable and adaptive. The results of experimental studies confirm the operational stability of the control system for the centrifugal variator based on a CVT. Within this system, the working link performs the function of a control system. The operating parameters of the system are at the same time its control parameters. The investigation has determined the conditions for the resistance of the ACS according to Vishnegradskiy's criteria. According to the operating principle, the proposed system is stable due to the affinity of mechanical operation and control. Therefore, the system is able to perform its functions (dynamic transformation of the engine power to the driving wheels), even under a significant perturbation influence. Hence, it has the ability to adapt to external factors, namely, a change in the frequency of the engine shaft revolution and the load on the driving wheels.

## References

- [1] O. V. Spiridonov 2008 *Methods of increasing the efficiency of the operation of automatic V-belt variators in the transmission of motorized vehicles* Abstract dis. kand. tech. sciences - Specialty 05.02.02-05 - Kovrov 26
- [2] V V Lytovchenko and M V Pidhornyy 2019 Investigation of step-by-step mechanical transmission on adaptation *Materials of the VII-th International Scientific and Practical Internet Conference Problems and Prospects for the Development of Automobile Transport* pp. 96-100
- [3] Rvsmaster.ru 2021 Sequentronic and Speedshift robotic gearbox for Mercedes-Benz. [online] Available at: <<https://rvsmaster.ru/articles-magazine/robotizirovannaja-korobka-peredach-sequentronic-i-speedshift-dlja-mercedes-benz/>>. (in Russian).
- [4] A I Leonov and A F Dubrovsky 1984 *Mechanical stepless non-friction transmissions of continuous action* (Moscow: Mechanical engineering) 192
- [5] M Podrigalo, O Koriak and V Verbytskyi 2020 Evaluation of the stability of the automotive engine under conditions of constant angular speed of the crankshaft *Collection of scientific works of the National Academy of the National Guard of Ukraine* **1 35** pp 57-68
- [6] O I Dubinets 2004 *Scientific bases of mechanics of V-belt variators as systems with control connections* Abstract dis. doctor tech. sciences 05.02.02 Mechanical Engineering Odessa 31
- [7] N M Filkin and S A Shvetsov 2008 Calculation of the V-belt variator control system (regulators) *Successes of modern natural science* **4** pp 140-142
- [8] P D Balakin and I P Zgonnik 2009 Synthesis of adaptive autovariator for mechanical drives of technological and transport machines *Dynamics of systems, mechanisms and machines, Omsk Scientific Bulletin* **1** pp 8-11
- [9] V V Lytovchenko and M V Pidhornyy 2018 Structural synthesis of the centrifugal variator belt tension synchronizer *Proceedings of the international scientific-practical internet conference "Problems and prospects of road transport development* **6** pp 117-124