

LJUBLJANA SCHOOL OF BUSINESS

MODERN APPROACHES TO KNOWLEDGE MANAGEMENT DEVELOPMENT

Collective monograph

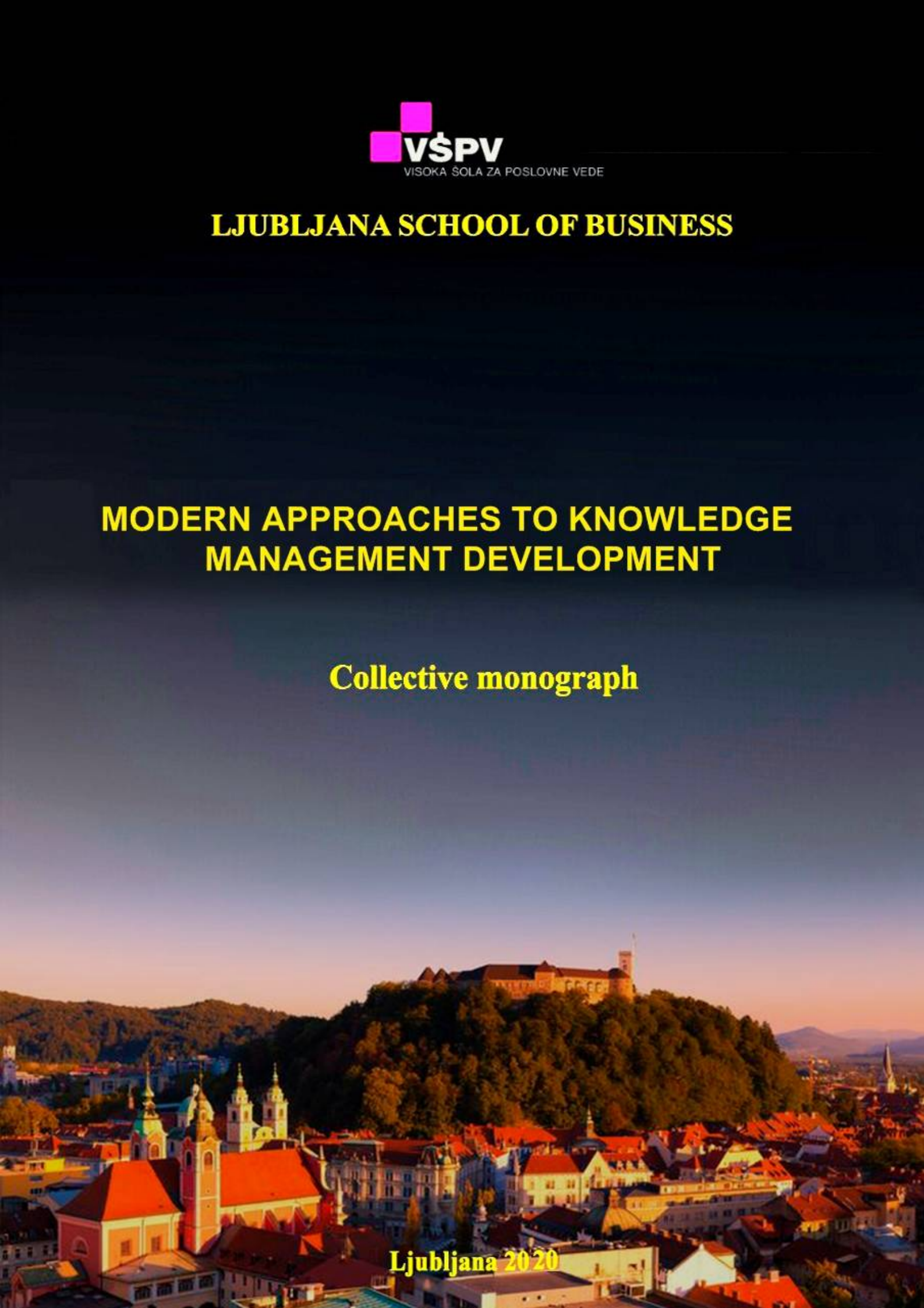

Ljubljana 2020



LJUBLJANA SCHOOL OF BUSINESS

**MODERN APPROACHES TO KNOWLEDGE
MANAGEMENT DEVELOPMENT**

Collective monograph

Ljubljana, Slovenia
2020

Editorial Board:

Darko Bele – Director of Ljubljana School of Business, Slovenia.

Lidija Weis – Doctor of Business Administration, Professor, Dean of Ljubljana School of Business, Slovenia.

Scientific Board:

Ivan Toroš – Doctor of Management, Professor, Ljubljana School of Business, Slovenia.

Nevenka Maher – Doctor of Economics, Professor, Ljubljana School of Business, Slovenia.

Julija Lapuh Bele – Doctor of Educational Sciences, Professor, Ljubljana School of Business, Slovenia.

Reviewers:

Hana Šuster Erjavec – PhD, Associate Professor, Ljubljana School of Business, Slovenia.

Julija Lapuh Bele – PhD, Assistant Professor, Ljubljana School of Business, Slovenia.

Badri Gechbaia – Doctor of Economic Sciences, Associate Professor, Batumi Shota Rustaveli State University, Georgia.

Katalogni zapis o publikaciji (CIP) pripravili v Narodni in univerzitetni knjižnici v Ljubljani

COBISS.SI-ID=18652419

ISBN 978-961-91021-8-3 (pdf)

This collective monograph offers the description of sustainable development in the condition of European integration. The authors of individual chapters have chosen such point of view for the topic which they considered as the most important and specific for their field of study using the methods of logical and semantic analysis of concepts, the method of reflection, textual reconstruction and comparative analysis. The theoretical and applied problems of sustainable development in the condition of European integration are investigated in the context of economics, education, cultural, politics and law.

Publisher: Ljubljana School of Business

Tržaška cesta 42, 1000 Ljubljana

info@vspv.si

Authors are responsible for the content and accuracy.

CONTENTS

Lidija Weis THEORETICAL APPROACHES TO QUALITY MANAGEMENT IN EDUCATION	7
Julija Lapuh Bele FINANCIAL SCAMS, FRAUDS, AND THREATS IN THE DIGITAL AGE	39
Nevenka Maher UNLOCK POTENTIAL IN PUBLIC SECTOR AND EMPOWER INNOVATION	51
Tetiana Gavrilko FINANCIAL INCLUSION AS A CONDITION OF SUCCESSFUL DEVELOPMENT OF THE UKRAINIAN SOCIETY	62
Larysa Gorodnycha, Maryna Olkhovyk, Svitlana Gergul, Tetiana Stechenko SOCIAL DEMANDS FOR PROFESSIONAL AND PSYCHOLOGICAL PROSPECTIVE EDITORS' TRAINING IN THE CONTEXT OF MODERN JOB MARKET	74
Olha Kuzmenko, Sofiia Dembitska, Serhii Radul IMPLEMENTATION OF STEM-EDUCATION ELEMENTS IN THE PROCESS OF TEACHING PROFESSIONAL SUBJECTS IN TECHNICAL INSTITUTIONS OF HIGHER EDUCATION	85
Ayta Sakun, Tatiana Kadlubovych, Daryna Chernyak ANTICIPATION OF THE LIFE PERSPECTIVE OF YOUTH IN THE CONTEXT OF THE NOTIONAL DIMENSION OF MODERNITY	96
Alona Bekh, Olena Pryiatelchuk AI-POWERED BUSINESS ACTIVITIES OF DIGITAL MEDIA COMPANIES IN TERMS OF KNOWLEDGE ECONOMY	112
Lilia Bodenchuk COMPANY HUMAN RESOURCE MANAGEMENT IN CONTEXT OF GENERATIONAL THEORY	127
Irina Liganenko COACHING TECHNOLOGY AS MODEL FOR DEVELOPMENT OF PUBLIC SERVANTS	137
Olena Sergienko, Maryna Tatar, Oleksandr Bilotserkivskyi, Valeria Baranova APPLIED ASPECTS OF PROACTIVE MODELING OF INNOVATIVE- INVESTMENT PROCESSES OF COMPLEX HIERARCHICAL SYSTEMS: ENTERPRISE – REGION – STATE	147
Alina Tkachenko PROSPECTS OF UKRAINE ON THE EUROPEAN ORGANIC FOOD PRODUCTS	162

Olga Ostapenko	
ESTIMATION OF EFFICIENCY OF ENERGY- AND RESOURCE-SAVING HEAT PUMP TECHNOLOGIES IN UKRAINE, IN THE CONCEPTS OF GREEN LOGISTICS AND SUSTAINABLE DEVELOPMENT	174
Olena Zayats	
THE TRANSFORMATION OF INSTITUTIONAL MECHANISMS OF REGIONAL TRADE-COMPETITIVE AGREEMENTS REGULATION	187
Iryna Udovychenko	
COMPETENCE APPROACH OF TEACHING LEAN-LOGISTICS IN GEOGRAPHY LESSONS AT THE PROFILE LEVEL	198
Vasily Chubar	
DIFFERENTIATION AND INDIVIDUALIZATION OF PROFILE TRAINING FOR HIGH SCHOOL STUDENTS OF TECHNOLOGY	208
Oleksiy Stupnytskyy	
NEW TECHNOLOGICAL ORDER AND CHANGE OF EDUCATIONAL PARADIGM	222
Kateryna Malinoshevska	
STRATEGIES OF MODERN INTERNATIONAL ECONOMIC RELATIONS IN THE CONDITIONS OF WORLD ECONOMIC GLOBALIZATION	233
Viktoriia Levchenko, Inna Forostiuk	
CULTURAL AWARENESS OF ACADEMIC AND TEACHING STAFF IN THE LIFELONG LEARNING CONTEXT	266
Ihor Proshukalo	
CUSTOMER ORIENTATION OF THE PERSONNEL AS PHILOSOPHY OF ORGANIZATIONAL CULTURE FOR THE MODERN SERVICE ORGANIZATION	243
Daria Kononova, Olena Kobus, Petro Zaiets	
GENRE DIVERSITY OF K-POP CULTURE AND ITS IMPACT ON THE MODERN WORLD (BASED ON K-POP CLIPPING)	262
Halyna Mamus, Halyna Havryshchak, Iryna Lutsyk, Roman Monko	
PREPARATION OF FUTURE TEACHERS OF TECHNOLOGY FOR THE ORGANIZATION OF PUPILS' EDUCATIONAL ACTIVITIES IN THE MODERN INFORMATION AND EDUCATIONAL CONDITIONS	289
Hanna Chechelnytska, Viktoria Antonova	
MODERN UKRAINIAN YOUTH AND HISTORICO-AXIOLOGICAL FEATURES OF SOCIAL COMMUNICATION	299
Nelia Dehtiarova, Yulia Rudenko, Sergii Petrenko	
PEDAGOGICAL DESIGN IN E-LEARNING	313

Oxana Nefedchenko RESERCH OF THE MAIN COMPONENTS OF HEURISTIC EDUCATION IN UKRAINIAN PEDAGOGY	324
Nataliia Prykaziuk, Vasyl Erastov, Oksana Lobova PERSPECTIVES OF IMAGE RECOGNITION UTILIZATION IN INSURANCE	335
Iryna Soroka SPECIFICS OF TEACHING CONFLICT MANAGEMENT COURSE AT UNIVERSITY	344
Lenina Zadorozhna- Knyagnitska MANAGEMENT DEONTOLOGY AS A NEW AREA OF SCIENTIFIC KNOWLEDGE IN EDUCATION MANAGEMENT	356
Nadiia Kirzha FORMATION OF STUDENTS' COMMUNICATIVE COMPETENCE IN INFORMATION EDUCATIONAL ENVIRONMENT OF MEDICAL COLLEGE	368
Iryna Kozub, Mykola Bodnaruk LABOUR CONTRACT AS A MEANS OF PROTECTION OF LABOUR RIGHTS OF PERSONS WITH DISABILITIES	378
Nataliia Kraus, Kateryna Kraus, Valerii Osetskyi PLACE AND ROLE OF MARKETING IN INNOVATIVE ENTREPRENEURIAL UNIVERSITY	388
Liudmyla Voronovska, Oksana Ivashchenko, Yuliia Nenko PEDAGOGICAL FACILITATIVE INTERACTION IN THE PROCESS OF PROFESSIONAL TRAINING OF PSYCHOLOGISTS	400
Tetiana Yu. Dudka, Mykola Ye. Chumak, Iryna S. Markus PEDAGOGICAL FUNDAMENTALS OF THE RESEARCH OF KNOWLEDGE MANAGEMENT DEVELOPMENT IN HIGHER EDUCATION	412
Olena Veligura THE CONTINUITY IN THE FORMING SINGING SKILLS OF JUNIOR PUPILS	424
Lyudmila Sidorchuk, Tetiana Sivashenko IMPLEMENTATION OF NEW INNOVATIVE TECHNOLOGIES IN THE EDUCATIONAL PROCESS OF UKRAINE AND THEIR INVESTMENT	434
Lesia Syniavska, Hanna Truba THE LITERARIFICATION. THE MAIN FEATURES AND CHARACTERISTICS OF THE PHENOMENON	448
Oksana Beryslavska, Viktor Dobrovolskyi, Igor Tolok DISTANCE LEARNING TECHNOLOGIES FOR TRAINING SPECIALISTS IN THE CIVIL-MILITARY RELATIONS PROGRAM: OPPORTUNITIES AND PROSPECTS	458
Olha Zavialova, Oleksandr Stakhevych, Halyna Stakhevych COMPONENT CONSTITUENTS OF FORMING A CULTURE OF ENSEMBLE PERFORMANCE IN THE FUTURE SPECIALISTS OF MUSICAL ART	469

Olha Kuchma, Liudmyla Sinyova, Galyna Kuzmenko OCCUPATIONAL SAFETY AND HEALTH AND PREVENTIVE MEASURES IN COAL INDUSTRY	479
Konstantin Bogomaz, Yuriy Kravtsov THE PURPOSE OF PHILOSOPHICAL CULTURE IN FORMATION OF THE FUTURE ENGINEER'S THINKING	489
Vasil Telelim, Yuriy Prykhodko, Vadim Shemchuk CONCEPTUAL FOUNDATIONS FOR THE DEVELOPMENT OF MILITARY EDUCATIONAL SYSTEMS OF LEADING NATO MEMBER COUNTRIES	499
Viktoriiia Stoika THE ISLAMIC BANKING: FEATURES, GLOBAL TRENDS AND OPPORTUNITIES FOR UKRAINE	510
Tatyana Pakhomova, Anastasiia Rokotianska PUBLIC-PRIVATE PARTNERSHIP RISK MANAGEMENT IN UKRAINE	522
Nina Fedorova, Vasily Madzigon, Svitlana Merkulova STUDIES OF INNOVATIVE PEDAGOGICAL ACTIVITY OF A TEACHER	532

Lidija Weis

*Doctor of Business Administration, Professor,
Dean of Ljubljana School of Business, Ljubljana, Slovenia
orcid.org/0000-0001-5193-5103*

THEORETICAL APPROACHES TO QUALITY MANAGEMENT IN EDUCATION

***Abstract.** Concerns about the quality of education have lately increased for those who are involved in it both directly and indirectly, primarily including those who use its services. Access to education and high-quality education are to be regarded as mutually dependent and inextricable needs and rights. Such access is primarily achieved by developing creativity and civic and democratic values, as well as through the knowledge, abilities, and skills needed for everyday and professional life. The main objective of this paper is to critically appraise various service quality models that could be easily applied in education, and to identify issues for future research based on a critical analysis of extant literature. Ensuring excellent quality of service is a generally accepted key requirement of business operations. High-quality services are not just a matter of a company's range of products and services, but also their competitive weapon. However, the quality of services, especially in the services sector, which, by all its attributes, includes education, remains a complex concept with no clear consensus on the factors that affect the provision of quality services. On the other hand, many companies use customer satisfaction as a measure of their performance. Consumer satisfaction is thus becoming a key business objective of many companies, as this is what gives them long-term viability and a competitive advantage. For this reason, quality of services and customer satisfaction constitute a major challenge in education, and they require the implementation of marketing strategies and the introduction of marketing practices and concepts from other sectors in their business.*

Introduction

Over the last few decades, service quality has become an important field, garnering considerable attention by professionals, managers, and researchers due to its large impact on business performance, lower business costs, customer satisfaction, customer loyalty, and profitability (Leonard & Sasser, 1982; Cronin & Taylor, 1992; Hallowell, 1996; Chang & Chen, 1998; Silvestro & Cross, 2000; Sureschander et al., 2002). There has been continued research on the definition, modelling, measurement, data collection procedure, data analysis, issues of service quality, etc., all leading to the development of sound research bases. Service quality assurance is an essential strategy for organizations' success and survival in today's competitive environment (Parasuraman et al., 1985; Reichheld & Sasser, 1990; Zeithaml et al., 1990; Grönroos, 1990). In the past, organizations felt that they could determine consumers' wants and needs. Consumers today, however, are much more educated and demanding, so they judge quality more sharply and are willing to pay for it. In the mid-1980s, quality was a key competitive advantage. In the last decade, it has transformed from a strategic advantage into a competitive necessity (Kaplan & Norton, 2000).

Review of quality models

Various authors understand the concept of service quality differently. Service quality, according to Fitzsimmons and Fitzsimmons (1998), is a function of the relationship between a consumer's previous expectations about the service and their perception of the experience during and after service provision. Zeithaml et al. (1990) define service quality as the extent of the discrepancy between consumer desires or expectations and their perception. Cristopher et al. (1993) define it as an organization's ability to meet or even exceed consumer expectations. Some authors

define quality as excellence (Tuchman in Cviki, 2000), value (Abbot in Kodrin, 2007), while others define it as acting in accordance with specifications (Levitt in Kodrin 2007), as precise and careful consideration of consumer demands (Deming in West-Burnham, 1997), or even as readiness for use (Juran in West-Burnham, 1997).

In various surveys of quality, some authors (Garvin, 1984; Harvey & Green, 1993; Sallis, 1993; Dahlggaard, 1998; Kump, 1996) distinguish between absolute and relative quality, calling absolute quality an ideal that cannot be compromised. Relative quality, conversely, is evaluated by determining how well a product or service meets the specification that is designed for it.

Service quality is a multidimensional construct (Cronin & Taylor, 1992; Grönroos, 1990; Parasuraman et al., 1985) and there is no general agreement on the nature of its dimensions (Brady & Cronin, 2001). A review of studies on service quality explicitly shows that there exist both American and European perspectives. The American perspective focuses on the attributes of functional service quality, while the European perspective argues that service quality contains two additional components, namely technical quality and organizational reputation (Kang & James, 2004). Early research on service quality concentrates on SERVQUAL and, consequently, on the dimension of functional quality.

The American Association for Quality Control (Kotler, 1998, p. 56) defines quality as the set of characteristics and characteristics of a product or service that affect its ability to meet expressed needs. Grönroos (in Lovelock, 1996, p. 464) believes that the quality of service is the result of an evaluation process in which consumers compare their perception of services and the outcome of services with their expectations. Unlike definitions relating to needs (Kotler) and expectations (Grönroos), however, Lovelock (1992, p. 239) describes quality as the intended desired level of excellence and the control of variability in achieving that excellence in meeting consumer demands. Zeithamlova and Parasuraman (2004), meanwhile, define service quality as the difference between the expectations of service users and their view of the service's actual provision.

In contrast to product quality, service quality is evaluated both after provision and after the results of the service are evaluated. Quality is a philosophical concept. Definitions of quality differ and to some extent reflect the various perspectives of individuals and society. A democratic society must have enough room for people of different views; there is no single definition of quality that is right at the expense of everyone else. And, indeed, we can catch ourselves jumping from one perspective to another without sensing any conflict. We can conclude that everyone may have a different understanding of quality in the field of education, but not necessarily that anyone is wrong or right.

Quality is a concept that has different meanings for different participants; however, since it is the consumers who make the most decisions about an organization's fate, their perception of quality must be given priority. From a marketing point of view, it makes sense for a service organization to consider how consumers perceive its service of its values, investments, and creative abilities. Services should also be objects of perception, and their level of quality is influenced by the values, emotions, and expectations, and the ability to perceive both providers and consumers. Therefore, it is not enough for services to meet norms and regulations, but they must maintain and enhance consumer satisfaction, thus allowing for mutual positive recognition (Snoj, 2000).

To summarize the definitions so far, quality is what consumers perceive and assessments thereof should be based on the consumer's needs and wants. A definition of service quality must therefore consist of (Snoj, 1998):

- objective (rational) quality and
- subjective (perceived) quality.

Therefore, a distinction must be made between quality that meets expectations and quality that meets specifications (standard quality). Objective quality can be measured in a laboratory or otherwise accurately according to a specific standard. Standard quality is objective. It is defined by the service organization with procedures and service providers (Potočnik, 2000). Subjective quality cannot be measured accurately. It is determined by the subjective, psychological perceptions of consumers and service providers, who evaluate quality under the influence of values, expectations, emotions, and perceptive abilities. Expectant quality is defined by the consumer when the service has already been provided. This quality is subjective (Potočnik, 2000). In addition to the division into subjective and objective quality, we also know the division according to whether the service is easier or harder to evaluate, distinguishing three types of quality (Potočnik, 2000):

- quality sought,
- experiential quality, and
- the quality of trust.

The quality sought covers features that the consumer can determine before purchasing or consuming the service (colour, shape, price, smell, etc.). It is typical for products and physical components of services. The experiential quality covers the characteristics of the processes or the results of those processes (kindness of staff, etc.). Quality is perceived by consumers during consumption or after purchasing a service or product. Confidence quality includes features that are difficult to evaluate even after purchase or during consumption (computer repair, surgery). It dominates the services provided by professionals. Services are primarily concerned with experiential and trusting qualities.

The service quality construct has been conceptualized in service marketing literature as perceived service quality, defined as the consumer's judgment of an organization's overall excellence or exceptionality (Zeithaml, in Kang & James, 2004). According to Grönroos (Grönroos, 2000), consumers evaluate service quality based on technical and functional quality. Outcome quality is the result of the relationship between the provider and the consumer in dealing with the service. For consumers and their quality assessment, what they get when interacting with an organization is very important. Technical quality is an assessment of a service's content, referring to the result of the performance of the service – what the consumer received through the performance of the service. It indicates what is left to the consumer when the service delivery process and interaction between the consumer and the provider are complete. Consumers generally evaluate technical quality objectively. Functional quality (process quality) involves the psychological interaction between the consumer and the contractor. It is an assessment of the modes or procedures for the provision of the service, that is, the way the service was offered and performed. Perception is very subjective. Grönroos also emphasizes the importance of reputation, since the image of the service organization (Kang & James, 2004) is also influenced by the consumer's perception of the quality of services, a similar idea previously suggested by Lehtinen & Lehtinen (1982). Consumers often have continuous contact with the same service organization, so they bring to each service episode their experience and perceptions of the service organization. The service organization image concept is therefore presented as an additional important component of the perceived service quality model.

Quality of service can be the basis for an organization's competitive advantage. Technical advantages are difficult to obtain today because organizations can achieve similar levels of technical quality very quickly. Excellent technical quality can be offset by poor functional quality. An organization can achieve a competitive advantage by improving its functional quality. This does not mean that technical quality is not important, as it is usually a prerequisite for good service. When technical quality is poor, consumers perceive service quality as poor. If only the technical quality is good, it does not mean that consumers perceive the quality of service as good; functional quality must also be good (Grönroos, 2000). Quality is therefore, as many social science concepts, difficult to define. We can say that the definition of quality is almost as high as that of the authors. Garvin (in Lagrosen et al., 2004) classifies quality definitions into five major groups:

- Transcendent definitions. These definitions are subjective and personal. They are eternal but go beyond measurement and logical description. They are related to concepts such as beauty and love.
- Product-based definitions. In these definitions, quality is perceived as a measurable variable. The basis for measurement is the objective characteristics of the product.
- Consumer-based definitions. According to these definitions, quality is a means of achieving consumer satisfaction and is therefore partly subjective.
- Production-based definitions. In these definitions, quality means following requirements and specifications.
- Value based definitions. These definitions look at quality in relation to cost. Quality is seen as value that exceeds cost.

Consumer-based definitions seem to prevail over time, but all definitions must be integrated. Ideally, quality management is a means or a way to bridge the gap between external quality management as perceived by consumers and internal quality management that focuses on compliance (Gummesson in Lagrosen et al., 2004). In quality of services, the emphasis lies on customer satisfaction. In service activities, however, the consumer often must be actively involved in the provision of the service, and such participation should be properly encouraged and managed. Therefore, it is very important to find or know the factors that cause consumer satisfaction. The term quality dimension is often used in this context. Instead of trying to find a good set of definitions, it makes sense to focus on the dimensions that create quality and reach some social consensus on them. Scientists have tried to define the quality dimensions in terms of services. The best-known set of dimensions is proposed by Parasuraman et al. (1985) and Zeithaml et al. (1990). Table 1 compares service quality dimensions across authors.

Table 1. Comparison of service quality dimensions among different authors

Garvin (1991)	Berry, Parasuraman in Zeithaml (1985)	Zeithaml, Parasuraman in Berry (1990)	Grönroos (2000)
Operation	Tangible	Tangible	Technical relevance
Features	Reliability	Reliability	Functionality
Reliability	Responsiveness	Responsiveness	Environment
Compliance	Decency	Confidence	Price
Durability	Courtesy		
Competence	Credibility		
Aesthetics	Security		
Perceived quality	Accessibility	Consumer orientation	
	Communicative		
	Understanding consumers		

Source: D. Garvin, 1991; L. L. Berry et al., 1985; V. Zeithaml et al., 1990; Gronroos, 2000.

Dimensions as developed by Garvin (1991), unlike the others presented, are used mainly to measure product quality and, to a lesser extent, service quality. The dimensions presented have important value for conceptual understanding of quality, but it is still important that we study quality in each specific situation (Lagrosen, 2004). As a result, any additional dimension developed for any situation is a valuable complement to the overall dimensions. Care for quality is one of management's important strategic tasks in an organization. Those providing high-quality service management must constantly look for answers to the question of how to make best use of existing resources in the organization. Quality management accordingly requires the involvement of all functions within the organization, although there is a risk that each function unit in the organization is only seeking to optimize its own processes and effects at the disadvantage of optimizing the performance of the organization. In order to reduce this risk, the organization must define the quality criteria for the organization (Conti, 1989). It is reasonable to define these criteria for two types of fundamental processes and their effects: • for processes that are directly directed from the organization to the environment (to consumers), or are components of services that are objects of exchange; for processes that create useful value within the organization.

Good quality management must consider (Feigenbaum, 1989):

- that quality is a concept inherent in every organization;
- that quality refers to both outcomes and ways of operating within the organization;
- that the pursuit of quality is successful only to the extent that it offers a genuine opportunity for participation by all members of the organization;
- the need to implement quality management in terms of both external and internal customers;
- that quality care requires new ways of thinking and acting; and
- that quality management can be as effective and direct as sales, production, purchasing, and other business functions in any organization.

Quality management is a process that encompasses the activities of consciously defining, achieving, and controlling the quality objectives throughout the service organization. The basic levels of quality management according to Snoj (1992) are planning, quality control, and improvement. When designing the quality of services, the most important thing is to identify consumers and their needs, and thereupon to define the concept of services. In quality control, we must determine whether we are meeting the targets or standards, whether there are deviations and why, and, of course, immediate action is needed to remedy the situation. In order to improve service quality, we must first analyse the symptoms of existing problems, identify the actual causes thereof, and develop a way to remedy those causes.

Quality is found to be largely subjective. Assessing the quality of the process is even more complex. Figure 1 illustrates how the quality experience is related to traditional marketing activities resulting from perceived quality of service. Considering, in addition to the service companies, the producers of the products and the pertaining services, it is more appropriate to speak of overall perceived quality (Grönroos, 1990). Good perceived quality is achieved when the perceived quality reaches the consumer's expectations, which is the expected quality. For unrealistic expectations, the overall perceived quality is low, although the measured perceived quality is very good in some objective ways. As can be seen from Figure 1, expected quality is a function of many factors, such as market communication, word of mouth, organization reputation, and consumer needs. Marketing communication includes advertising, direct mail, public relations, and sales campaigns that are

directly controlled by the organization. Reputation and word-of-mouth communication are the only factors that are not directly under an organization's control. The level of overall perceived quality is determined not only by the level of technical and functional quality, but by the gap between expected and actual perceived quality.

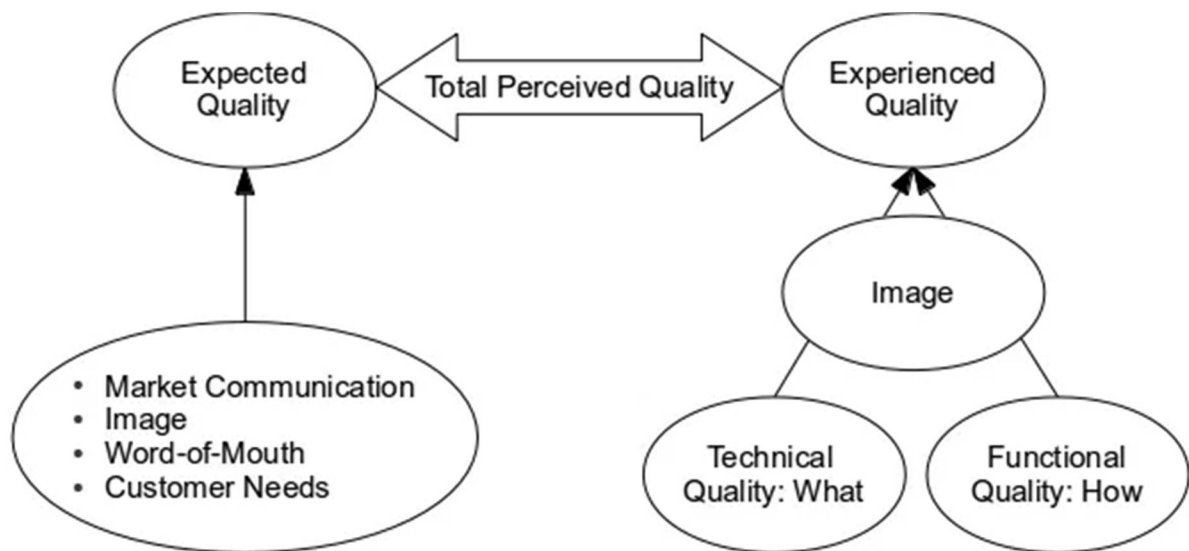

Figure 1. Total perceived quality

Source: C. Grönroos, *Service management and marketing – A consumer relationship approach*, 1990, str. 41.

Upon this recent conceptualization of service quality dimensions, a three-component model is proposed, in which the overall perception of service quality is based on the consumer's evaluation of the three dimensions of the service episode: (1) employee-customer interactions (functional or process quality), (2) the service environment, and (3) result (technical quality) (Rust & Oliver in Kang & James, 2004). While researchers support the content that the service environment influences the perceived quality of service (Bitner, 1992; Spangenberg et al., 1996), it is conceptually difficult to distinguish the idea of a service environment from the concept of functional quality proposed in the literature. Brady and Cronin (2001) incorporate three factors into the service environment, namely environmental conditions, facility design, and social factors. Brady and Cronin's (2001) definition suggests that the service environment is an element of the service delivery process. This means that it is better to include the service environment as part of the functional dimension of service quality. In addition to Grönroos's model of quality based on technical and functional quality, there are many others (Parasuraman et al., 1985; Haywood-Farmer, 1988; Brogowicz, 1990; Cronin & Taylor, 1992; Mattson, 1992; Teas, 1993; Berklay & Gupta, 1994; Dabhalkar, 1996; Sweeney et al., 1997; Frost & Kumar, 2000; Zhu, 2002; Santos, 2003). Some of them are presented below.

In the 1980s, Parasuraman, Zeithaml, and Berry developed a service quality model (Figure 2) based on gap analysis. The original model contains ten dimensions, and later studies show strong correlations between some dimensions, so the authors combine some of those dimensions with factor analysis. In the following works, the authors propose a model with five dimensions: tangibility, reliability, responsiveness, confidence, and consumer orientation (Zeithaml et al., 1992). Service quality is defined in the model as the gap or difference between the expectations of the consumer and his perception of the service. In order to improve service quality, an organization must identify the reasons for each of the five gaps and develop strategies to reduce them (Lovelock, 1996). The various gaps presented in the model are:

Gap 1 is the gap between consumer expectations and the perception of expectations by the organization's management. Often, an organization's management does not know what consumers' expectations are or do not understand them, nor does it know why consumers form their expectations. Gap reduction strategies include improving knowledge of consumer expectations through market research and complaint analysis, improving communication between contact staff and management, and reducing levels of leadership between consumers and consumers.

Gap 2 is the gap between the perception of customer expectations in leadership and the precise definition of service quality standards. Management can correctly detect the customer's preferences but does not specify performance standards. By setting clear goals and standardizing the delivery of services, this gap can be narrowed.

Gap 3 is the gap between service quality standards (specification) and the actual level of service delivery. It can result from overly complex standards, a lack of teamwork, or inadequate training if staff are overworked or are unable or unwilling to meet specifications. The gap can be reduced by properly selecting and training staff.

Gap 4 exists between the actual delivery of the service and external communication. Sometimes organizations promise too much to consumers and fail to deliver or give too little information to contact staff. When communicating with consumers, the organization should announce what the consumer receives and promise only what they can fulfil.

Gap 5 is the gap between expected and perceived service. To reduce this gap, it is necessary to narrow the remaining four gaps.

This model's advantage is that it offers a common understanding and solutions that are applicable in various fields of operation. The model helps to identify the causes of service quality problems. However, it does not pinpoint specific service quality errors that occur in specific service organizations. If the goal of an organization is to provide quality services, each organization must develop its own way of defining and maintaining the quality of its services (Lovelock, 1996).

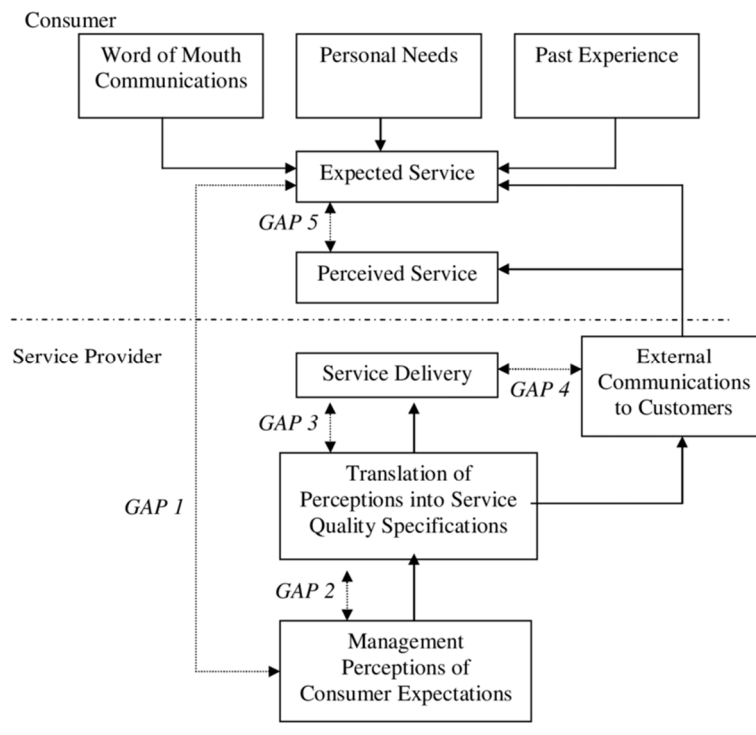

Figure 2. Gap model

Source: V. Zeithaml et al., *Delivering Quality Service: Balancing Customer Perceptions and Expectations*, 1992

Another gap model was also developed by Lovelock (2004), who, unlike other authors on service quality, believes that defining service quality, which includes expectations and perceptions, equates service quality with customer satisfaction. Lovelock expands the model of American authors by presenting seven possible gaps in his model (Figure 3), (Lovelock, 2004, p. 412):

Gap 1 is a behavioural gap – and it means that the service organization doesn't really know what the customers want. It represents the difference between the expectations of service users and the perception of those expectations by the management of the service organization.

Gap 2 is a gap in standards and occurs when an organization is aware of customer expectations but does not take that into account when setting service standards. It represents the gap between the perception of the organization and the precise definition of the quality of service.

Gap 3 is a performance gap and occurs when service providers fail to comply with performance specifications.

Gap 4 is a gap in internal communication and arises from different views on the services of advertisers and the organization. Advertisers promise a service that the organization is not even capable of delivering.

Gap 5 is a discrepancy in perceptions and represents the difference between the service performed and perceived, as the quality of service consumers are not able to accurately evaluate.

Gap 6 is the gap in the interpretation of an organisation's communication messages and arises as the difference between what the organization wants to convey and how consumers perceive the message.

Gap 7 is a service gap and arises as a gap between the expected and perceived service.

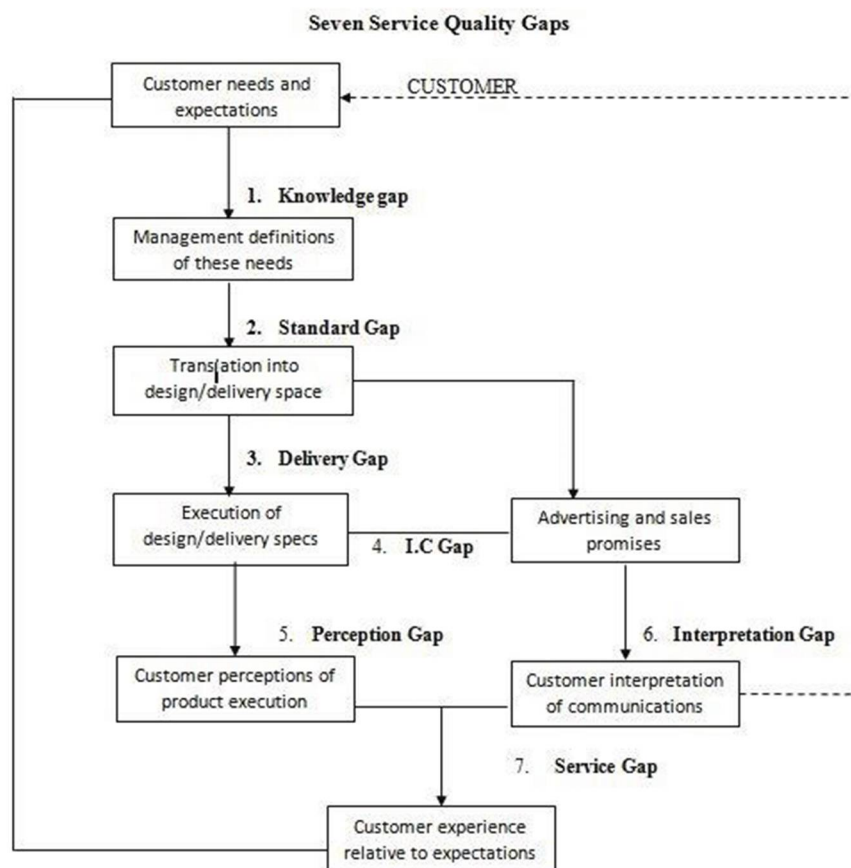

Figure 3: Lovelock gap model

Source: C. H. Lovelock, *Services Marketing*, 2004, str. 412.

Lovelock (2004) believes that any of the seven gaps can impair an organization's relationship with consumers, adding that experiencing each service is the sum of good and bad experiences. By reducing the gap between consumer expectations and perceptions in each confrontation with a service, the service organization enhances its goodwill.

Lovelock in this model assumes that the determinants of quality of service are also determinants of customer satisfaction with the service. Taking into account the definition of satisfaction of some other authors (e.g., Cronin & Taylor, 1992; Zeithaml & Bitner, 2003), which is otherwise discussed in the following chapters and which states that the concept of satisfaction is broader and that the perceived quality of service is only one of the components of consumer satisfaction, the model is unsuitable for determining the quality of educational services. Consumer satisfaction is also greatly influenced by the price of educational services, situational factors, and personal factors (Kodrin, 2007).

The service quality model developed by Haywood-Farmer (1988) states that service organizations have "high quality" if they consistently meet consumer preferences and expectations. Accordingly, separating attributes into different groups is the first step to developing a service quality model. Generally, services have three basic attributes: physical capabilities and processes, human behaviour, and professional judgment. Each attribute consists of several factors. In this model, each set of attributes represents an apex of the triangle, as presented in Figure 4. Excessive concentration on either of these elements at the expense of neglecting others can lead to disaster (Seth & Deshmukh, 2005). In the model, the author tries to establish a "map" for different types of services according to the level of contacts and interactions, the level of work intensity and the level of custom-made products. For example, services that are characterized by work intensity and have little contact with consumers are closer to the model's physical capacity and processes. In this case, the model suggests that attention should be paid to the reliability of equipment that the consumer can easily use.

The quality model is certainly also interesting for educational services, especially since today almost all education is supported by e-technology and all three attributes are also important for traditional forms of education, where there is a lot of contact in the form of interaction between consumers and the organization.

Brogowicz et al. (1990) developed a synthesized model of service quality, believing that a gap in service quality can exist even when consumers are not yet experienced with a service but are familiar with it due to word-of-mouth communication, advertising, or other communication media. The potential consumer's perception of service quality as well as actual experience of service quality should accordingly be included. The model attempts to link traditional managerial frameworks with service design, operations, and marketing activities. The model's proposal is to learn about the dimensions associated with the quality of service in the traditional managerial framework of design, implementation, and control. The synthesized model of service quality considers three factors, namely the organization's reputation, external influences, and traditional marketing activities, as influencing expectations regarding technical and functional quality (Seth, et al., 2005).

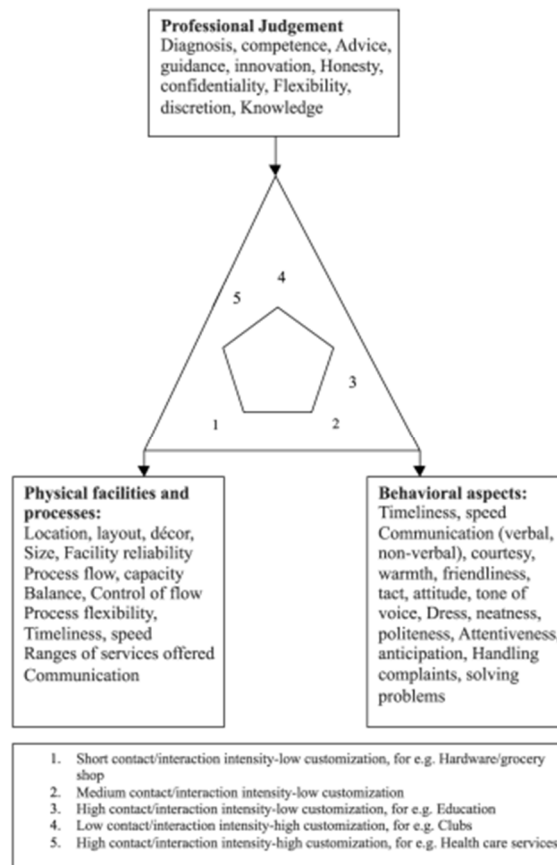

Figure 4: Attribute service quality model

Source: J. Haywood-Farmer in N. Seth and S. G. Deshmukh, 2005, str. 919.

The model of perceived service quality and satisfaction proposed by Spreng and Mackoy (1996) attempts to strengthen understanding of the constructs of perceived service quality and satisfaction. This model highlights the effects of expectations, perceived performance desires, desired congruency, and expectation disconfirmation on overall service quality and customer satisfaction. These are measured through a set of ten attributes of advising (convenience in making appointment, friendliness of the staff, advisor listened to my questions, the advisor provided accurate information, the knowledge of the advisor, the advise was consistent, advisor helped in long-range planning, the advisor helped in choosing the right courses for career, advisor was interested in personal life, and the offices were professional).

Cronin and Taylor (1992) explore the conceptualization and measurement of service quality and its links to customer satisfaction and purchasing intent. They compare perceived quality with expectations, concluding that perceived quality is a better predictor of service quality. The authors believe that service quality is directly influenced only by the perception of the service delivery.

Knowing the importance of service quality leads to the systematic and intensive development of different concepts and models. The quality of service literature is being developed gradually, with authors constantly upgrading models and learning from the findings and views of their predecessors. Grönroos (1984) notes that word-of-mouth communication has a significantly greater impact on potential consumers than traditional marketing activities, thus shedding light on the need to explore the quality of services from a consumer perspective. Later, Parasuraman et al. (1985) position the service quality model as a gap between consumers and marketers at different levels, where word-of-mouth communication significantly contributes to service expectations.

Later, the same authors revise the model and develop the SERVQUAL measurement instrument, which underlies Kumar's (2000) model of internal service quality. Elements of both models, namely Grönroos's and Parasuraman's, Brogowicz (1990), combine and develop a synthesized model of service quality. Cronin and Taylor (1992) find that service quality is a precursor to customer satisfaction, which is essential for purchase purposes. This leads to the development of a model of perceived service quality and satisfaction (Spreng & Mackoy in Seth & Deshmukh, 2005). Cronin and Taylor (1992) point out that consumers do not always buy the highest-quality services, *inter alia* due to their assessment of the value of services. This realization illuminates the importance of value, which motivates researchers to include value in service quality models. Mattsson (1992) develops a service quality model in which it also incorporates a value construct. In a liberalized economy, it is difficult to remain competitive, so service providers are increasingly offering information technology services to their customers as an option. Service providers use information technology to reduce costs and create added value for their customers. The growing importance of information technology motivates researchers to better understand how consumers evaluate IT-based services and how their assessment affects their perception of the overall quality of service provider's services and their own satisfaction (Seth et al., 2005). This leads to the integrated development of many models of service quality, including those of authors Berkley and Gupta (1994) and Santos (2003).

The review shows that there is no universally accepted conceptual definition and model of service quality, nor a generally accepted operational definition of how to measure service quality. Nevertheless, most models and definitions support the view of service quality assessments by comparing quality expectations with perceived quality of service after experience (Seth et al., 2005), constituting a rational-technical aspect of quality.

Even regarding theoretical foundations, not even large-scale theories of quality can be found in the scientific literature. For this reason, we can understand it from key definitions and quality models. For the purposes of the dissertation, the theory is understood primarily as the logic behind or explanation of the meaning and connections between the key elements of services. Thus, it seeks to explain the space between expectations and perceived performance, and between individual components (dimensions of quality in terms of which dimension is more important and why). It further aims to show how expectations are formed and how comparisons between expectations and perceived performance are made. This is perhaps the most obvious reason why we need a theory – for example, the question is whether our expectations are an objective reference point and do not change (and judging perceived performance or quality), or whether expectations influence only detected operation or quality assessment (and are not an objective, stable reference point). Several studies considered indicate that expectations have a positive impact on perceived quality – the more positive our expectations, the higher our level of perceived quality. Another topical aspect of theoretical underpinnings can be found in the review of the historical concept of quality, which is initially focused on products and interprets quality as a proportion of defective products, but then other aspects such as consumer understanding of quality come to the fore over time.

However, the quality of most services and the level of customer satisfaction depend not only on how the service provider renders the service, but also on how the consumer plays its role in the service, such as in the educational process. Consumer behaviour is also affected by the quality of services. Expectations and responses in turn influence the behaviour of employees and other consumers, and vice versa. Quality assurance is therefore an ongoing process that requires a

commitment to the quality of all employees in the organization. High-quality services are those that, with their excellence, satisfy consumer demands and at the same time satisfy providers or contractors. Consumers in educational services (for example, participants in adult education) can openly express their satisfaction in the educational process itself, for example through lectures. However, the performers receive feedback on how lectures are conducted from the visitors based on the useful knowledge gained. For example, during lectures, participants with active participation show that they are satisfied by asking questions, that they want to learn more by regularly attending lectures, all of which is useful feedback for the lecturer and a guideline for future work.

As stated earlier, in the service industry there are frequent employee-customer interactions. Certain services by their nature lead to interactions that are both time-consuming and impactful, so the quality of internal processes and employees must be considered in order to achieve the external quality of service as assessed by consumers.

Process quality management in adult education

Comprehensive quality management is, from a service organization perspective, a process that encompasses the activities of conscious decision making, achievement, and control of quality goals throughout the organization. Not only does it relate to activities directly tied to the goals of offering and delivering services, but also to activities related to the goals of procurement, staffing, remuneration, and other areas of the organization, although they may at first seem to be not directly related to the level of service provision and delivery (Snoj 2000, p. 166).

Modern organizations are successful primarily because of their ability to provide high-quality services anytime and anywhere, to meet or even exceed target consumers' expectations. Achieving this goal requires dedication, motivation, and commitment. In addition, performance criteria must be modified several times (Vandermerwe & Lovelock in Faganel, 2010).

The changes that have taken place in the education sector over the last few years are aimed at introducing responsibility, efficiency, and competition into the sector. Educational institutions can use quality to create a competitive advantage to meet these changes (Joseph & Joseph, 1998). Service quality is increasingly becoming a key factor in differentiating services and building competitive advantages (Ennew et al., 1993). Equally strong competition in education in many countries demonstrates the need to assess consumers' perceived quality of service (Ford et al., 1999).

The quest for flourishing quality in adult education is not new. The dissemination of the culture of quality must be seen in developing new knowledge, promoting and assisting adult education providers in achieving a higher level of quality, and in introducing changes that open the door to more demanding standards in this field. Quality care must be planned, as part of both the management strategy and the efforts of the employees. It should be based on responsibilities towards participants in education, to companies, and other service users, funders, the local environment, and the profession itself.

The most important prerequisite for quality assurance is knowledge of consumer expectations. Simply put, offering excellent services as expected by the consumer requires organizations to know the consumer's expectations (Zeithaml et al., 1992). If organizations do not know what their customers want, then how can they design programs that match consumer expectations, a prerequisite for quality service (Joseph et al., 2005). However, in the context of education, it is necessary to identify "consumers". Pečar (2007) distinguishes four types of "consumers":

- primary stakeholders – those who receive services directly (learners);
- secondary stakeholders – administrators, sponsors, employers, parents of young people, all with a direct stake in the education of an individual;
- tertiary stakeholders – those who have less direct, but still significant stake in education; these are future employers, management and society as a whole;
- internal stakeholders – these are employees of the educational organization and those who have a significant stake in the success of the organization.

The needs and views of various consumer groups, whether internal or external, are not always covered. Potential and actual conflicts of interest always exist. One of the best methods of dealing with different interests is recognizing their existence and finding the key issues that unite them.

All stakeholders must be treated fairly, and their views must be heard, as quality and equity are closely linked. The primary mission of an educational institution is to meet consumers' needs and requirements. It is important to recognize that growth and long-term survival depend on their adaptation of services to learners' needs of learners. Without consumers, no educational organization exists. Everyone who works in an educational organization is both a provider of some services and a consumer of others. Each staff member gives and receives services at the same time. Internal relationships with consumers are vital if the organization is to function efficiently and effectively. The best way to develop an internal customer focus is to help individual staff members identify the people they provide services to. It is important to find out what they want and have a good idea of the standards they require. Educational organizations must be aware that quality is what the consumer says it is, not what the organization claims it to be (Pečar, 2007).

On the role of service quality in education, Shank et al. (1995) point out that education contains all the characteristics of service activities. Educational services are intangible, heterogeneous, inseparable from the person at runtime, variable and, finally, the consumer (student) participates in the implementation process. Educational institutions find themselves in an environment that must be geared towards understanding the role and importance of quality of service; this environment is extremely competitive. In this case, a highly competitive environment means that education participants become more biased and demanding in their choice of educational organization. For this reason, it is important for educational organizations to understand potential participants' desires and know their expectations. Therefore, educational organizations must determine participants' expectations regarding the quality of educational services (Joseph et al., 2005).

When thinking about what quality means in adult education and how to define it, we find that the concept of quality is defined very differently, as is its application to different fields. Many authors who seek to define quality agree that it is much easier to identify than to define. There is a need to give a market-oriented perspective of the quality of services and summarize from all definitions that quality is what consumers perceive, and that it must be based on the consumer's needs and wants. In order to define quality from a pedagogical point of view, or what constitutes quality in education, it is also important to clarify or define quality in a non-marketable, more general way.

The field of educational services was influenced by different quality concepts. However, the very concept of quality, as experienced by users of educational services, is a rather neglected area in theoretical study in the field of education (Kodrin, 2007).

Ferjan (1999) considers that quality in the educational activity is very difficult to define precisely, since different expectations and interests of different publics of educational organizations and different educational organizations (public and private educational organizations, associations educating their members, etc.) are reasons for different, sometimes even conflicting definitions.

Sallis (2001) emphasizes that the quality of education is a dynamic construct in which precise definitions do not help us, since quality in education has many meanings. Cagranova (in Kodrin, 2007) believes that a high-quality education is one that meets the needs of its participants, that is, education that is useful and meaningful to them. Milekšič (1999) adds that a high-quality educational organization is one that, through its products and services, meets the needs of those consumers for whom it is competent. Greenwood and Hount (1994) find that quality in education equals consumer satisfaction. Education is expected to be responsive and responsive to consumer expectations and needs and to change. However, in their view, there can be no "endless" response to the needs and expectations of education as a system, since in absolute terms this response is limited by legislation.

Authors dealing with the quality of educational services use three interrelated quality criteria (Barnes, 1994): the degree to which the educational service meets consumer needs, differences in the amount of some desired tangible elements of the educational service, and compliance with educational standards.

Bregar et al. (2010) consider that quality in modern education is a main strategic orientation. The quality of educational services is a generic concept, one whose content depends on the socio-political and cultural characteristics, and institutional frameworks in which the education takes place, as well as on the goals, levels, and forms of education. Regardless of the diversity of conceptions of the quality of educational services, views on quality can be divided into two groups (Bregar et al., 2010):

- quality as a set of characteristics of services that meet the needs of the participants in the education (thus expressed by the level of satisfaction with the characteristics of the educational service);
- quality as compliance with standards (so we are talking about matching the characteristics of educational services with the requirements given in the standards or specifications).

The first aspect is at the heart of non-formal education. Quality is monitored through various methods of assessing the satisfaction of education participants using a survey methodology for measuring attitudes, and the quality of services is also taken care of by various agencies and consumer protection associations.

The second aspect relates to accreditation and quality assurance processes and is mainly established in formal education. Accreditation is a process designed to ensure that higher education institutions and other organizations meet and maintain minimum quality standards for academic, administrative, and other education-related services.

The fact is that quality cannot be defined uniquely and that it is difficult to absolutize, wherefore it is difficult to define quality indicators that are intended to help assess quality. It is difficult to answer the question: How to set one-sided quality indicators (based on which we will judge quality) in cases where quality can mean different things to us in the same case (and at the same moment)? (Možina, 2003).

Also, Cheng and Tam (1997) argue that quality in education is a multidimensional construct and cannot be easily assessed by a single indicator. There is no consensus among many definitions

of quality, even though they are very closely related. Different people may define quality differently, and therefore the indicators used to describe quality education may be different. Some may emphasize the quality of input into the education system, while others emphasize the quality of processes and outcomes. Although irrelevant as to whether they relate to inputs, processes, or outputs, the definition of quality in education is often linked to the appropriateness of use, to the needs of all strategic actors (policy makers, management of educational organizations, training participants, lecturers, etc.), or with the compliance of the requirements and expectations of strategic participants. By borrowing the ideas of TQM and the systems approach, Cheng and Tam (1997, p. 23) define high-quality education as the properties of a set of elements in the inputs, processes, and outcomes of educational systems that provide services that are fully relevant to internal and external strategic actors by fulfilling their explicit and implicit expectations. This definition includes important qualities of quality from management literature. If we accept this definition, then the concept of quality in education includes the characteristics of inputs, processes, outcomes and different actors in educational organizations. That is why quality in education is a multidimensional construct. In addition, the expectations of different participants in education can vary greatly, if not be outright contradictory. Because of this, it is often very difficult for educational organizations to meet the expectations and needs of all participants at the same time. It is not uncommon that the perceived quality of an educational organization is high for some, but not for others.

Based on various concepts of quality of education and ways of achieving quality in education, different people may use different indicators for quality assessment, as well as different strategies for achieving quality in education. The essence of these indicators and strategies, however, need not be that they cover all aspects of the educational organization's inputs, processes, and outputs (Cheng & Tam, 1997).

Kump (1996) considers that early in the discussions on quality, there was a polarization in the definition of the term. Some claim that they know exactly what quality is but cannot describe it. In the second group are those who are convinced that quality does not exist if it cannot be measured. In the quality treatments so far, the essentialist notion of quality has been marginalized (Možina, 2003). The nominalist conception that contains an instrumentalist interpretation of quality prevails and does not address the question of what the essence of quality is. Also, Sallis (1993) notes that in educational practice the notion of quality combines highly contradictory meanings. Quality can mean different things to different people, and we all agree that we want a high-quality education. For this reason, it is very important to have a clear idea of the different meanings of the notion of quality, otherwise we face the danger that this concept remains only a concept of high moral value, but of little practical value.

Crosby (1979) defines quality as "compliance with demand", while Juran and Gryna (1980) define quality as "suitability for use". Deming (1986) defines quality as "a predictable degree of unity and reliability at low cost and market-appropriate". In their original work, Harvey and Green (1993) define quality as a relative concept, since quality has many meanings. The authors therefore distinguish the concept of "quality as an absolute concept" from the concept of "quality as a relative concept". As absolute, quality is similar in nature to some ideal that cannot be compromised. According to the absolute definition of quality, these are things that have the highest standards, ones that cannot be exceeded. In this case, quality is used to attribute the status and positional advantages and possessions of "quality things", which separates their owners from those who cannot afford

them. In this case, the synonym for quality is "superior quality". In contrast to the absolute conception of quality, the term quality can also be defined in relative terms. In this case, quality is not understood as an attribute of a product or service, but rather something attributed to that product or service. In this case, quality is judged by determining how well a product or service has met the specification (description) that has been set for it. In this case, quality is not an end, but a means by which to judge whether the finished product meets the set standards (Možina, 2003). A product or educational service is of good quality if it meets the simple but essential standards for the activity in which it takes place or for the goals we want to achieve. An educational organization must therefore do what it says it does and what consumers (students) expect it to do (Sallis, 1993). Here, however, the dilemma is whether educational services can be standardized by the ISO system. The new ISO standard 29990: 2010 is the first standard aimed at improving the quality of educational services and facilitating comparisons globally. However, ISO 29990: 2010 is set up for learning services for non-formal education and training, which aims to provide a general quality model for professional practice and enforcement, as well as general guidance for learning service providers and their users regarding the design, development, and provision of non-formal education, training, and development. The standard encourages student focus and process outcomes and emphasizes the full range of choices available to provide learning services. As it addresses the competence of learning service providers, the standard assists organizations and individuals in selecting providers that meet their competency requirements and expectations and competency development. In addition, it is planned that ISO 29990: 2010 can be used to certify learning providers. The purpose of the new standard is to create an appropriate framework for the development of standards in the field of non-formal learning services. The essential elements are to ensure the quality and efficiency of education or training and to improve the transfer of knowledge, while also enhancing the transparency and comparability of the wide range of education services offered. ISO 29990: 2010 helps education service providers improve the ability to consistently deliver quality services, improve organizational efficiency, and reduce overall business costs (Rau, 2001). It is certainly worth considering, which poses a great challenge in introducing the standard into formal education in the future, although it can be seen in Slovenia that some educational organizations follow the ISO standard in quality assurance.

Quality, in its relative meaning, is a multidimensional phenomenon that is associated with different aspects of expectations. The most comprehensive classification of quality in education is proposed by Harvey and Green (1993), namely:

- Quality as exceptionalism, as something special and recognizable: an example of such quality in education is reflected in an elitist conception of the quality of study at one of the world's renowned universities. Quality in this case is not defined by the evaluation of the offer of these institutions but assumes that the specialty or inaccessibility of a first-class education is a quality.

- Quality as completeness or consistency: such a definition of quality focuses on the process and, with appropriate specifications, transforms the traditional notion of quality as excellence into something that is accessible to anyone. This is a special approach of introducing a culture of quality into an organization where everyone is responsible for the quality of the work they do. Mapping this definition to education means a shift from the final monitoring of educational effects to the ongoing, process-based monitoring of participants' progress and the achievement of educational standards for each learning phase. This is an ongoing check of the quality of all the essential processes that can affect achievement. Achievement can be influenced by various factors, such as

teacher competence, quality of planning, quality of communication processes, material resources, etc.

- Quality as fit for purpose: by this definition, a product (service) is of good quality if it meets a predefined purpose. This is a functional definition of quality that is different from traditional elitist definitions.

- Quality as value for money: by this definition, quality equals value. Quality is compared to the level of specification and is therefore directly related to cost.

- Quality as transformation: the transformative aspect of quality illuminates the aspect of quality change. This is reflected in the creation of opportunities that enable the individual to take part in the educational process and empowerment, which helps them influence their own transformation. This is much more than just responsibility to the consumer, employees, or participants in the specific education program. Assigning responsibility to employees and thus enhancing their role, aimed at unchaining their skills, is a validated strategy in the business world. It can be transferred to education by engaging participants to shape the educational process. This increases their motivation for education, while enabling us to carry out the educational process in accordance with their needs. By engaging an individual in all the essential processes of education, we enable quality changes in knowledge and its cognitive development.

The relative conception of the quality concept thus leads us to the realization that the answer to the question of what high-quality education is or what quality we want in adult education should be sought in a democratic debate that emphasizes different views and interests. This leads to the consideration of different aspects of quality and enables us to address quality concerns in adult education holistically. In any case, this is a very interesting look at the definition of quality, which could be imitated in marketing or learned from, as there is also no uniform definition for service quality, or rather different authors define it differently.

Today, education participants are much more critical than they used to be. In order to succeed, educational organizations must therefore understand what quality means from a consumer perspective and strive to improve the quality of their services in such way that the learners return to the educational establishment. As we have already noted, quality is a relative term that means different things to different people. From this we can conclude that the general public (with this we mean participants in education), the leadership of educational organizations, and employees thereof all have very different views. The basic activity of educational institutions is education, which is the process by which participants acquire knowledge and thus may obtain formal or informal knowledge. In addition to financial investments, participants must make a large contribution to their own education, as they must actively participate and learn in the process. This makes assessing the quality of an educational organization very subjective from the perspective of the individual, since participants may have a lower rating due to their own lack of input in the process of acquiring service knowledge. This insight opens an important dilemma that is certainly relevant to marketing: Is the consumer, always right? Is quality really a precursor to customer satisfaction if we always and completely satisfy the consumer? Quality in education could therefore be easily achieved if we cared for high grades. Listeners have different needs and desires. Quality in education can also be very differently understood. There is also a definition in the literature that quality is what the listener wants, not what the educational organization thinks is best for it. This is where the dilemma opens further. In adult education, some have made it clear that they only need a formal level of education to meet employer needs, that they have come only to earn a piece of paper to demonstrate

their qualification. In such a case, is the organization really of good quality if it respects and fulfils the wishes of consumers? Finally, we must be aware that there are no educational organizations without participants in education (Sallis, 1993).

Educational organizations are therefore confronted with the following questions:

- What are the educational needs of individuals?
- Does the specificity of adult education require a different approach to quality assurance and development?
- Are the educational programs of enough quality?
- What is the role of employees in quality assurance and development in adult education?

When introducing quality monitoring into adult education, we must also consider the specificities of adult learners, which are reflected in the diversity of needs, different backgrounds and their different work and social roles. Basic factors of quality assurance include (Možina, 2003):

- Active leadership and management – an essential element in deciding quality in adult education.
- Orientation to the learner – partnership in defining and assessing the quality of the educational process and achievements.
- Identifying knowledge needs as a prerequisite for quality educational provision.
- Developed lifelong learning culture – a cornerstone of employee competence and ongoing development.
- Openness to the local and international environment – to facilitate adaptation to change and impact on society.
- Developmental planning and ongoing evaluation of core processes.

For the education organization to achieve continuous improvement, it must be focused on the participants in the training, and this should not only be a commitment of management, but of all employees. It is necessary to know and understand the wishes of the participants in the education. Management can obtain this information through surveys or interviews of potential and existing learners. The flow of necessary information from education participants to management is better in less bureaucratic organizations. In order to better understand and know the needs and expectations of education participants, the leadership of educational organizations must employ the right people, who must also be constantly educated and advanced in this field. Of course, it is the leadership that must provide the necessary education to employees. One of the key elements of a high-quality adult education service is to become a learner.

Everyone who participates in the educational process as a participant expects a high-quality service, i.e. one that inter alia includes the quality of teaching. Finally, let's look at the factors that determine the quality of teaching (Guolla, 1999):

- Teachers' experience with teaching, their professionalism, motivation and assistance to learners in learning.
- The lecturer's enthusiasm for the course subject matter, which is reflected in the participant's perception of the lecturer's energy and ability to maintain a high level of attention.
- Organization of lectures, study materials and lectures.
- Interactions that are reflected in the perception of the lecturer's ability to stimulate discussions within the learning process itself.
- Interpersonal relationships that are reflected in the lecturer's perception of being friendly, attentive and approachable.

- Breadth that is reflected in the lecturer's ability to present alternative dimensions of the teaching subject.

It should be explicitly emphasized that educational organizations must have adequately trained staff, who must continually improve and educate themselves. All those who are in any way related to education must have a common goal, that is, to offer the education participants a quality educational process that will be based on their needs and expectations. However, how individual educational organizations are successful in achieving this goal certainly depends on the quality model they put into their service delivery process.

Cheng and Tam (1997) propose seven different models of quality in education, as can be seen in Table 2. These models differentiate quality criteria and could be used to deepen our understanding of quality in education, and further to develop better management strategies.

Table 2. Quality Models in Education

	Conception of education quality	Conditions for model usefulness	Indicators/key areas for quality evaluation (with examples)
Goal and specification model	Achievement of stated institutional goals conformance to given specifications	When institutional goals and specifications are clear, consensual, time-bound, and measurable When resources are sufficient to achieve the goals and conform to the specifications	Institutional objectives, standards, and specifications listed in the programme plans, e.g. academic achievements, attendance rate, dropout rate, etc.
Resource-input model	Achievement of needed quality resources and inputs for the institution	When there is a clear relationship between inputs and outputs When quality resources for the institution are scarce	Resources procured for institutional functioning, e.g. quality of student intake, facilities, financial support, etc.
Process model	Smooth internal process and fruitful learning experiences	When there is a clear relationship between process and educational outcomes	Leadership, participation, social interactions, classroom climate, learning activities and experiences, etc.
Satisfaction model	Satisfaction of all powerful constituencies	When the demands of the constituencies are compatible and cannot be ignored	Satisfaction of education authorities, management board, administrators, teachers, parents, students, etc.
Legitimacy model	Achievement of the institution's legitimate position and reputation	When the survival and demise among education institutions must be assessed When the environment is very competitive and demanding	Public relations, marketing, public image, reputation, status in the community, evidence of accountability, etc.
Absence of problems model	Absence of problems and troubles in the institution	When there is no consensual criteria of quality but strategies for improvement are needed	Absence of conflicts, dysfunctions, difficulties, defects, weaknesses, troubles, etc.
Organizational learning	Adaptation to environmental	When institutions are new or changing	Awareness of external needs and changes, internal

Source: Y. C. Cheng in W. M. Tam, *Multi-models of quality in education*, 1997, str. 24.

These models have their strengths and weaknesses, focusing on different aspects of the quality delivery process in education. The authors emphasize that their usefulness is not universal in all situations and is often limited by contextual conditions. An individual model may therefore be appropriate in certain circumstances and may not be applicable in others.

Traditionally, many organizations tend to use these models separately for quality assurance, but we must pay attention to their interconnectedness and take a holistic approach to management and quality assurance in education. From a systemic point of view, these models are interconnected and their interrelationships could be analysed as follows (Cheng & Tam, 1997): as a system, input, process and result of an educational organization and feedback loop from result to input forms a chain in which the performance of one side effects the other. The goals of an educational organization, including goals for inputs, processes, or results, may reflect the expectations, needs, and specifications of anyone who is in any way related to the educational organization. Obtaining limited resources to operate effectively and to ensure appropriate internal processes and extensive learning experiences are essential to achieving the goals set and achieving high quality educational outcomes. Achieving the set goals and compliance with the specification can lead to the satisfaction of all participants. Likewise, by establishing relationships with the broader community, building a reputation in the public, and demonstrating responsibility, an educational organization can achieve a legitimate position for its livelihood and a reputation for quality. By closely monitoring its programs and checking for signs of inefficiency through feedback, the educational organization can ensure that there are no problems in the quality of education. Finally, educational organizations continue to improve and evolve in all relevant aspects by learning from their mistakes and mistakes in their environment. All models should be used in order to achieve overall quality in education. In other words, all seven quality models in education are important for long-term planning and achievement of overall quality. This may be why the philosophy of holistic quality management is beginning to be strongly promoted in the field. Important elements of integrated quality management in education are targeting all participants (lecturers, management, students, etc.), continuous improvement of processes, and joint participation and empowerment of all participants. So, to a large extent, TQM is a concept that combines all seven models presented, especially the organizational learning model, the satisfaction model and the process model. Therefore, the concept of integrated quality management is given further attention in the following.

TQM (Total Quality Management) in education

The previous section defines the quality management of educational services and presents the individual stages in the educational quality management process. If an organization wants to improve its competitive position, it must meet the quality standards set by itself and the society. However, in addition to these standards, the consumer aspect of quality must also be considered. The problem is that quality in education is difficult to define, which in turn means that it is also difficult to define the criteria by which quality should be measured and difficult to compare with other educational organizations. In addition, quality can mean something different to everyone. Credibility and the fulfilment of promises made previously are also essential. However, we must start from the fact that the quality of service begins for people, that is, for all employees of an educational organization, with the sum of lecturers, management, other professional staff, and support services in mind. Their positive orientation and customer orientation can be increased by coordination, which begins with the selection of employees, care for employee development, creation of a pleasant working environment, i.e. by implementing inward marketing strategies. In

order to avoid complacency, contentedness with the achieved, it is necessary to introduce programs for quality improvement or for the continuous improvement of quality. The importance of education for the development of excellence, expertise and knowledge leading to overall development in economy cannot be undermined. This has necessitated a sound strategy for the development of higher education in almost all countries around the world. Establishing leadership is possible only when we have a developed system of higher education in which efficiency remains the sole criterion to evaluate performance. The system of higher education is found efficacious in making available to society a dedicated, committed, devoted, and professionally sound team of human resources to decide the future of any nation. This is possible only when the principles of quality management are inculcated in the system of higher education. Total Quality Management (TQM) is an inevitably common factor that will shape the strategies of higher educational institutions in their attempt to satisfy various stakeholders including students, parents, and society in general (Ali and Kumar, 2010). It is no coincidence that many educational organizations have already implemented the concept of TQM in their businesses, enabling them to achieve business excellence.

In view of the demand for higher quality, to date many authors have introduced the principles of integrated quality management in many areas of education as a step towards establishing better governance in the sector. TQM helps to achieve and maintain excellence in education (Sakthivel et al., 2005) as its principles and concepts bring many benefits to education, including improving morale, reducing costs, and improving efficiency and responsiveness to consumer needs (Elmuti et al., 1995). Total quality management is a core philosophy based on meeting consumer needs. Therefore, it is very important for the success of an organization that undertakes an integrated quality management initiative to clearly understand what the consumer or environment wants, needs, and expects (Pečar, 2007).

There is a prevailing belief that education has entered a new environment in which quality plays an important role. The quality of education has long been a key factor in "invisible" competition between countries, since the quality of products and services is determined by the way "managers, teachers, workers, engineers and economists think, make and make quality decisions" (Owlia & Aspinwall, 1997). Quality, especially in education, is what the consumer says is that because the "product" created is invisible, intangible, and unanalysable, and errors cannot be identified. If consumers are completely satisfied with the service an organization provides them, then quality is acceptable. This is why customers must be precisely defined, because only precise customer knowledge allows us to determine the success or failure of our commitment to quality (Michael et al., 1997). Although the concept of TQM has its developmental origins predominantly in the private sector, strong pressure can be felt upon its acceptance into educational organizations (Owlia & Aspinwall, 1998; Srikanthan & Dalrymple, 2004; Telford & Masson, 2005). Several researchers (Susan, 1995; Bath et al., 2004; Peat et al. In Venkatraman, 2007) believe that the principles of TQM can significantly help improve education, especially in the direction of curriculum reform.

Educational organizations began to introduce the concept of TQM in the late 1980s as a solution to ensure the continuous improvement of the quality of their educational services. As such, the application of TQM has gone through three main tasks: focus on meeting consumer demands, increase efforts for continuous improvement, and integrate all elements of the organization into participating in quality improvement programs (Ardi et al., 2012). To ensure the success of TQM implementation in education, Ardi et al. (2012) emphasize that the leadership of these organizations must understand the quality dimensions that underlie TQM so that they can develop more integrated

quality programs acceptable to each organization. Considering that education participants are the consumers for whom the services are provided, the satisfaction of education participants is an indicator of the successful implementation of TQM in an educational organization. Due to the need for greater understanding of TQM in educational organizations, Lagrosen et al. (2004) explore the quality dimensions that underlie TQM. They find that seven dimensions represent factors that affect quality.

Based on these findings, Sakhivel et al. (2005) develop a 5C TQM academic excellence model consisting of five dimensions of quality: commitment to top management, course delivery, campus facilities, courtesy and customer feedback and improvement; and link these dimensions of quality and student satisfaction. The authors then develop a multi-dimensional model, namely consumer focus, communication, a comfortable learning environment, and continuous assessment and improvement.

Michael et al. (1997) state that "TQM can be defined as a general management philosophy and a set of tools that allow an institution to pursue a definition of quality and a means for achieving quality, with quality being a continuous improvement as determined by customers' satisfaction with the services they have received. It indicates the flexible aspect of TQM, i.e., it is applicable to any organization and subject to adjustment as per merit of the situation." With the assistance of TQM, an academic institution can develop its own meaning of quality, standard, and quality enhancement practices regarding requirements of customers.

Today, these dimensions of TQM can be found in accreditation procedures or criteria for accreditation in higher education study programs and at higher education institutions, as well as in the evaluation of study programs and educational organizations. The criteria consider agreed standards and guidelines for quality assurance applicable in the European Higher Education Area. Important areas of assessment are the quality assurance system, which understands all the processes that are important for the excellent functioning of the higher education institution and the quality of the implementation of study programs, as well as the quality culture, which refers to the positive attitude of employees, students, and other participants from higher or higher education institutions to continuously improve the implementation of its activities and incorporate it into the identity and strategy of the higher or higher education institutions. In performing these procedures, the relationship with all stakeholders involved in or related to higher education is also important: students, higher-education teachers and associates, researchers, employers. The areas of assessment themselves cover the key activities of higher education institutions and higher education institutions in terms of organization and implementation of study programs; areas are judged in terms of inputs, processes and achievements. Areas subject to the quality assessment of a higher education institution are integration into the environment, the functioning of the higher education institution, staff, students, material conditions (premises, equipment, library and information activity and financing) and quality assurance, innovation, and development orientation (Nakvis, 2010).

From the above we can summarize that certain standards must be met for successful accreditation or evaluation. In this regard, the question arises about the essence of TQM and other concepts that place customer satisfaction at the centre. The result of securing such standards is a really satisfied consumer. can education services be standardized at all? In this connection, it is reasonable to consider the phrase offered by Juran (in Pečar, 2007): "readiness for use and purpose". The importance of this idea is that a service, in our case an educational service, can meet its specifications, but it does not achieve its purpose. Specifications may be incorrect or may not

meet consumer requirements. Achieving specifications is a necessary precondition for quality in most cases, but insufficient. For this reason, Juran (in Pečar, 2007) also develops a quality planning map, which also applies to education and consists of the following steps:

- determining who the consumers are;
- addressing the needs of these consumers;
- translating these needs into the language of the educational organization;
- developing an educational service that can meet these needs;
- optimizing the features of the service to meet both the needs of the educational organization and the needs of consumers;
- process optimization;
- demonstrating that the process can produce an educational service under operational conditions;
- process transfers to operations.

Many organizations have been very successful in implementing TQM, while not taking full advantage of the concept. When using TQM philosophy in an organization, some managers believe that quality arises due to the productivity of internal programs or the participatory management of programs that may deviate from their core business, and that consumer orientation is reflected in cost overruns. It is therefore very important for an educational organization to focus on its core business, namely learning and teaching, when implementing TQM.

The reason for resistance to the introduction of TQM in education is primarily the misunderstanding of the concept itself, since it is in fact such a wide collection of different philosophies that it is difficult to define. Therefore, when used in education, it is better not to talk about quality management in general, and instead to use philosophies and try to introduce them where appropriate. The word “integrity” means, above all, an approach that considers all aspects of the activity (for example, in schools not only the activities of each group, but also support and leadership activities, the quality of the premises, and the teaching material). Improvement similarly should not be based solely on the opinions of the principals and teachers/trainers, but also on the opinions of learners, society, schools, and the businesses that will employ the trainees in the future. It also follows from the word 'comprehensive' that 'management' is not merely part of an educational organization that must be held accountable; instead, the word "management" in the concept implies that the approach must be systemic, aiming at continually improving the non-level areas as it should. Of course, keeping the system running is a task for management, while the rest of the staff and learners are a resource for improvement and ideas. Finally, "quality" means that the educational organization constantly meets the expectations and requirements of all parties involved in order to be "good enough" in all areas. So, whenever the requirements (environment) and expectations change, the educational organization should notice it and implement improvements accordingly. And here, a “managed” systematic approach is needed (Pečar, 2007).

Integrated quality management in education means a more recent approach. According to Harris, there are three basic definitions of TQM in education (Kwan, 1996, p. 25):

- The first is consumer focus, where the idea of educational services is promoted through training and development of employees.
- The second is the focus on employees who, through values and greater contribution, influence the effectiveness of an educational organization.
- The third concern is the implementation of standards through key measurable elements of the educational process.

There are dilemmas in the literature about the appropriateness of introducing TQM in educational organizations. Some authors cite the lack of need for change as a problem.

While educational organizations are home to learning and knowledge creation through their research function, it is ironic that in them the concept of TQM began to be implemented much later than in other organizations. Probably the reason lies in the structural and traditional attributes of educational organizations. Also, the reason is probably the specific challenges that other organizations do not face. It is these specific attributes that make it difficult for educational organizations to implement TQM (Sirvanci, 2004).

Leadership, which is one of the essential elements in the implementation of TQM, as it triggers cultural change in the organization, does not enjoy ultimate authority in educational organizations as corporate managers. While management can set goals, define value and expectations, the lack of authority required makes it difficult to accept changes across the organization for all employees. The TQM philosophy is a dynamic approach that is driven and sustained by leadership. Leadership in an organization must be the first to undertake an approach to working in accordance with the vision and philosophy of TQM and transfer it to other levels in the organization. In accordance with the TQM philosophy, managers must constantly promote the TQM philosophy among their employees (Možina, 2003).

Organizations implementing TQM must also transform their culture into a culture of holistic quality that includes elements such as teamwork, consumer and market orientation, employee involvement and participation, and process management. Educational organizations with a long tradition tend not to favour change (Motwani & Kumar, 1997). Indeed, the culture associated with education is historically different from the prevailing culture in other parts of the private sector (Holmes and McElwe, 1995). Student involvement and teamwork, on the other hand, can pose a threat to the autonomy of an educational organization (Fischer, 1993 in Motwani & Kumar, 1997, p. 131). With the adoption of TQM culture, educational organizations need to shift from product orientation to the market.

Of all the elements of TQM, customer orientation is probably the most important. Consumer satisfaction is often used as a synonym for quality, and quality is defined as meeting consumer expectations. One of the key steps in implementing TQM is identifying current and potential consumers. Consumer focus determines the direction and goals of improvement, and consumers and the market are the driving force behind the pursuit of quality. There is a great deal of disagreement in consumer recognition about who the actual consumers are. It is also difficult to recognize their expectations (Meirovich & Romar, 2006). While most staff in educational organizations view students in classrooms as consumers, especially in cases where service education participants must pay for themselves as treated like consumers (Eagl & Brennan, 2007), others again believe that this view is too commercial. Eagl and Brennan (2007) believe that the use of marketing metaphors is only detrimental to the educational process. Consumers of educational services can thus be classified as students, graduates, employees, parents, and the local community. Consumers are therefore very diverse, their interest's contradictory, and their needs too vague to effectively introduce TQM. Authors Meirovich and Romar (2006) agree that it is difficult to focus on something so diverse, contradictory, and unclear. Still, only the part that represents a practically useful organizational transformation approach to quality improvement can be taken from the TQM approach. No matter what, without accurately identifying the consumer or audiences and consumer orientations, the quality efforts may quickly disperse. All authors who identify users of educational

services include students on their list. Moreover, students are the centre or the main consumers and, most of the time, effort and activity is directed towards this very group. While we agree that students are consumers, we must ask ourselves, are students the only consumers of educational services? In other words, is being a consumer their only role, are they acting in any other roles that are not sufficiently described? Often, students are treated as input at the beginning and as a product at the end of the educational process (Sirvanci, 2004; Willis & Taylor, 1999), which is not entirely accurate. The essential difference between production and service products is that consumers participate in the service process. Educational organizations are service organizations and students, as consumers, participate in the learning process; without their participation the process would not be efficiently conducted. The result of the process or the added value in the process is not the student itself, but the intangible result, consisting of the student's knowledge, practical skills, and learning ability (Meirovich & Romar, 2006).

It is clear, then, that educational organizations are service organizations, but if we look very closely, they may remind us of the flow of products in a manufacturing company (Sirvanci, 2004). Figure 6 shows the flow of students in a higher education organization. The resemblance to a typical production organization is immediate. Once admitted, students navigate through the various courses required to obtain an education, just like the raw materials that go through the gradual stages of development in the production process. Just as the final product bears the name of the brand, so the graduate receives a diploma, demonstrating the acquired knowledge in relation to the level of education completed. In this context, product similarities are graduates competing for specific jobs, just like products for market buyers. Based on Figure 26, graduates can therefore be interpreted as finished products and employers as buyers of educational organizations. This similarity can be very useful in implementing TQM in educational organizations, given that the TQM philosophy is most successful in manufacturing companies.

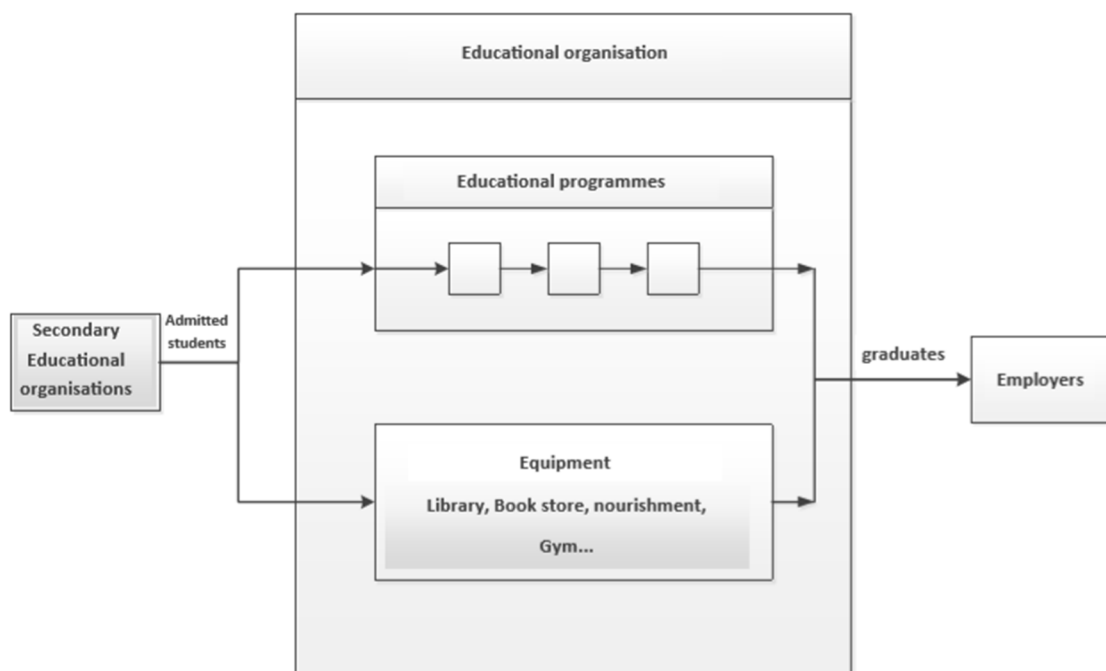

Figure 6: Student flow in an educational organization

Source: Adapted from M. B. Sirvanci, Critical issues for TQM implementation in higher education, 2004, str. 384.

According to many experts, TQM remains the minimum general requirement for remaining in a business that is dictated by social and market changes. There are still sceptics among researchers regarding the implementation of TQM in education, since we cannot compare education with the economy (Kohn, 2003). Kohn emphasizes that achieving high marks in education as a measure of success in implementing TQM is a major misunderstanding of TQM principles. The first problem with TQM's application to education is therefore the inadequate interpretation of TQM's philosophy and insufficient understanding of the processes that differ in education as compared to the economy. This may be due to a lack of required TQM knowledge.

A common barrier to both the private sector in general and education in specific in implementing TQM is a lack of proper leadership. Leadership must be able to establish a viable vision and drive change, providing the resources necessary to achieve the vision.

Employee resistance is certainly an obstacle in education that can be highlighted. This can be especially perceived in higher education, where they are mainly staffed by professionals who have traditionally enjoyed autonomy and academic freedom. Of course, we should ask ourselves what this academic freedom really means. Academic staff operate in a free environment, and the performance of their work is judged on completely different principles from the economy. Their freedom lies in the creation, research, dissemination of knowledge, concepts, information, and practical solutions. Intellectual freedom should, in fact, mean doing the right things in the right way for the consumer and in an efficient way. Unfortunately, academic freedom is often thought of as: "I know best – what I propose will be accepted" (Zairi, 1995). Academic staff are unlikely to favour changes in teaching styles. Education professionals are more inclined to teach than to implement TQM. Poor syllabi in education also lead to quality errors, and, as Kohn (1993) thinks, when implementing TQM, we should focus more on the syllabus than on learning, checking that the syllabi are properly integrated in the learning process itself.

TQM's application to education is seen to make the sector more relevant and respond to the needs of employers and other social sectors.

The basic principles of TQM that apply to education are (Eagl & Brennan, 2007):

- Impress the customer: enthusiasm means that we are the best at what matters most to the customer and that changes over time; to follow these changes and to inspire the customer now and in the future is an integral part of TQM;

- People-based management: knowing what and how to work and receiving performance feedback is one way to encourage people to take responsibility for the quality of their work; involvement and dedication to customer satisfaction are ways to create it;

- Continuous Improvements: continuous enhancements or changes to all of an organization's activities are the goal of all who want to achieve perfect quality; quality is a process that is never completed; continually improving and finding better ways to act in our own way is a constant task for all employees of the organization;

- Fact-based management: decisions to make improvements and make necessary changes to certain processes must be based on objective and relevant data, facts, and arguments; knowing the level of current performance of products or services by consumers and all employees is a first step for future improvements; management must manage facts at all stages based on facts; this information should also be provided to people so that decisions are made on the basis of facts and not on the basis of "feeling"; this is essential for continuous improvement.

Organizations that adopt these principles and the core characteristics of TQM are well on their way to achieving holistic quality management and can benefit from a variety of implementation processes. Most importantly, the organization first creates a mission statement or vision of its operations. The mission statement, which is formulated clearly and with the participation of all employees, greatly contributes to the initiation of other processes below, as well as to the organization's overall quality assurance and development. Systematic training of employees is important for the successful implementation of TQM, especially in order to ensure the participation of all employees in quality assurance activities (Van den Berghe in Možina, 2003).

TQM itself is more than a useful tool. It is based on a set of values, a process of continuous improvement, an active participation of the individual in organizational life, and on meeting the needs of internal and external participants, thus creating a systematic synergy between the participants. These values are different, and in order to best implement them in an organization, each educational organization must find its own way of implementation (Pečar, 2007).

We believe that marketing or profit organizations can learn a great deal about quality from educational organizations and vice versa; schools or educational institutions can significantly improve their quality with the help of TQM, but quality care requires new ways of thinking and acting; quality management must be conducted from both external and internal consumers. Educational organizations must be aware that quality is a concept that has different meanings for different participants, and, therefore, must listen to their perceptions in designing quality care systems. As the consumer must take an active part in the provision of the educational services, such participation should be properly encouraged and managed. It is therefore very important to know the factors that lead to consumer satisfaction. Instead of trying to find a good set of quality definitions in education, it makes more sense to focus on those dimensions that create quality and reach some social consensus on them. Considering the marketing aspect, it makes sense for educational organizations to consider that consumers perceive their services according to their values, investments, and creative abilities. Educational services must not only meet norms and regulations but must maintain and increase consumer comfort. However, some precaution is needed, since the endless response to the needs and desires of consumers in education is limited by legislation itself. Especially in the field of adult education, where many choose to pursue higher education because of the need to retain their jobs, or because of a desire for promotion or better employability, needs and desires are often contrary to ethics and morals. They want to get their education easily, with as little effort and time as possible. In this context, the pedagogical aspect of quality is at odds with the marketing concept of quality based solely on the consumer's needs and expectations. The question is, to what extent should educational organizations meet the needs and wants of their consumers. Of course, one can also ask in the marketing concept whether it really makes sense to satisfy every consumer's wish, or whether it would ever be better to set boundaries.

Conclusion

Based on the survey of the literature, we can identify some research issues that require attention from researchers and practitioners (i.e. the relation between various attributes or measurement issues). The review of the mentioned service quality models highlighted various issues, debates, strengths, and weaknesses pertaining to the models. It is noted that the models have a focus on only one link (i.e. either marketer to consumer or front-line staff to supporting staff). From the study of these models, it appears that the key ingredients to service quality improvements are a clear market and customer focus, motivated staff, a clear understanding of concepts of service quality and

factors affecting the same, an effective measurement and feedback system, an effective implementation system, and an effective customer care system. All these components are also crucial for improving the quality of education, which, by all its attributes, is service-oriented. Traditionally many people tend to use these models separately to ensure quality in education. But we should pay attention to their interrelationship and use a comprehensive approach to apply them in managing education quality. It seems that every model reflects different emphases on various aspects of an education institution in pursuing quality. In order to achieve total quality in education, the application of all these models may be necessary. In other words, all models of quality in education should be important in long-term planning for achieving total education quality. This may be the reason why total quality management in educational institutions has been so strongly emphasized recently. The critical elements of total quality management in an educational institution include focus on strategic constituencies (e.g. parents, students, etc.), continuous process improvement, and the total involvement and empowerment of members. According to the concepts of total quality management, quality in education can be comprehensively ensured if an educational institution can involve and empower all its members in functioning, carry out continuous improvement in different aspects of internal process, and satisfy the requirements, needs, and expectations of its powerful external and internal constituencies even in a changing environment (Yin, et al 1997).

Some might be sceptical about the success of total quality management in higher education, due to obstacles such as insufficient trust between departments and faculty members' low confidence level or ability to manage the process of total quality management. There are other questions regarding the applicability of this method to educational institutions. First, many institutions generally do not accept the need for change. Second, total quality management requirement that students are involved as customers and part of the 'teamwork', are accepted as a threat to the faculty's autonomy. Faculties balk at the idea of having a student as a customer, as in the "the customer is always right" type of scenario. Hence faculties and administrators tend to hold the belief that they know what the students need. Total quality management urges for long term planning, which is also dynamic, since the plan is subject to continuous review and revision. It is important to ensure the acceptance and inter-nationalization of the concept of total quality management, along with its theoretical constructs. Total quality can only be achieved by establishing an innovative organization, one that is flexible, that adjust quickly to changes in its environment, and is capable of learning. To improve education quality, an essential factor of economic and social development in the 21st century, it is crucial to reduce the huge amount of knowledge students are supposed to master, focusing their attention to a system of basic knowledge, on creativity, problem-solving, and lifelong learning. Educational institutions play an important role in the development of national economies, of society, and of its individual members through high-quality educational services. Thus, total quality management in education is geared for the development of 'total quality mind' and provides an important opportunity to assess quality in a holistic fashion, along with instruments for managing quality.

References

- Ardi, R., Hidayatno, A., & Zagloel, T. Y. M. (2012). Investigating relationship among quality dimensions in higher education. *Quality Assurance in Education*, 20(4), 408–428.
- Barkley, B. J., & Gupta, A. (1994). Improving service quality with information technology. *International Journal of Information Management*, 14, 109–121.
- Barnes, C. (1994). *Practical Marketing for Schools*. Oxford: Blackwell.

Bitner, M. J. (1992). Servicescapes: The Impact of Physical Surroundings on Customers and Employees. *Journal of Marketing*, 56(4), 57–71.

Brady, M. K., & Cronin, J. (2001). Some new thoughts on conceptualizing perceived service quality: a hierarchical approach. *Journal of Marketing*, 65, 34–49.

Bregar, L., Zgajster, M., & Radovan, M. (2010). *Osnove e-izobraževanja*. Priročnik. Ljubljana: Andragoški center Slovenije.

Brogowicz, A. A., Delene, L. M., & Lyth, D. M. (1990). A synthesised service quality model with managerial implications. *International Journal of Service Industry Management*, 1(1), 27–44.

Chang, T. Z., & Chen, S. J. (1998). Market orientation, service quality and business profitability: a conceptual model and empirical evidence. *The Journal of Services Marketing*, 12(4), 246–264.

Cheng, Y.C., & Tam, W.M. (1997). Multi-models of quality in education. *Quality Assurance in Education*, 5 (1), 22-34.

Cronin, J. J., & Taylor, S. A. (1992). Measuring service quality: a re-examination and extension. *Journal of Marketing*, 56, 55–68.

Dabholkar, P. A. (1996). Consumer evaluations of new technology-based self-service operations: an investigation of alternative models. *International Journal of Research in Marketing*, 13(1), 29–51.

Dahlgaard, J., Kristensen, K., & Kanji, G. (1998). *Fundamentals of Total Quality Management*. London: Chapman&Hall.

Eagle, L., & Brennan, R. (2007). Are students customers? TQM and marketing perspectives. *Quality Assurance in Education*, 15(1), 44–60.

Elmuti, D., Kathawala, Y., & Manippallil, M. (1996). Are total quality management programmes in higher education worth the effort? *International Journal of Quality & reliability Management*, 13(6), 29–44.

Ennew, C. T., Reed, V., & Binks, M. R. (1993). Importance-Performance Analysis and the Measurement of Service Quality. *European Journal of Marketing*, 27(2), 59–70.

Etzel, M. J., Walker, B. J., & Stanton, A. (1997). *Principles of Marketing*. (11th ed.). New York: Prentice Hall, Englewood Cliffs.

Faganel, A. (2010). *Zaznavanje kakovosti visokošolskih storitev*. Koper: Fakulteta za management.

Feigenbaum, A. V. (1989). Seven keys to constant quality. *Journal of quality and participation*, 12(1), 20–23.

Ferjan, M. (1999). *Organizacija izobraževanja*. Kranj: Moderna organizacija.

Fitzsimmons, J. A., & Fitzsimmons, M. J. (1998). *Service Management*. Boston: McGraw-Hill.

Ford, J. B., Joseph, M., & Joseph, B. (1999). Importance-performance analysis as a strategic tool for service marketers: the case of service quality perceptions of business students in New Zealand and the USA. *The Journal of Service Marketing*, 13(2), 171–186.

Frost, F. A., Kumar, M. (2000). INTSERVQUAL – an internal adaption of the GAP model in a large service organization. *Journal of Services Marketing*, 14(5), 358–377.

Garvin, D. A. (1991). *Competing on the eight dimensions of quality, Uncinditional Quality*. Cambridge: Harward Business Review..

Grönroos, C. (1984). A service quality model and its marketing implications. *European Journal of Marketing*, 18(4), 36–44.

Grönroos, C. (1990). *Service Management and Marketing*. Massachusetts/Toronto: Maxwell Macmillan International Editions.

Grönroos, C. (2000). *Service management and marketing – A consumer relationship approach*. Chichester: John Wiley & Sons.

Guolla, M. (1999). Assessing the teaching quality to student satisfaction relationship: Applied customer satisfaction research in the classroom. Statesboro. *Journal of Marketing Theory and Practice*, 7(3), 87–97.

Hallowel, R. (1996). The relationship of customer satisfaction, customer loyalty, and profitability: an empirical study. *International Journal of Service Industry Management*, 7(4), 27–42.

Harvey, L., & Green, D. (1993). Defining quality. *Assesment and Evaluation in Higher Education*, 18(1), 9–34.

Haywood-Former, J. (1988). A conceptual model of service quality. *International Journal of Operations&Production Management*, 8(6), 19–29.

Ho, H. F., & Hung, C. C. (2008). Marketing mix formulation for higher education. An integrated analysis employing analytic hierarchy process, cluster analysis and corespondence analysis. *International Journal of Educational Management*, 22(4), 328–340.

Holmes, G., & McElwee, G. (1995). Total quality management in higher education: how to approach human resource management. *The TQM Magazine*, 7(6), 5–10.

Ivy, J. (2008). A new higher education marketing mix: the 7Ps for MBA marketing. *International Journal of Educational Management*, 22(4), 288–299.

Joseph, M., & Joseph, B. (1998). Identifying needs of potential students in tertiary education for strategy development. *Quality Assurance in Education*, 6(2), 90–96.

Joseph, M., Yakhou, M., & Stone, G. (2005). An educational institution's quest for service quality: customers' perspective. *Quality Assurance in Education*, 13(1), 66–82.

Kang, G. D., & James, J. (2004). Service quality dimensions: an examination of Grönroos's service quality model. *Managing Service Quality*, 14(4), 266–277.

Kaplan, R. S., & Norton, D. P. (2000). *Uravnoveženi sistem kazalnikov*. Ljubljana: Gospodarski Vestnik.

Koc, E. (2006). Extended review of Shakespeare, Einstein and the Bottom Line: The Marketing of Higher Education by D.L. Kirp. *On the Horizon*, 14(1), 19–21.

Kodrin, L. (2007). *Trženjsko zagotavljanje kakovosti izobraževalnih storitev: model za presojo kakovosti izobraževalnih storitev v srednjih šolah* (doktorska disertacija). Ljubljana: Ekonomska fakulteta.

Kohn, A. (1993). Turning learning into a business: concerns about total quality. *Educational Leadership*, 51(1), 58–61.

Kotler, P. (1998). *Marketing Management (Trženjsko upravljanje)*. Ljubljana: Slovenska knjiga.

Kump, S. (1996). *Sistemi in zagotavljanje kakovosti v izobraževanju*. Ljubljana: Andragoški center.

Kwan, P. Y. K. (1996). Application of total quality management in education: retrospect and prospect. *International Journal of Education Management*, 10(5), 25–35.

Lagrosen, S., Seyyed-Hashemi, R., & Leitner, M. (2004). Examination of the dimensions of quality in higher education. *Quality Assurance in Education*, 12(2), 61–69.

- Leonard, F. S., & Sasser, W. E. (1982). The incline of quality. *Harvard Business Review*, 60(5), 163–171.
- Lovelock, C. H. (1992). *Managing Services*. Englewood Cliffs: Prentice Hall.
- Lovelock, C. H. (1996). *Services Marketing*. Englewood Cliffs: Prentice Hall.
- Maringe, F. (2005). Interrogating the crisis in higher education marketing: the CORD model. *International Journal of Educational Management*, 19(7), 564–578.
- Maringe, F., & Foskett, N. H. (2002). Marketing university education: the southern African experience. *Higher Education Review*, 34(3), 35–51.
- Maringe, F., & Gibbs, P. (2010). *Marketing Higher Education. Theory and Practice*. McGrawHill: Open University Press.
- Mattsson, J. (1992). A service quality model based on ideal value standard. *International Journal of Service Industry Management*, 3(3), 18–33.
- Meirovich, G., & Romar, E. J. (2006). The difficulty in implementing TQM in higher education instruction. The duality of instructor/student roles. *Quality Assurance in Education*, 14(4), 324–337.
- Michael, R.K., Sower, V.E. and Motwani, J. (1997) A Comprehensive Model for Implementing Milekšič, V. (1999). *Ugotavljanje in zagotavljanje kakovosti v vzgoji in izobraževanju*. Ljubljana: Ministrstvo za šolstvo in šport.
- Motwani, J., & Kumar, A. (1997). The need for implementing total quality management in education. *International Journal of Educational Management*, 11(3), 131–135.
- Možina, T. (2003). *Kakovost v izobraževanju. Od tradicionalnih do sodobnih modelov ugotavljanja in razvijanja kakovosti v izobraževanju odraslih*. Ljubljana: Andragoški centre Republike Slovenije.
- Murad, A. and Kumar. R. S. (2010). Implementation of Total Quality Management in Higher Education. *Asian Journal of Business Management* 2(1): 9-16, 2010
- Nacionalna agencija Republike Slovenije za kakovost v visokem šolstvu. (2010). Merila za akreditacijo in zunanjo evalvacijo visokošolskih zavodov in študijskih programov. Ljubljana: Nacionalna agencija Republike Slovenije za kakovost v visokem šolstvu.
- Nicholls, N., Harris, J., Morgan, E., Clarke, K., & Sims, D. (1995). Marketing higher education: the MBA experience. *International Journal of Educational Management*, 9(2), 31–38.
- Owlia, M. S., & Aspinwall, E. M. (1997). TQM in higher education – a review. *International Journal of Quality & Reliability Management*, 14(5), 527–543.
- Parasuraman, A., Zeithaml, V. A., & Berry, L. L. (1985). A conceptual model of service quality and implications for future research. *Journal of Marketing*, 49, 41–50.
- Pečar, Z. (2007). *Kakovost v šoli. Primer uvajanja TQM*. Ljubljana: Fakulteta za upravo.
- Potočnik, V. (2000). *Trženje storitev*. Ljubljana: Gospodarski vestnik.
- Rau, T. (2011). *Novi ISO standard je usmerjen v izboljšanje kvalitete izobraževalnih storitev in olajšanje primerjave na svetovni ravni*. Najdeno 30. januarja 2013 na spletnem naslovu http://www.e-standard.si/index.php?page=95&action=article&article_id=16
- Reicheld, F., & Sasser, E. W. (1990). Zero defection: Quality Comes to Services. *Harvard Business Review*, 68(9/10), 105–111.
- Sakhivel, P. B., Rajendran, G., & Raju, R. (2005). TQM implementation and student's satisfaction of academic performance. *The TQM Magazine*, 17(6), 537–589.
- Sallis, E. (1993). *Total quality management in education*. Philadelphia, London: Kogan Page Educational Management Series.

- Sallis, E. (2001). *Total Quality Management in Education*. London: Kogan Page.
- Santos, J. (2003). E-service quality: a model of virtual service quality dimensions. *Managing Service Quality*, 13(3), 233–246.
- Scullion, R., & Nixon, E. (2011). *The Marketisation of Higher Education and the Student as Consumer*. London, New York: Taylor & Francis Group.
- Shank, M. D., Walker, M., & Hayes, T. (1995). Understanding professional service expectations: do we know what our student expect in a quality education? *Journal of Professional Services Marketing*, 13(1), 71–83.
- Silvestro, R., & Cross, S. (2000). Applying the service profit chain in a retail environment. Challenging the »satisfaction mirror«. *International Journal of Service Industry Management*, 11(3), 244–268.
- Sirvanci, M. B. (2004). Critical issues for TQM implementation in higher education. *The TQM Magazine*, 16(6), 382–386.
- Snoj, B. (1998). *Management storitev*. Koper: Visoka šola za management.
- Snoj, B. (2000). *Management storitev*. Koper: Visoka šola za management.
- Spreng, R. A., & Mackoy, R. D. (1996). An empirical examination of a model of perceived service quality and satisfaction. *Journal of Retailing*, 72(2), 201–214.
- Srikanthan, G., & Dalrymple, J. (2004). Developing alternative perspectives for quality in higher education. *International Journal of Educational Management*, 17(3), 126–136.
- Sureshchandar, G. S., Rajendran, C., & Anantharaman, R. N. (2002). Determinants of customer – perceived service quality: a confirmatory factor analysis approach. *Journal of Services Marketing*, 16(1), 9–34.
- Sureshchandar, G. S., Rajendran, C., & Anantharaman, R. N. (2002). The relationship between service quality and customer satisfaction – a factor specific approach. *Journal of Services Marketing*, 16(4), 363–379.
- Teas, R. K. (1993). Expectations, performance evaluation, and consumers' perception of quality. *Journal of Marketing*, 57(10), 18–34.
- Telford, R., Masson, R. (2005). The congruence of quality values in higher education. *Quality Assurance in Education*, 13(2), 107–119.
- Total Quality Management in Higher Education. *Benchmarking for Quality Management and Technology*, 4, 104-120. <https://doi.org/10.1108/14635779710174945>
- Ventakraman, S. (2007). A framework for implementing TQM in higher education programs. *Quality Assurance in Education*, 15(1), 92–112.
- Yin C. C., Wai M. T. (1997). Multi-models of quality in education. *Quality Assurance in Education*, 5(1), 22-31, <https://doi.org/10.1108/09684889710156558>
- Zairi, M. (1995). Total quality education for superior performance. *Training for Quality*, 3(1), 29–35.
- Zeithaml, V. A., & Bittner, M. J. (2003). *Services Marketing: Integrating Customer Focus across the Firm* (3rd ed.). Boston: Irwin McGraw-Hill.
- Zeithaml, V. A., & Parasuraman, A. (2004). *Service Quality*. Cambridge: Marketing Science Institute.
- Zeithaml, V. A., Parasuraman, A., & Berry, L. L. (1990). *Delivering Quality Service: Balancing Customer Perceptions And Expectations*. New York: The Free Press.

Julija Lapuh Bele

PhD, Assistant Professor, Ljubljana School of Business, Slovenia

orcid.org/0000-0003-4573-5409

FINANCIAL SCAMS, FRAUDS, AND THREATS IN THE DIGITAL AGE

***Abstract.** This article lays out the online scams, fraud, and threats that can jeopardize the financial assets of both individuals and organizations. As technology and society have progressed, so have criminal activities developed and adopted modern approaches. Nearly every legal and natural person is susceptible online. Fraudulent letters and other posts, often in poor Slovenian or other minority national languages, are becoming increasingly convincing, targeting specific individuals and their assets, or the assets of the companies for which they work. It thus depends solely on our level of awareness, knowledge, and level of precaution whether we fall for such scams. The risks must be well known in order to avoid bad decisions. This was the impetus to compile in this article various examples of scams, along with other tips and advice on how to avoid losing money online. Crypto assets were included in the selection of risks, as the potential for losing financial assets is immense among crypto investors.*

Introduction

Studies conducted by the OECD (Organisation for Economic Co-operation and Development) show that levels of financial literacy are globally rather low (OECD, 2016; OECD, 2017). It is unsurprising, then, that modern criminals exploit citizens' low levels of financial and IT literacy and awareness. Combatting this requires constant awareness and education campaigns, as the approaches of criminal networks evolve in step with the development of society and technology. Such criminal efforts variously seek to extract as much money as possible at the expense of uninformed, gullible, greedy, and/or naive people. Potential thieves stalk social networks, send emails, post fraudulent advertisements online, and otherwise attempt exploitation through a range of other mechanisms. Sophisticated tools and equipment are used in this pursuit.

Unfortunately, some scams are identified only after it is too late, as hucksters constantly invent new schemes, or a certain societal change must occur to uncover the fraud. Nonetheless, many underlying patterns are the same, and aware individuals can often recognize signs of potential traps. Scam and fraud have somewhat different meanings; a "scam is a clever and dishonest plan for making money", while "fraud is the crime of cheating somebody in order to get money or goods illegally" (Oxford Dictionary, 2019). Fraud is thus the result of a successful scam.

Certain financial scams were well established before the internet era and, despite their old age, they still work; they have merely been digitalized, modernized, and upgraded to match society's IT advances. Made possible by such advances, new scams and methods of fraud have also been invented.

One of the oldest and still quite active scams is the pyramid scheme. It is at least a hundred years old, ever since savings accounts became widespread.

As our era is dominated by the internet, this article will be focused primarily on online scams. Hyperconnection among modern communications outlets have drastically increased criminals' access to potential victims, a feature they fully exploit.

1. Pyramid Schemes

Pyramid schemes work as follows: people pay into the system. It is crucial that both the scam organizer and the honest investors attract as many new investors as possible. The organizers promise convincingly that investors will make massive amounts of money through very little work. Initially they pay out returns or dividends, in order to assure the influx of new investors. The longer the scheme lasts, the more investors pay into the system. Everyone expects their initial investment back whenever they need it, along with great returns. When the money dries up and the organizers fail to pay investors back, the system collapses. Many of the investors end up cheated, out of both their invested capital and the promised returns.

Pyramid schemes in the developed world are classified as criminal activity, which sadly does not prevent them from being attempted.

Ponzi Scheme

One of the first pyramid schemes was the Ponzi scheme, named after Charles Ponzi, who around 1920 promised investors 50% profit in 45 days or 100% profit in 90 days. He explained the secret as taking advantage of the difference in prices between American and Italian reply coupons for postage stamps. Within 6 months he raised \$15 million from 30,000 investors. Many invested their life savings, and others took out mortgages or other big loans, as the interest rates were lower than the promised returns. As long as money was coming in, Ponzi paid out profits. When he stopped attracting investors, he also stopped paying returns, and it became clear everything was a scam and that the invested capital was gone (US SEC, 2019).

Ponzi schemes are successful based on the amount of capital invested over a limited time, and on the influx of new investors. Investors thus receive high profits initially and, when they spread word publicly about their earnings, new investors are attracted and the cycle continues. New members are most often found through network marketing. There is a potential for profit as long as new investors feed into the system. When that flow trickles, so do payouts, and the investors discover that they have been tricked. In practice this means that the initial investors (generally the scheme's organizers) turn a profit, while everyone else loses their capital.

The biggest Ponzi scheme in history was staged by Bernard Madoff, who from 1991 to 2008 cheated investors out of \$64.9 billion. Madoff inspired investor confidence with his resume as the former president of the NASDAQ exchange and one of the world's greatest financial experts. His customers were rich businesspeople, known names in the entertainment and financial industries, as well as from humanitarian organizations. When he confessed that he could not pay back his investors, who demanded payouts due to the 2008 financial crisis, he was forced to admit that he had frauded them. Madoff's scam might have even continued if it were not for the crisis (Milivojevič, 2009). It is of interest how Ponzi schemes can last for decades, as frauded investors can end up losing significant amounts of money before realizing that everything was a scam.

Pyramid Schemes

Pyramid schemes work on the principle of network marketing. A fraudster starts things off, inviting fellow cheats and other naive but influential people. Their job is to recruit new investors. The entrance fee for new recruits is shared upward through the whole chain of recruited investors. The higher one is in the pyramid, the more money one stands to gain. It is in all investors' interest to acquire further investors, as this is the only way to turn a profit. The problem with such schemes is the pyramid's exponential base growth, which makes it mathematically impossible to find new investors. As a result only the highest members in the chain recoup their investment. The organizer, meanwhile, stands to make a lot of money, without investing even a cent.

Modern approaches replace scammed celebrities with videos containing false claims, where conned people promote how they struck it rich with the investment in question.

The most infamous pyramid scheme in Slovenia was Catch the Cash, which in the 1980s swindled at least 120,000 Slovenians, or at least 7% of the adult population. It would have been hard in those days to find a Slovenian who had not heard of this scheme. Despite media broadcasts educating people how the game was devised by professional fraudsters, new investors were found, and the game dragged on until no more fools were found. Estimates of the damage reached at least €50 million. This bad experience unfortunately did not prevent new pyramid schemes from popping up. Those who were cheated often prefer not to discuss their losses, so the financially clueless younger generation becomes as easy a target as their predecessors. Pyramid schemes are not a form of gambling or lottery; those games of chance, organized by the official lottery organization under the oversight of regulatory bodies, offer small chances of profit, but there is in fact a chance. In pyramid schemes, only the organizers stand to profit.

2. Financial Crime and Fraud in the Age of Cybersecurity

In 2018, the World Economic Forum noted that fraud and financial crime was a trillion-dollar industry and growing (Hasham & Dr., 2019).

Attempts at online financial scams have become so prevalent that the Slovenian police, Europol, and Interpol have all written at length about the issue on their respective websites. Their aim is to inform citizens about threats and urge them to take measures to protect themselves. The fact is that humans are the weakest security link and a little bit of knowledge can go a long way in helping prevent the loss of financial assets or the reputation of the companies for which we work. The goal of almost every scam is to acquire something from the victim. This is not always money, though money is the ultimate goal of most cybercrime.

In its 2019 annual report, Verizon¹ confirmed that the majority of success cybercrimes were financially motivated (Fig. 1). Compared to 2011, success rates have fallen somewhat, but that does not mean there are fewer attempts today. According to Europol, there is more and more traffic in cybercrime every year (Europol, 2019). Such cybercriminals use an arsenal of tricks, though so-called social engineering is among the most common methods. Put simply, users are called upon either to divulge important information or to provide unauthorized third parties access to their computer or network. Criminals know that most computers have more or less adequate technical security features that prevent harmful code or malware from breaching the system. Gullible victims who open the doors wide are thus a prerequisite.

There are two main types of financial scams: ones where money is secured through the promise of high-profit financial investments; ones where victims lose money directly.

Criminals use clever tricks and promises either to take money or valuable financial information from their victims. Scams featuring some lost and forgotten acquaintances, unknown but wealthy relatives, or lastly rich Nigerian princes are far from the only means of reaching that goal. Cybercriminals are becoming ever savvier and it is becoming harder to find them. Modern fraudsters do whatever it takes to make their way toward other people's money and/or bank information. In doing so they are willing to play a whole cast of roles, from directors to secret admirers (Police, 2019).

¹ Verizon is one of the largest communication technology companies in the world.

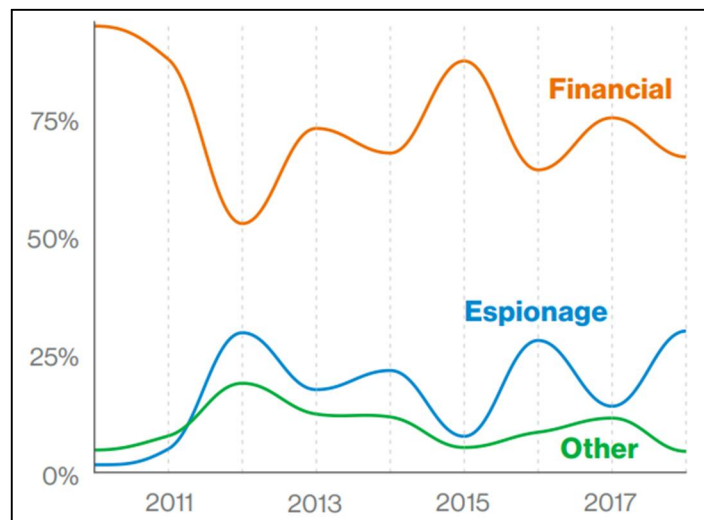

Fig. 1: Motives behind Breaches over Time
(Verizon, 2019)

Not knowing the dangers makes it harder to avoid them, so let us review some of the most typical online financial scam.

Investment Scams

Investment scams seem to offer users high-profit investment opportunities, such as currency exchanges, stocks, bonds, cryptocurrency or tokens, precious metals, real estate, or even cap and trade credits for carbon or other alternative energy sources. In short, the spectrum is broad. Fraudsters seize upon people's greed and naiveté.

Any offers of safe investments or guaranteed high profits and returns must be met with a healthy dose of skepticism.

Cheaters make means of a wide variety of methods.

Sometimes people whose advice we did not solicit cold call with a tempting investment offer. The caller always warns us that the time to act is now, lest we miss out on an incredible opportunity.

Similarly, we might receive an email from a stranger offering advice about the price of a certain company's stock. If we respond, the fraudsters often give the impression that their message was intended for someone else, and that we received it just by mistake; of course, they offer us the same opportunity, too.

Skepticism is the right response to ads on social media and to seminars that e.g. promote "no-risk investments", "millionaire in 3 years", or "how to get rich quick". We are invited to take part in a free introductory seminar, and then further meetings or educational models come with astronomical costs. The fraudster in promoter's attire either takes the victim's money or offers a loan to cover the costs of attendance at additional seminars, as well as for the investments that are sure to earn the victim a lot of money.

There are also advertisements for business opportunities that take advantage of celebrities. Their pictures or words are lifted out of context and pieced into an ad, article, or video, where said celebrity explains how a certain investment is bound to pay off. Such approaches were instrumental in the fraudulent investment portals Bitcoin Evolution and Bitcoin Revolution, which posted a fake interview between well-known Slovenian journalist Darja Zgonc and Melania Trump. Just like this video, most such advertisements are posted on social media, such as Facebook.

Money Mules

Criminals stealing money online need bank accounts into which to deposit their illegally acquired money. They cannot do so to their own accounts, as this would easily get them caught. Accordingly, they require accomplices, who for a fee are willing to lend out the use of their accounts. Such accomplices are called money mules.

Thus money mules are intermediaries used by criminal organizations to conduct transactions with contraband financial assets. They facilitate the transfer of funds between accounts and/or national borders, and the criminal organizations can then launder the money.

Illegally attained money or other assets is referred to as “dirty”, and it is “laundered” after its source has been obfuscated and it then appears as cleanly acquired. The ultimate goal of laundering is the gradual introduction of the newly clean money into the normal financial flows that constitute a legal business; such money is also reinvested into other criminal activity (<https://www.gov.si...>, 2019).

Law enforcement agencies first track down the holders of the account used to launder money. Such holders or money mules have committed a crime, albeit unknowingly. They can suffer a range of consequences as result, including long prison sentences.

In December 2019, Europol announced that it had identified 3833 money mules and 386 individuals who had abused them. Meanwhile the Slovenian police report that suspects in Slovenia (including foreigners) mostly laundered money from various online crimes, such as system breaches, successful solicitation of financial information, and other forms of cybercams (e.g. director scams, Nigerian prince scam, etc.). Further of note in Europol’s 2019 report was the fact that criminals are increasingly finding their victims on dating sites, where romantic conversations in time turn into convincing requests to open a bank account for money transfers. Also on the rise are ads on social media that promise quick profits. This technique is especially applied to young people and students (Europol, 2019).

A campaign was launched throughout Europe in December 2019 under the hashtags #dontbeamule (#nebodimula), aiming to spread awareness about money mules. Material available in 25 languages informed the public about criminal approaches to attracting money mules, as well as what potential victims can do to protect themselves or what to do if they have already been attacked (Europol, 2019).

Director Scam

Fraudsters find information on a company’s website, namely the full name and email address of the CEO and CFO. The CFO is sent an email with information presented such that it appears to have come from the CEO. It also contains instructions to pay a real or pro-forma invoice in the attachment. The listed account is under the control of a criminal or criminal network. Many CFOs have fallen for this scam, and the police have run media ads about it and posted information on their website (Police, 2019).

Awareness of such scams can lead to their prevention. Companies should put in place internal protocols for any financial transfers. The information made public on corporate websites should also be limited. Precaution is needed on social networks and in sharing information that could facilitate a criminal attack.

Criminals are always present online, sending countless emails a day. They succeed whenever someone falls for their tricks. The chances of getting our money back are slim to none, so prevention is the only method of protection.

Account Fraud

Someone contacts a company by phone, email, or letter, etc., claiming to represent a supplier, provider, or other trusted party. Their message announces changes in account information for all future invoices. The proposed new account is controlled by a fraudster.

Accordingly, great care is necessary when receiving notices about a change in account data. Prevention can be simple enough, e.g. just calling the old number or writing to the old email address, instead of interacting with the new representative.

Data Phishing

Phishing is a technique used to obtain sensitive information. Criminals send fraudulent messages in an attempt to lure recipients into revealing their personal, financial, and security information. Email is the most common mechanism.

Such email contains a link to a website that at first glance appears trustworthy. Usually it looks like a bank website, but in reality it is a fraudulent site controlled by criminals. As soon as we enter our information, it is used and abused.

Smartphones are also used for phishing, as criminals attempt to obtain information by text message or voice call. Fraudsters either solicit information from their victims, or convince them into outright money transfers.

Romance Scams

Fraudsters seek victims primarily on dating sites and social media. After initial contact, the fraudster expresses romantic feelings for their future victim and invites them to chat in private. The victims then reveal their information along with their weaknesses. The fraudster sometimes requests intimate photographs or videos, regularly penning emotional letters, sometimes also causing the victim to pity them. Time passes and the fraudster succeeds in obtaining the victim's trust. Then comes the request for money, gifts, or information from bank accounts or credit cards. If refused, the fraudster attempts blackmail; if successful, demands continue for even greater sums. The extortion never ends until the victim is broken.

Never, ever give money to strangers met online without being 100% sure of their identity. This advice is general, as offline fraudsters also primarily target the naive, particularly senior citizens and those living by themselves.

Personal Data Theft

Fraudsters find personal data on social networks and through false websites. Successful attempts earn them access to victims' bank accounts, leading to requests for credit or other forms of data manipulation. Often the purpose of data theft is resale to other fraudsters.

Many times an email address and other information is required to access some free service. Users regularly fail to realize that such data can be used against them. Thus we should keep confidential personal information like full names, addresses, telephone numbers, email addresses, birthdays, etc.

Nigerian Prince and Lottery Scams

Typical of these two scams is the promise of high profits on the condition that the victim must first make a transfer. Any promises of money under the condition that it is necessary to pay something first should seem extremely suspicious, as it is probably an attempted scam.

The Nigerian Prince scam takes advantage of people's greed and naiveté, having become a standard part of inbox spam.

The traditional form sees the fraudster send an email blast to several recipients, presenting themselves politely, often in the role of a successful businessperson, government official, or estate of some rich but unknown relative. The mail also explains that there is a problem. The first such scams were sent by “businesspeople from Nigeria” who explained their intent to launder money, promising millions as a reward for lending the use of a bank account. This led to them being referred to as “Nigerian” scams, though today their stories no longer feature Nigeria.

The victim of Nigerian scams are not money mules, who actually do receive money and rewards, as criminals require them in their network. The only goal of a Nigerian scam, on the other hand, is to extract money and personal data from victims.

Nigerian scams are a constant threat. Their underpinnings remain the same, with only the superficial story details changing. Examples of stories: you won the lottery, you won a sweepstakes that you didn’t even participate in, and you have inherited a lot of money.

The fraudster first contacts the victim with an attractive offer. Whoever responds is informed of the need to, because of one procedure or another, pay a minimal fee up front. The demand is for a transfer to an account that is hard to trace. Then the victim’s name and bank account number are requested. Soon the fraudster instructs the victim to cover the costs of opening the new account. New demands follow such as paying a tax, paying an accountant or lawyer, etc. When the victim stops paying these imaginary fees and demands their promised reward, communication is cut off.

Then the victims often realize that they were participating in a crime, or they are outright embarrassed to have been tricked, and thus many such scammers go unreported. Even if the scam is reported, the chances of getting the lost money back are practically zero, as the country of their origin often makes it difficult to launch a successful investigation, cf. e.g. Nigeria, Ghana, Cameroon, etc. (Europol, 2019).

Fraudsters find their victims through online advertisements, Facebook, and other social networks.

Fake Web Shops and Online Purchasing Fraud

As with most scams, the initial offer seems extremely attractive. The problem is simply that the ordered product never arrives. In the process we often also give up personal information, which the fraudsters can then sell ahead to other criminal networks or use to launch new scams.

Some websites offer premium brand names at extraordinary prices. Most such examples are stores with counterfeit products. The goods, if even sent, are seized at customs, and the purchaser loses their money, never gets their product, and is even lucky to avoid a fine.

3. Dangerous Traps for Crypto Traders

Cryptoasset investments are highly speculative, and the risk of losses is huge. Many crypto investment opportunities, especially token schemes, have turned out to be scams. Fraudsters in this field are especially active and innovative.

Crypto assets are so termed for two reasons; cryptocurrencies are joined on the market by other coins and other forms of digital ledger records. Central banks and regulators are unanimous in that cryptocurrency can be considered neither money nor foreign currency (www.bsi.si ..., 2018; ECB, 2019).

Thus cryptocurrencies and other forms of crypto assets take the form of unregulated digital records that are not issued or backed by a bank or other public organ. This means that no one guarantees them. It is legal to use cryptocurrency as a form of payment, though it has been shown to

be less than ideal due to price volatility, large transaction fees, and the slow speed of transaction confirmation.

Crypto schemes that facilitate purchase (exchanges), storage (digital wallets), and trading of crypto assets are not systematically regulated and lack oversight. This means that there is no body to license them or ensure the appropriateness of their risk management, their handling of employee expertise, their customer interactions, etc. Potential crypto investors must therefore be extremely aware of the specific nature of such risks, ensuring that their investment goals are aligned with the specifics of the market (www.bsi.si ...; 2018).

Since the beginning of cryptocurrencies and their market capitalization, Bitcoin has emerged as the most important currency. Its inventor Satoshi Nakamoto wanted to establish a decentralized digital monetary system. This means that it would be separated from a central regulatory body or server that confirmed transactions. Regulated digital monetary transactions are concluded through online bank systems. This makes them controlled, and banks and law enforcement agencies can investigate potentially illegal transactions and attempts at money laundering. This makes the system established by Nakamoto extremely attractive to the criminal underworld. A common tactic is to use extortion methods to force people into paying blackmail in bitcoins, as the payments are then untraceable. This means that it is in the interest of criminal organizations that financially important cryptocurrencies such as bitcoin stick around. Regulatory bodies meanwhile are seeking methods of limiting or even preventing crypto trading.

Most people are still quite in the dark about the world of crypto assets, but, due to a range of causes referred to by researchers as behavioral finance,² they nonetheless decide to invest. Investors should realize that this is a field where traditional mechanisms of protecting assets are almost entirely absent; investments should only be made with money we are willing to lose permanently.

Trading cryptocurrencies comes with a big risk. We pay real money for cryptocurrencies without ever knowing if our investment will be fungible in the future, i.e. if we will be able to trade it back for money or other goods.

Due to their once meteoric rise and lingering hope for similar rallies, cryptocurrencies like bitcoin, ethereum, and ripple attracted countless investors. Those who joined the bandwagon at the end of this bull market at the end of 2017 have significantly less money today than they did when they invested it, but they are still waiting for a rally in the future. Crypto exchange rates are driven by supply and demand, and no institution guarantees their payout value.

“Real” cryptocurrencies (e.g. bitcoin, ethereum, ripple, tether) are traded on exchanges. If you cannot find a certain currency listed on the biggest exchanges, it is a good sign that you should be extremely careful. Fraudsters’ claims should be regarded with a healthy dose of skepticism.

Since the crypto market is so unregulated, there are still a lot of unknowns, even for experts, making it an attractive area for criminals. Exchanges are a frequent target and in the event that customers’ assets are stolen, there is no guarantee that they will be reimbursed. There have already been several examples of theft through exchanges, and there will surely be more in the future. This makes it crucial to keep crypto assets stored in offline digital wallets that are not connected to the internet.

² The field of behavioral finance, which combines the study of psychology and finance, teaches us that there is a range of cognitive biases that can affect persons' decision-making process when it comes to making investment decisions (www.investopedia.com ..., 13 January 2020).

Since there is no centralized system to confirm transactions, users must keep their own records and proof of transactions. If they lose their evidence, they lose their money. If someone with crypto assets dies, their family members cannot access their estate without the deceased's access info.

Roudini (2019) warns that cryptocurrencies have led to the rise of a whole new criminal industry, including unregulated offshore exchanges, paid propagandists, and an army of hucksters. These hucksters win whenever greed trumps common sense. Some of the scams include fake cryptocurrencies and fake ICOs, as described below.

Fake Currencies

These are cryptocurrencies created with the sole intent of scamming people, without being traded on platforms.

OneCoin is a prime example of such a currency. A good 3.6 million people worldwide, among them 14,000 Slovenians, failed to recognize the signs of a scam. Experts say that those signs were clear, and that people with more financial knowledge and awareness were rightly skeptical of OneCoin's offers. Scamming techniques are often quite inventive, making it hard to spot a scam. People bought educational modules from OneCoin and, based on their investment, received a commensurate amount of tokens to mine coins of the same name, only that the coins did not actually exist. In 2016 those behind OneCoin even doubled amounts on investors' fictive accounts, so that they had the impression they were profiting. It later became clear that the money was gone and that investors were unlikely ever to see their money again (<https://siol.net> ..., 27 November 2019).

Xaurum was promoted as a cryptocurrency tied to gold reserves. Experts warned that people could just buy gold instead and that Xaurum was likely to be a scam. This sort of intermediary step is unnecessary, but it sounds good and ends up fooling many people. Investors in Xaurum today have neither gold nor the assurance that they will get their investment back. Furthermore Xaurum was promoted as a cryptocurrency, though it was actually just a token; this makes it impossible to trade as a currency on crypto exchanges.

Big Risks with Crypto Tokens

There have also been many coin or token scams. ICOs or initial coin offerings are a means of financing startups. Despite the huge risks, this type of financing experienced growth for several years (Shepard, 2019).

The principle behind an ICO is that, in exchange for true money (called fiat), investors receive digital tokens or coins that in the future can (or quite often cannot) be used to purchase a particular type of good or service. Experts assess that around 80% of these ICOs are scams (Satis Group, 2018).

It seems that the main reason for launching an ICO is to avoid regulations about securities that would protect investors from fraud. Conventional (non crypto) investments come with an array of legal rights if the receiving company fails to fulfill its obligations or goes bankrupt: the right to dividends, the right to interest on loans, the right to shares of a company's assets, etc. Such rights are enforceable because of the securities issued based on appropriate registration with the competent state institution. Furthermore, parties standing behind legitimate investment transactions must make public exact financial information, business plans, and potential risks. There are also

some limits ensuring that only qualified³ investors can be issued securities for risky investments. There are similarly regulations on the prevention of money laundering and on the identification of parties to transactions, preventing tax fraud, concealment of profits, and other sorts of criminal activity like financial terrorism.

In the Wild West of ICOs, on the other hand, the majority of cryptocurrencies are issued illegally and against regulations, since issuers maintain that they are not, in fact, securities. Thus the majority of ICO investor have no legal rights to exercise. Instead of solid business plans, ICOs usually offer investors a vague “white paper”, a presentation of their supposedly unique concept, and those behind the ICO are often anonymous and untraceable. They thus bypass all regulations on money laundering and identification.

Some countries, e.g. China, even outlawed ICOs, as it was shown that their majority are based on a business model whose point is to cheat investors out of their money. Even if the issuers do have honest intentions, ICOs at best serve as crowdfunding for a startup, few of which ever survive and make it as a business. Studies have shown only 30% of startups to last for longer than 2 years (Investopedia, 2019).

Experts advise against investing in ICOs. Roubini (2018) predicted that soon the launch of ICOs would come to a halt, as enough investors realized the chances of being scammed. That prediction came true the very next year.

Since ICOs became problematic and since the media reported poorly on them, a new method of extorting money was devised, namely the IEO (initial exchange offering). The two are related, as IEOs can be thought of as an upgrade to the ICO. By 2019, investors had become savvy to the scams of ICOs, causing the entire ICO market to plummet by about 97%. Many projects seeking to launch tokens soon began seeking new means of financing to avoid association with any scam. Together with exchanges, the idea was hatched to launch an IEO, presenting it to investors as a new, safer financing option. To generalize, an IEO is actually an ICO backed by a crypto exchange, which ensures that the token can be traded, so that investors assuredly sell their tokens if they so choose. BitMEX is one such platform. Their data show that just around 3% of tokens survived after their ICO, and the statistics for IEOs are no better. Most IEOs end up significantly lower than their launch value (Vidrih, 2019).

All the evidence shows that investing in crypto assets is extremely risky and that providers are constantly seeking new ways to fraud investors.

Conclusions

This article contained a presentation of many financial scams, frauds, and threats that investors should be aware of. Ever since there has been money and savings, criminals have tried their luck at stealing it. Their effort and constant innovation makes it difficult to foresee all scams. Nonetheless, some indicators can be recognized, and it is upon us to stay alert, as our inboxes, social media, and other information channels are regularly inundated with traps. Police statistics show that criminals are very successful, and that their profits are growing every year. Threats exist both to private assets as well as those of the organizations for which we work. It is thus in the interest of everyone to keep informing and educating people about financial literacy and cybersecurity.

³Qualified or well-informed investors are legal entities that somehow work with financial markets (e.g. banks, insurance companies, retirement funds, etc.) and are registered with appropriate state institutions.

References

1. Banka Slovenije (2018). Pojasnilo - kripto imetja niso ne valute in ne denar. Retrieved December 15, 2019, from: <https://www.bsi.si/mediji/1245/pojasnilo-kripto-imetja-niso-ne-valute-in-ne-denar>
2. Bryant, S. (June 25, 2019). How Many Startups Fail And Why? Investopedia. Retrieved December, 19, 2019, from: <https://www.investopedia.com/articles/personal-finance/040915/how-many-startups-fail-and-why.asp>
3. DeLisle, B. (July 17, 2018). SATIS Group Report: '78% of ICOs are Scams'. Retrieved December, 19, 2019 from: <https://cryptoslate.com/satis-group-report-78-of-icos-are-scams/>
4. European Association for Secure Transactions (2019). Don't be a Mule! Money Muling Public Awareness and Prevention. Retrieved December, 19, 2019 from: <https://www.association-secure-transactions.eu/money-muling-public-awareness-prevention/>
5. European Central Bank (2019). Crypto-Assets: Implications for financial stability, monetary policy, and payments and market infrastructures. Occasional Paper Series. 223/2019. Retrieved December, 19, 2019 from: <https://www.ecb.europa.eu/pub/pdf/scpops/ecb.op223~3ce14e986c.en.pdf>
6. Europol (2019). Internet organised crime threat assessment (IOCTA) 2019. Retrieved December 15, 2019, from <https://www.europol.europa.eu/activities-services/main-reports/internet-organised-crime-threat-assessment-iocta-2019>.
7. Europol (2019). Money muling, public awareness and prevention. Retrieved December 19, 2019 from <https://www.europol.europa.eu/activities-services/public-awareness-and-prevention-guides/money-muling>
8. Hasham, S., Joshi, S., Mikkelsen, D. (2019). Financial Crime and Fraud in the Age of Cybersecurity. Retrieved December 19, 2019 from <https://www.mckinsey.com/business-functions/risk/our-insights/financial-crime-and-fraud-in-the-age-of-cybersecurity>
9. Investopedia (n.d.). Behavioral Finance. Retrieved January, 13, 2020 from: <https://www.investopedia.com/terms/b/behavioralfinance.asp>
10. Milivojevič, Z. (February 19, 2009). Kaj je ponzijska shema in kdo so njene žrtve. Časnik finance. Retrieved December 16, 2019, from: <https://www.finance.si/237757/Kaj-je-ponzijska-shema-in-kdo-so-njene-zrtve>
11. OECD (2016). OECD/INFE International Survey of Adult Financial Literacy Competencies. Retrieved November 15, 2019, from: <https://www.oecd.org/daf/fin/financial-education/OECD-INFE-International-Survey-of-Adult-Financial-Literacy-Competencies.pdf>
12. OECD (2017). G20/OECD INFE Report on Adult Financial Literacy in G20 countries. Retrieved November 15, 2019, from: <http://www.oecd.org/daf/fin/financial-education/G20-OECD-INFE-report-adult-financial-literacy-in-G20-countries.pdf>
13. Roubini, Nouriel. (May 10, 2018). Initial Coin Scams. Project Syndicate, Retrieved November 15, 2019, from: <https://www.project-syndicate.org/commentary/ico-cryptocurrency-scams-by-nouriel-roubini-2018-05?barrier=accesspaylog>
14. Roubini, Nouriel. (July 16, 2019). The Great Crypto Heist. Project Syndicate. Retrieved November 15, 2019, from: <https://www.project-syndicate.org/commentary/cryptocurrency-exchanges-are-financial-scams-by-nouriel-roubini-2019-07?barrier=accesspaylog>.

15. Policija, RS, Ministrstvo za notranje zadeve (n.d.). Sedem vrst spletnih finančnih prevar, ki jim uporabniki najpogosteje nasedejo. Retrieved December 19, 2019, from: <https://www.policija.si/svetujemo-ozavescamo/varnost-na-internetu/95864-sedem-vrst-spletnih-financnih-prevar-ki-jim-uporabniki-najpogosteje-nasedejo>
16. Vidrih, M. (December 24, 2019). Iz ICO je preživelih samo 3 % kripto žetonov, pri IEO ne kaže nič drugače. Retrieved January 11, 2020, from: <https://kriptovalute.si/ico-ieo/>
17. Shepherd, M. (2019). ICO Statistics (2019): Funding, Investment, and Best ICOs. Retrieved December 19, 2019, from: <https://www.fundera.com/resources/ico-statistics>
18. Shepherd, M. (2020). ICO Statistics (2020): Funding, Investment, and Best ICOs. Retrieved January 13, 2020, from: <https://www.fundera.com/resources/ico-statistics>
19. Siol, Digisvet (7. 11. 2019). Pravljič je konec: razkrita resnica o kriminalnem imperiju "kriptokraljice". Retrieved December 19, 2019, from: <https://siol.net/digisvet/novice/pravljič-je-konec-resnica-o-kriminalnem-imperiju-kriptokraljice-511233>
20. Urad Republike Slovenije za preprečevanje pranja denarja (n.d.). Preprečevanje pranja denarja. Retrieved December 13, 2019, from: <https://www.gov.si teme/preprecevanje-pranja-denarja/>
21. U.S. Securities and Exchange Commission (2019). Ponzi Schemes. Retrieved December 13, 2019, from: <https://www.sec.gov/fast-answers/answersponzihtm.html>
22. Verizon (2019). 2019 Data Breach Investigations Report. Retrieved December 23, 2019, from: <https://enterprise.verizon.com/resources/reports/2019-data-breach-investigations-report-emea.pdf>

Nevenka Maher

Dr., Associate Professor,
Ljubljana School of Business,
Ljubljana, Slovenia
neva.maher@telemach.net
orcid.org/000-0001-7012-6395

UNLOCK POTENTIAL IN PUBLIC SECTOR AND EMPOWER INNOVATION

Abstract. *In innovation era, innovations are key driver of growth and added value. At the same time in economy based on intangibles is rising inequality in business, in society and in the. World, on macro and micro level. The role of governance and management is increasing, as there are needs to translate innovation⁴ concept in results for better living of people. Monitoring & Analysis of top 2,000-2,500 corporate investors worldwide since 2005 showed, that investments in research and development (R&D) is not enough. New ideas, new products/services (sales revenues) are needed for business and social progress together with high class management (as first, system management and result-based management). Policy⁵ and managers are more and more aware they need to secure the know-how. The paper exposes the fact that innovation is a concept. Innovation concept methodology is recommended and elaborated in EU documents. Dissemination of this information is of special importance in public sector when preparing strategy and measures: governance, public sector administration and public sector management. In the globalisation, the government measures and relevant public management influence economy, jobs, added value, health society, inequality and well-being. The governance and public management role are multiple: international relations, networking, education, training, investment and commercialisation of investments in research and innovation (R&I). The rationale for R&I policy intervention at the EU level is investment in R&I: R&I eco-system, strategic intervention, policies and measures, they all in support the Europe 2020 agenda. Still, governance and public sector awareness are slow in restructuring their mind and action. To come to higher added value, it is multiple and complex task while implementing new challenges as innovation concept as the research, innovation and knowledge costs do not by themselves produce additional added value. In 2017 the European Commission document LAB-FAB-APP⁶ Investing in the European future we want, exposed needed investment in R&I. LAB-FAB-APP Recommendations are about maximising the impact of EU Research & Innovation Programmes and set the scene for a public and political debate on R&I in the Multiannual Financial Framework post-2020 wider audience. Also, the Quadruple Helix Model of innovation recognizes four major actors in the innovation system: science, policy, industry, and society. In keeping with this model, more and more governments are prioritizing greater public involvement in innovation processes.*

Introduction

Innovation is a concept⁷: The promotion of innovation within a country cannot succeed if it is not driven by central players and authorities that can effect nationwide changes. Then innovation is driving competitiveness, growth, new and quality jobs. That is why it is worth to invest in R&I. Key stakeholders who are to build R&I eco-system, design and implement innovation concept are government, public administration, Academia, long life learning institutions, corporation and SMEs.

⁴ »It is to invest in innovation«/.../»Unlocking intangibles brings knowledge«. Thum-Thysen, 2017, pp. 23.

⁵ Mazzucato (2015) in 'The entrepreneurial state' is exposing the need for a state mission and investments without rewards.

⁶ During 2015-2017 I was a member of EU Commissions High Level Group who prepared Report and Eleven recommendations on maximizing the impact of EU Research and Innovation for European future we want. <https://ec.europa.eu>. LAB FAB APP document is based on Interim evaluation of Horizon 2020 and relevant data and analysis of: European Commission documents, Eurostat, Organisation for Economic Co-operation and Development (OECD), European investment bank (EIB), World Intellectual property Organisation (WIPO), etc.

⁷ In LAB-FAB-APP it is mentioned that "Innovation is more than product development" (pp. 3).

Public management must be more result orient. When investing in R&I it is to create sustainable development, also business and commercialisation of innovations. It is to develop knowledge how to identify, measure and value know-how and intangible assets to capitalise. As R&I are key drivers of competitiveness, growth and quality jobs, it is to overcome existing barriers to more investment in intangible assets and better added value results. If not unlocking potential, the gap within equality will continue to be deeper⁸, on micro and macro level, also EU globally is lagging behind.

The process of innovation is three interrelated activities: the generation of ideas; the selection, development and conversion of ideas into commercially viable products or services; and the actual process of diffusion through commercialisation and other dissemination activities. With respect to technological innovation, idea generation often takes the form of scientific research, and idea conversion is often accomplished through technological development.

Innovation is the creation, diffusion and use of new ideas applied in the economy and by its definition refers to »new production processes, new products, new forms of organisation and new markets«. The improvement of product design, manufacturing processes and the establishment of new product lines require firm-level innovation. However, the supporting context of institutions, policies, infrastructure, logistics, technology, culture, communications, marketing, knowledge production, business environment, entrepreneurship, intellectual property protection and information and communication technology connectivity. They all provide a foundation upon which innovation could take place.

Structural features call for a better understanding of industrial dynamics. It is worth to invest in intangibles as in tangible assets, as even statistic data show intangibles bring more added value; they even have spill over effects and long-term impact. But when investing in R&I, economic subjects are to have under control market and investment decisions, funding, etc. It is to promote debate, knowledge, competences and skills among, researches, scholars and practitioners how to leverage intangibles and innovations to create economic and stakeholders' benefit.

LAB-FAB-APP focused the key »must« around designing and implementing innovation concept. As we are preparing to begin new EU financial perspective 2021-2027, there is Agenda 2030 and Sustainable development goals. EU strategies and budget decisions are to be designed and implemented. LAB-FAB-APP guidelines are also simple written for use for every stakeholder.

Methodology

The central aims of the paper were to collect and present several kinds of information which potential is to unlock and then to build further on innovation concept.

The key elements were therefore: Mapping sources and detailed examination of 11 recommendations. Analysis of innovation concept in the context of sustainable development Agenda and Europe 2020. The development of innovation concept when turning from investment in R&D in knowledge-based era to intangible based era and investment in R&I.

Key research questions are: In global competitions, which activities are important, who are stakeholders? Are there any challenges in the types of activities of governance and public

⁸ Coad, A. (2017). Persistent heterogeneity of R&D intensities within sectors: Evidence and policy implications. JRC Working Papers on Corporate R&D and Innovation, No 04/2017, Joint Research Centre, Brussels.

management to support? What are characteristics by which intangible based economy and knowledge based economy and related activities contribute to economic and social development? What are the elements that should be included when managing resources within local and regional strategies? Do they extend beyond the employability, skills and competences of workers, economic growth, innovation, social inclusion? What results and impacts are innovation-based and expected to be delivered?

The prospects for including investing R&I under the regulations for the programming period 2021-2027 are described in LAB report as Recommendations for EU future we want. Eleven recommendation exposed what is crucial when investments in R&I: »Europe can have the most impressive talent pool on earth, but it will fail to capitalise on this if the education system does not foster a more innovative and risk-friendly culture« (LAB-FAB-APP, pp. 13). Together with the difficulties that can arise without investing and understanding what innovation as a concept is which is crucial in terms of its understanding for the Structural Funds, Horizon and other EU source of funding.

The approaches adopted in order to generate the required results largely consisted of the mapping of sources (the literature review and examination of EU policy documents) and analysis of innovation Initiatives. As well as, from EU and the academic experts, information was provided from interviews at EU and national level, In selecting these documents and information care was taken to ensure that they really did outperform clear definition, included clear alignment with Structural Fund objectives, cohesive and compelling orientation, innovation concept sustainability and transferability, as well as effectiveness of R&I investment and managerial efficiency.

The paper is not general information collection and its presentation: it is beginning an 'action analyse' approach about key question about innovation concept as such, how to use EU policy methodology along stakeholders in relevant way in R&I. It is the clear intention of the paper to stimulate initiatives as part of the relevant pursuit of Cohesion policy objectives. It is important for EU countries stakeholders to be empowered to use their know how potential, as »Smart specialisation is probably the single largest attempt ever of an orchestrated, supranational innovation strategy to boost economic growth through diversification, and, as such, deserves to be watched closely« (Asheim, 2018).

EU concept of innovation

R&I as a concept are explained in EU legislation framework and as EU policy. Basic values are put down in Acquis Communautaire, Sustainable Development Goals and in Lisbon Treaty. LAB-FAB-APP is exposing «Innovation is more than technology. EU innovation policy must be based on a definition of innovation that acknowledges and values all forms of new knowledge – technological, but also business model, financing, governance, regulatory and social (LAB-FAB-APP, pp. 12). As innovation brings most added value, potentials for competitiveness, growth and quality jobs are to be understood in the context of investments in development and research, in science and in innovation. A vision and strategic recommendations for R&I are defined in the European Commission document 'LAB-FAB-APP'⁹ investing in the European future we want'. Its

⁹ HLG was invited from European Commission through Carlos Moedas, Commissioner for research, science and innovation to draw up a vision and strategic recommendations for R&I. »We need to continue investing in science, whether disruptive or incremental – LAB. We need to become much better in fabricating added value products and services, converting the results of sciences into innovative solutions that generate value for economy and society – FAB. We need to ensure that these solutions find their application for the benefit of society, and with the more active

eleven recommendations are formulated as a vision for future European Union (EU), to be competitive, to push growth through innovation concept.

Still, it is a lot to be done, as the LAB-FAB-APP exposes that »...in turning knowledge into innovation and growth there is in EU a comparative disadvantage»...“When looking ahead to the future of Europe in a global world, the contrast is striking between Europe’s comparative advantage in producing knowledge and its comparative disadvantage in turning that knowledge into innovation and growth” ... “EU trails well behind many trading partners when it comes to innovation« (LAB-FAB-APP, pp. 7). Turning knowledge and knowhow to intangible assets also include »consistent disciplinarily« as a source of technological and other innovation such as educational, business and social innovation« (LAB-FAB-APP pp. 14).

Recommendations for EU future are focused to innovation concept. It is exposed that it is crucial that investments in R&I and also sending important messages: »Europe can have the most impressive talent pool on earth, but it will fail to capitalise on this if the education system does not foster a more innovative and risk-friendly culture« (LAB-FAB-APP, pp. 13).

Eleven recommendations on EU future we want are:

1. Prioritise research and innovation in EU and national budgets.
2. Build a true EU innovation policy that creates future markets.
3. Educate for the future and invest in people who will make the change.
4. Design the EU R&I programme for greater impact.
5. Adopt a mission-oriented, impact-focused approach to address global challenges
6. Rationalise the EU funding landscape and achieve synergy with structural funds
7. Simplify further.
8. Mobilise and involve citizens.
9. Better align EU and national R&I investment Action.
10. Make international R&I cooperation a trademark of EU research and innovation.
11. Capture and better communicate impact (LAB-FAB-APP, pp. 9-22).

EU policy background to research and innovation

EU policy priorities are defined within EU strategy 2020. Its main objective is growth, quality jobs and sustainable development. EU policy measures focus to competitiveness and stakeholders act to be competitive. European Semester monitors and follows up growth and development by policy measure indicators. Smart specialisation strategy is an EU country precondition to use EU structural funds, all in the context of EU strategy 2020. (The economic rationale for investments in knowledge and R&I is at utmost importance, as EU added value should be increased, also efficiency of managing funding¹⁰, effectiveness of institutions and enterprises and policy measures impact).

There is also Strategy of the commitments of the Innovation Union strategy that seeks to achieve smart, sustainable and inclusive growth in Europe. as well as the achievement and

participation of citizens – APP«, Pascal Lamy, High level group's president, stressed at the public presentation of recommendations (Conference proceedings, 2017, pp. 6).

¹⁰ Also, Horizon 2020 as a Framework Programme was adopted in the context of the Europe 2020. Framework Programmes are the EU’s main instruments for the funding science, research and innovation. In future, it will be Europe Horizon or Framework Programme 9 and its general objective in period 2021-2027 is to contribute to building a society and economy based on knowledge and innovation.

functioning of the European Research Area (ERA). A renewed European Agenda for Research and Innovation is explaining 'R&I as a concept' in detail: "Investing in research and innovation is investing in Europe's future. It helps to compete globally and preserve unique social model. It improves the daily lives of millions of people here in Europe and around the world, helping to solve biggest societal and generational challenges." (Agenda for Research and Innovation, pp. 3). "This reflects the fact that society can only move forward as fast as it innovates. It can only provide lasting prosperity if it makes the most of the knowledge, entrepreneurial spirit and productivity of its people. And it shows that any economy can only stay ahead of the competition if it stays at the frontier of cutting-edge research and innovation." (Agenda for Research and Innovation, pp. 3)

In EU, on macro and micro level, it is expected that new knowledge and key competences are to be developed and to open R&I knowledge to be translated in economic and societal values. Smart specialisation strategy, measures and funding, added value dimensions of research and innovation then mobilise EU potential through national and EU programmes.

Innovation and intangible assets concept development

As resource bases are increasingly composed of knowledge assets, the knowledge-based view characterizes knowledge as the principal source of economic rent. Human capital has its focus on the value that can produce. When it is producing value, it can be sub-classified into the employees 'competence, relationship ability and values. When it is division of added value, it is intangible capital owner rent. »The distinction between explicit and tacit knowledge is vital to consider¹¹«. Explicit knowledge is formal, systematic and easy to express and therefore easy to transfer. Tacit knowledge is generated through own experiences and actions and hard to transfer. The uniqueness and originality of tacit knowledge is the reason, why to invest in development, research and innovation. Knowledge-based society and economy (as EU vision is) - capable of sustainable economic growth with more and better jobs and greater social cohesion brings new challenges: not only to the development of human resources but know how to perform innovation and intangible assets.

Innovation can further perform assets. Among assets, investments in R&I brings more added value from intangible assets as tangibles. That is why it is important to identify, measure and value intangibles to be equity and property under control. It is also to add an important role of management to find adequacy of all existing methods to perceive, institution capacity building and develop innovation-business capacities. Basic management task is to use resources efficiently and perform result¹². Yesterday tangibles assets were important: as servers, platforms. Nowadays intangibles are, as: big-data, analytics capabilities, business models, patents and processes – they can bring income and even multiply income.

Value creation is based on leveraging intangibles, but firms lack knowledge and skills on identifying, measuring and valuing knowledge, know how, innovations and intangibles. It is important performance task - managing human, social and intellectual capital. It is also to develop

¹¹ Knowledge Management and Intellectual Capital: What frameworks from KM and IC are viable to measure competence? Almir Cosic. Conference Take 2019 pp.128.

¹² »Also largely uncounted, intangible digital assets may hold an important key to understanding competition and growth in the Internet era«. In 2013 US Bureau of Economic Analysis in GDP figures categorized research and development as fixed investment and joined software in a new category called intellectual-property products (<https://www.mckinsey.com/industries/high-tech/our-insights/measuring-the-full-impact-of-digital-capital>).

mechanisms as different business environments and firm-specific contingencies impact the relationship between IC and value creation.

Due to this millennium changes, management responsibility is to be close to economic reality and consider innovation concept. It happened during financial perspective 2014-2020 that the results show, that the developed world already moved from knowledge era to intangibles era. Intangibles are found to be vital for productivity and economic growth and can help explain productivity differentials¹³ (across Member States). Intangibles are at the core of what makes firms competitive. »In the EU-15, the contribution of total intangible assets to output growth is between one and three times as high as the contribution from tangible assets. Moreover, closing the gap in investment in intangible assets vis-à-vis the US was found to contribute positively to closing the gap vis-à-vis the US« (Unlocking investment conclusions). That is why it is capacity building of public institutions for identification, measurement and valuing potential of innovation and intangibles. As intangibles can be property (assets in balance sheet), as such they could multiply their value. Each of five big groups of stakeholders: governance, public administration,

Academia, long life learning institutions and SMEs and their management are not only to understand how millennium changes affect potentials but also to produce responsible knowledge and knowhow to assist science, research and innovation. It is awareness to raise, to disseminate knowledge and knowhow and to perform best results. If not unlocking innovation and intangibles potential, the gap within equality will continue to be deeper on micro and macro level.

Challenges for public management and governance

Countries are realizing that competitiveness with other countries, both economically and for its human capital, requires that government ministries or departments need to coordinate their activities for effective and efficient GDP growth. We live in Industry 4.0, in economy based on knowledge and innovation; digital is connected to every product, service and property. European society is driven largely by technological and market innovation. That is why it is important to understand innovation concept and to translate it into practice. It is important to understand the approaches, models and tools for assessing and managing intangible assets to support the renew and the development of new business models aligned with the strategic competitive scenario design.

Traditionally a company's value stemmed from its working capacity while its competitiveness was associated with all the following: its material resources, its ability to procure raw materials at a reasonable cost, the standardisation of its production, a rational division of labour, transport. But »... now this value has increasingly been seen to be based on know-how, while competitiveness is fruit of the company's store of knowledge...« (Unlocking Investment in intangible Assets, pp. 7). Best firms are branding.

The promotion of innovation within a country and investment in R&I cannot succeed if it is not system driven. Central authorities effect nationwide changes by supporting context of institutions, policies, infrastructure, logistics, technology, culture, communications, marketing, knowledge production, business environment, entrepreneurship, intellectual property protection, information and communication technology connectivity - all provide a foundation upon which innovation could take place.

Many transnational firms grew bigger as states are, what can jeopardise resources of budget, its structure and use. Public management is be accountable for effective use of resources to come to

¹³ Trends of investments in intangibles have been rather stable even during the recent crisis.

result as never before. In 4.0 industry, management is not only to speak about human, social or intellectual capital as it is in fact not capital as an economic category. To become an economic category capital entity must be identified as such, measured and valued (this is also put down in accountancy standards). Human capital is contracted by a firm owner, and that is why in capitalism the owner equity become human capital result. Intangible assets as a result – they are a property and influence economic and social relations.¹⁴ To improve understanding, OECD has been doing an impressive work¹⁵.

Global value chains are already an important reality in the world economy. They are characterised by a high fragmentation of the production process, based on a higher level of economic integration, efficient and effective transports, telecommunication and logistic services, and by services playing a more prominent role. The companies that are a part of value chain usually display high levels of innovation, flexibility and productivity. Several international studies have concluded that the participation in global value chains is beneficial for SMEs, in terms of growth and internationalisation. However, many SMEs have difficulties securing access to global value chains, even the EU-based ones, which constitutes a market failure.

How public institutions serve people became important. The innovative responses could be generated with collective efforts from governments, international organizations, private sector, civic society, academia/think tanks, and other partners. Academia is to involve in complexity of activities. Important mission of universities becomes the perspective of technology transfer, market driven innovation and its social engagement. Collaborative R&I projects should include training activities for the next generation of researchers and innovators. The transition from traditional academia to a mission role means transforming universities and higher education providers to be critical players in socio-economic development and regional growth. Important mission of universities becomes the perspective of technology transfer, market driven innovation and its social engagement. Universities and their teaching could assist for quality life-long learning in the context of needs for new knowledge and competences. It to design own *eco-system*, *innovation* strategy, raising awareness of the impact of knowledge and know how, to promote knowledge needed and disseminate information, business model how to add value to products and services.

Public sector is too slow adapting not to jeopardise key values as equality, cohesion and sustainability. Cloud computing, the internet of things, artificial intelligence. Advanced technologies as blockchain, 3D-printing, are expected further dramatically change our life. Digitisation, innovation, research and knowledge, they are all interrelated and impact each other. This is a context in which governance and business is (to be) managed to come to result. But, in EU »...in turning knowledge into innovation and growth there is in EU a comparative disadvantage”...“When looking ahead to the future of Europe in a global world, the contrast is striking between Europe’s comparative advantage in producing knowledge and its comparative disadvantage in turning that knowledge into innovation and growth. It does mean that managing of knowledge into innovation and growth is not effective« (LAB- FAB-APP, pp. 7-8).

¹⁴ Soete, L. (2017) turned attention to openness as driver for an XXI. century mission-oriented research policy.

¹⁵ <https://www.oecd.org/sti/inno/46349020.pdf>

Intangibles based economy (IBE) and knowledge-based economy (KBE)

Westlake and Haskel in their book 'Capitalism without Capital: the rise of the intangible economy' illustrated the value of the firm in knowledge-based economy (KBE) era and in economy based on intangibles (IBE) as equations, as follows:

The value of the firm (in KBE) = Physical capital + a residual (knowhow, processes etc.)

The value of a firm (in IBE) = Physical capital + human capital + social capital + intangibles

Public sector should be more aware of that research and development (R&D) and research and innovation (R&I) are two complex systems, but different ones. Today's firms are looking beyond research and development (R&D) and drive innovation. They invest in a wider range of intangible assets, such as data, software, patents, designs, new organisational processes and firm-specific skills¹⁶. However, the fact is that.../«firms that are not part of a multinational group of companies – often small and young firms – may be placed at a competitive disadvantage in undertaking and exploiting R&D» (OECD¹⁷ 2013, p.2). Due to specific characteristics of intangible assets, there is a risk that investment remains below the social and economic optimum.

Government subsidies and R&D tax incentives are important instruments in supporting corporate R&D, but due to a large deficit of R&D funding, it is necessary for the state to expand innovation policy tools beyond the traditional ones¹⁸ and to become not just a market fixer but a market shaper (Mazzucato, 2013). Financial constraints to firm's R&D investments and the role of the active innovation policy R&D has several characteristics that make it different from other types of corporate investments. These include high level of uncertainty as it comes to R&D output, asymmetric information problems between the financial providers and firms performing R&D, being embedded in human capital, offering low collateral to possible lenders. Raising external capital for innovative investments is difficult and the problem is only partly mitigated by venture capital. Financial constraints are more pronounced in the emerging and developing economies due to the underdevelopment of financial sector and weak level of intellectual property protection, which implies a crucial role of the state policy making to prevent this.

It is to turn attention that research and development (R&D) and research and innovation (R&I) are two complex systems, each with their important specifics. In R&D there is analytical science based know why (Asheim, 2018), while in R&I there is technical know-how (synthetic engineering based) and marketing know-how. In global competition marketing know how (through symbols – branding and design creating desires, markets, suppliers, etc.) is crucial to increase added value. R&D is research and development investment in science, mostly in universities and public agencies. Data show that their communication and ties with industry could be better, also more spin-offs can be created. Further commercialisation in R&D is differently understood in era of R&D as it must be in R&I. When R&I, there is strategic marketing and system management what is much more than commercialisation. Corporations build first marketing capabilities and specialise in a diversified way compared. In IBE half of value of investments is in branding. The market for patents and licensing agreements differs from market for computerized information and economic competences. Important value in R&D are citations and intellectual property rights. R&D is a

¹⁶ Blockchain is a decentralized cryptographic technology that enables storing of information in a tamper-proof and irrevocable manner.

¹⁷ In 1999, OECD, the Organisation for Economic Co-operation and Development, convened an international symposium in Amsterdam to deliberate on the experience, issues and prospects on measuring and reporting intellectual capital. At the same time a number of European Institutions were collaborating to produce a common framework for the identification, measurement and control of intangibles as well as to suggest criteria for the disclosure of information on the intangible determinants of the firm's value. This activity, known as the Meritum Project, produced a report within Framework Programme financed by DG Research in April 2001.

¹⁸ Take Conference 2019, Book of abstracts, Grabińska. B., pp. 89-90.

knowledge production, R&D output is typically codified. Expectations from R&I are broader: economic and social wellbeing. R&I are ideas or creation or innovation, know how, embodied in people. As R&I is tacit knowledge, for R&I potential can be demand by different agents.

While in KBE resources are intellectual capital (human capital, structural and customer capital), in economy based on intangibles, brands, information technology systems, databases etc. are performed into intangible assets as platforms, business models, etc. and they function as property and resource. That is why managing system is needed and performance to be under control. While investing in R&D there can be leadership, while when investing in R&I there must be top19 managing of strategy, performance, result based management, marketing management, innovation management, human resource management and management accounting.

Intangibles capitalisation is bringing added value for growth, employment and sustainable development, relationship between intangible capital investment and labour productivity growth is to be under control. »Roth and Thum (2013) confirmed a positive and significant relationship between intangible capital investment and labour productivity growth. Sectoral comparisons of the productivity effects of intangibles, Niebel et al. (2013) identified the manufacturing and the finance sector as the sectors in which intangibles are the most productive in Europe. Chen et al. (2016) found that ICT-intensive industries are those benefitting most from intangibles in Europe« (Thum-Thysen 2017, p. 17). Not to recognise symptoms of intangibles-based society and to act, it means degradation, lower added value even bankruptcy, market and social exclusion, workers to expire and continue with precarious work.

Conclusions

The increasing complexity and speed of innovation development offer opportunities and pose challenges not only to innovation actors at all stages of the technological development, but also to management²⁰ of all key sectors of managing business and marketing. In industry 4.0, innovation concept is the creation, selling, marketing and using of new ideas and products. Concept acknowledges and values all forms of new knowledge – technological, but also business model, financing, governance, regulatory and social – which help generating value for the economy and society. That is why it is to drive systemic transformation.

Key stakeholders, as governance, public administration, Academia, long life learning institutions public research institutions are to understand how millennium changes affect their know-how, how to design and implement potential of innovation while producing added value. That is why it is important the role of management and he is to unlock potential as digitisation drives social-economic sustainable development quicker and intense global competition, also public management must be more result based and understand that knowledge and know how can create intangibles as property. It is important move from cost thinking towards real investment in R&I to come to added value.

¹⁹ Moncada-Paterno-Castelo (2015): »...in the new technological landscape, the sources of invention (discovery of new potential output) and innovation (production and commercialisation of new products and services) are not necessary located in the same country, new technologies (e.g. in ICTs) find applications in multiple sectors, and no single country or company can dominate the full value chain. In this 'multipolar paradigm' demand is expanding in large emerging economies which provide the location of production, innovation, branding and other activities«/.../« In this framework what really matters for growth and competitiveness is not increasing specialisation itself, but the ability to exploit areas of technological opportunity«.

²⁰ Asheim is exposing supportive versus competitive relationships that »when discussing how smart specialisation strategy can promote new path development it is important to avoid competitive relationships, where different path developments compete over scarce resources, and to promote supportive relationships providing opportunities for path coupling through expanding the opportunity space for sourcing capabilities and resources«/.../«This will require adaptation of organisational and institutional support structures to allow for new types of entrepreneurship and governance to meet these more long-term development goals and to promote supportive relationships between different path developments« « (Asheim, 2018).

The EU should encourage new market opportunities for innovative goods and services. It should also stimulate synergies investment in research and innovation bringing mutual benefits to people and businesses, however Europe is experiencing an innovation deficit. This is not down to a lack of ideas or initial start-ups: the problem is rather a lack of scale-up and diffusion, with innovations not always being translated into new market and growth opportunities. Industry investment in research and innovation has to step up.

Economy is different when investing in R&D and investing in R&I. Economic differences also differently affect economic subjects. Economic subjects must be aware of them and implement not only science and technology competences, but also governance, managerial, marketing and entrepreneurial know how and know what. The supporting context of institutions, policies, infrastructure, logistics, technology, culture, communications, marketing, knowledge production, business environment, entrepreneurship, intellectual property protection, information and communication technology connectivity. Managers and politicians are to decide whether and how to identify, measure and value intangibles and to promote debate among researches, science, scholars and practitioners how to leverage know how. When investing in R&I, economic subjects are to have under control system and efficient management, market and investment decisions, funding, etc. Economic subjects are to be aware of barriers and drivers and when prepare strategy and marketing concept to maximize results of investment. As there are multiple problems, and unexpected complications in business and in policy career, people are afraid of millennium changes to take responsibility. Stakeholders as people try to minimize problems through their action.

When there is investing in R&I, there must be also strategic management and managing of multiple marketing mix. This complex system of needed actions is very difficult to understand as there is also needed action in physical and in virtual world, first through symbols as branding is. It is to focus on innovation systematic approach, managing system, results and intangibles as result most important property in XXI. century.

References

1. Asheim, B.T. (2018). The role of Smart Specialisation in driving long-term structural changes, SMARTER Conference on Smart Specialisation and territorial Development, Seville, 26-28 September 2018, ppt 2)
2. Brennan, L., Rakhmatulinnin R. (2015). Global Value Chains and Smart Specialisation Strategy; Thematic Work on the understanding of Global Value Chanins and other Analysis within the context of Smart Specialisation, EC.
3. Caratti, G. (2016). Evaluation of intangibles and novel technologies: art or science? TTO-CIRCLE Best Practice Workshop, Brussels, 2016, European Commission, JRC, Head of Unit. Intellectual Property and Technology Transfer, ppt 5
4. Coad, A. (2017). Persistent heterogeneity of R&D intensities within sectors: Evidence and policy implications. JRC Working Papers on Corporate R&D and Innovation, No 04/2017, Brussels.
5. Corrado, C., Haskel J., Jona-Lasinio, C. and Iommi, M. (2016). Intangible investment in the EU and the US before and since the Great Recession and its contribution to productivity growth, EIB Working Papers 2016/08, European Investment Bank, Luxemburg.
6. Egert, B. (2017). Regulation, institutions and aggregate investment: new evidence from OECD countries, CESifo Working Paper No. 6415.
7. European Commission (2007). Measuring structural funds employment effects. Working document no. 6, Brussels.

8. European Commission (2013). Flash Eurobarometer 369. Investing in Intangibles: Economic assets and Innovation. Drivers for growth, Brussels.
9. European Commission (2016). Science, Research and Innovation performance of the EU. A contribution to the Open Innovation, Open Science, Open to the World agenda, Brussels.
10. European Commission (2017). Conference Research & Innovation Shaping our future, Conference proceedings 3 July 2017, Brussels,
11. European Commission (2017). LAB-FAB-APP Investing in the European future we want Report of the independent High-level Group on maximizing the impact of EU Research & Innovation Programmes, Brussels.
12. European Commission (2017). The economic rationale for public R&I funding and its impact, Research and Innovation Policy Brief Series. Brussels.
13. European Commission (2019). Intangible value creation through design — EU Industry Days, BEDA conference 5 Feb 2019
14. European Commission, (2017). Innovation and industrial dynamics: challenges for the next decade, Joint Research Centre, CONCORDE, European conference on corporate R&D and innovation 6 th conference, Seville.
15. European Commission, (2018). Communication. A renewed European Agenda for Research and Innovation - Europe's chance to shape its future, Brussels.
16. European Investment Bank (2016). The Third Pillar at Ground-level: Case studies and other evidence related to investment barriers under the third pillar of the Investment Plan for Europe. [http://www.eib.org/attachments/thematic/breaking down investment barriers en.pdf](http://www.eib.org/attachments/thematic/breaking%20down%20investment%20barriers%20en.pdf)
17. Global Intangible Finance Tracker (2017). An annual review of the world's Intangible value.
18. Lisbon Agenda (2000). European Council Conclusions, Brussels.
19. Moncada-Paterno-Castelo, P. (2015). In Sectors dynamics and demographics of top R&D firms in the global economy (JRC Working papers on Corporate R&D and Innovation No 06/2016.
20. OECD (2013). New Sources of Growth: Knowledge-Based Capital – Synthesis Report. Paris.
21. OECD (2013). Supporting Investment in Knowledge Capital, Growth and Innovation, OECD Publishing, Paris. <http://dx.doi.org/10.1787/9789264193307>(got January 13, 2018).
22. OECD Science, Technology and Innovation Outlook 2016
23. On intangible investments for competitiveness: micro-macro evidences (2017). Industrial Research and Innovation Monitoring and Analysis; 9th IRIMA workshop Report, Brussels.
24. Soete, L. (2017). Openness as driver for a 21st Century mission-oriented research policy. Speech presented at the 6th CONCORD Conference, Seville. <http://iri.jrc.ec.europa.eu>
25. Staff Working Document for Horizon 2020 Interim Evaluation (2017). European Commission Got at: https://ec.europa.eu/research/evaluations/index_en.cfm?pg=h2020evaluation.
26. Take (2019). Book of conference abstracts Poznan 2019
27. Thum-Thysen, A., P. Voigt, B. Bilbao-Osorio, C. Maier, D. Ognyanova (2017). Unlocking investment in intangible assets in Europe, Quarterly Report of the Euro Area 16(1), 23-35.
28. Thum-Thysen, A., Voigt, P., Bilbao-Osorio, B., Maier, C., Ognyanova, D. (2017). Unlocking Investment in Intangible Assets. European Economy Discussion Papers Directorate-General for Economic and Financial Affairs, Growth and Structural Reforms, Brussels.
29. Westlake, S., Haskel, J. (2017). Capitalism Without Capital: the rise of the intangible economy. New York.
30. WIPO, The World Intellectual Property Report 2017. <http://www.wipo.int>.

Tetiana Gavrillo

Ph.D. in Economics, Associate Professor,

National Aviation University,

Kyiv, Ukraine

orcid.org/0000-0002-2010-307X

**FINANCIAL INCLUSION AS A CONDITION OF SUCCESSFUL DEVELOPMENT
OF THE UKRAINIAN SOCIETY**

Abstract. *The article deals with the essence of financial inclusion as a condition for the economic growth and improvement of welfare level of Ukrainian citizens. The national legislative framework that regulates the processes of financial inclusion development is analyzed. The status of financial inclusion in Ukraine is investigated and the factors that will contribute to the inclusion of the Ukrainian population in the financial system are identified. The peculiarities of using payment systems in Ukraine, the convenience and safety of their use, which are one of the effective tools for increasing the level of financial accessibility as well as the conditions for the development of the cashless economy are identified. Given the high level of openness of Ukrainians to innovation, the necessity to apply innovative technological solutions by introducing new financial services and improving access to existing ones is substantiated. A study has been conducted on the relationship between financial inclusion and financial literacy which enables consumers make an informed choice about a product or service. The conditions for raising the level of financial literacy of both the population and domestic entrepreneurs have been determined by applying a comprehensive system of measures designed for the long term.*

Introduction

Financial inclusion involves the possibility of access by individuals and legal entities to financial products and services that are able to meet their needs and are provided with a high degree of responsibility and sustainability. Financial affordability is primarily understood as the availability and equality of opportunity to obtain financial services. According to the OECD / INFE, financial inclusion should be analyzed as a process characterized by the ability of all segments of the population to use a large range of financial products and services, and this opportunity should be created through the use of existing and innovative approaches based on increasing financial literacy and education. Financial innovations are intended to facilitate the emergence of the need to acquire knowledge, the formation of new skills and practical experience, change the ways of making financial decisions.

The development of modern economies demonstrates the growing role of financial inclusion as an indispensable condition for economic growth and an important factor in ensuring conditions for social equality. According to the recent research more than a third of Ukrainian consumers are not included into the financial system, which causes a low level of their involvement in the development of economic processes in the country, lack of rational use of available financial assets, a high level of implementation of possible financial threats. Increasing the level of financial inclusion enables to create conditions for the development of the non-cash economy by attracting broad segments of population to the financial system. It will be accompanied by processes of its diversification, increase of investments in the economic sphere from consumers of financial services and will result in increasing the level of satisfaction of stakeholders interests, financial regulators, including services and the state as a whole.

Interest in increasing the level of financial inclusion is demonstrated by a number of international organizations, which consider the solution of this problem as one of the key tasks of their functioning. The World Bank has found that financial inclusion is the focus of governments in many countries. It is proved by the presence of a national financial inclusion strategy or the presence of issues on its growth in the overall national strategy in more than one hundred countries.

The purpose of this study is to assess the condition of financial inclusion in Ukraine and determine the factors which will help to increase the level of ensuring both the financial well-being of our citizens as well as the development of the domestic financial system, taking into account the existing world experience.

1. Legislative regulation of financial inclusion in Ukraine

Ukraine has approved the Financial Sector Development Strategy for 2025, which identifies five strategic areas, such as financial stability, macroeconomic development, financial inclusion, financial market development, innovative development. The priority in the area of financial inclusion is the development and implementation of the Financial Inclusion Strategy. Important factors that will contribute to the development of financial inclusion processes are: strengthening of regulatory action to ensure the required level of efficiency and security of electronic payments, digitizing these processes, providing conditions to facilitate access to financial services for consumers in remote areas and those belonging to the category of persons with special needs.

A number of measures should be provided to protect users of financial services. First of all, it concerns timely provision of information on the guaranteed amount of deposits to banking institutions, payment of services of banks and non-banking financial institutions, informing the institutions about the terms of the agreement before its conclusion. What is important is the intention to form an independent dispute settlement mechanism.

A significant step will be the implementation of a number of steps in the area of increasing the level of financial literacy of the population, which involves improving the level of awareness of financial services consumers by creation of a special site, the implementation of a number of programs and educational activities covering various segments of the population, as well as targeted at regional small and medium-sized enterprises [1].

Features of the new Strategy are to focus on meeting the interests of all participants in the ecosystem: users of financial services and key players who produce these services. Banks, insurance companies, investment firms, venture and retirement funds, payment institutions, postal operators, government social services are considered as providers of financial services. The functions of regulation and control are vested to the following entities of the ecosystem: Verkhovna Rada Committee, National Securities and Stock Market Committee, National Commission for State Regulation in Financial Services Markets, Ministry of Finance, Ministry of Economic Development, National Bank of Ukraine, The State Fiscal Service, the Deposit Guarantee Fund and the President of Ukraine.

Infrastructures and technologies allocated to one of the financial ecosystem groups include payment systems, payment infrastructure service providers, cash collection / processing / storage services, data centers, cryptocurrency issuers, cryptocurrency exchanges, innovation hubs, stock exchanges, merchants and so on. Subjects capable of conducting expertise in financial sector processes include market scientists and experts, business associations, industry associations, the international professional community, international donors, consulting companies, media, educational institutions [2].

Analyzing the Strategy Roadmap, it is necessary to note that the main changes to be made will increase the level of financial inclusion and will touch financial online services first of all, improving mortgage availability and security of consumers, increasing the protection of rights of financial services users. It is important that by the end of this year it is necessary to approve the QR code for the transfer of funds and to create conditions for improving the level of reliability of financial services advertising.

In the summer of 2019 the National Bank of Ukraine established the agency for protection of rights of financial services users. It allowed to reveal a number of problems consumers complained on. They are: the banks' silence on the real value of the loan; the use of wages or other charges to pay debts without the knowledge of the funds owners; raising the credit limit at a higher interest rate without providing information on the legal basis of the actions taken. Given the mass of complaints (an average of 900 complaints each month from individuals and businesses), by the end of 2021, it is planned to make it mandatory for all financial institutions, both banking and non-banking, to provide clients with comprehensive information on the actual costs in case of obtaining specific financial services.

Starting on June 2, 2020, complete information on all the features of the banking institutions' relationships with consumers, including cost aspects, obligations of both parties and liability in case of breach of these obligations are to be posted on the banks' websites. Within the same timeframe, banks should start posting calculators on their websites that will allow to estimate accurately the amount or cost of financial services; at the same time, the Financial Services Consumer Protection Office will constantly monitor websites and banking advertising products for the accuracy and transparency of the information provided.

The draft law "On Amendments to Certain Laws of Ukraine on Attracting Postal Operators to Provide Financial Services" is promising, whereby postal operators will be able to provide financial services. This will increase the level of financial inclusion of the population by creating conditions for improving access to financial services in all regions of the country, improving the situation with cashless payments, expanding the client base of banking institutions and postal operators [3].

The bill envisages innovations in the relationship between banks and postal operators, enabling the banking institutions to grant the latter the right, based on agency conditions, to provide certain banking services - to attract funds (as deposits) and precious metals both to the public and business structures; open and maintain current (correspondent) accounts of consumers, which will also apply to banking metals. Postal operators will be given the right to issue electronic payment facilities to customers and to perform certain banking functions on their behalf that are provided for electronic payment issuers. The decision to enable postal operators to identify and verify users is important.

As current financial services market needs to improve regulatory action, which, first of all, concerns non-banking financial services, it is logical to adopt a "Split law" that provides for the transition of a number of non-banking institutions (insurance and leasing companies, credit unions, pawnshops, financial companies) under the regulation of the NBU [4]. According to the NBU representatives, this law will create all conditions for reforming the non-banking financial sector by introducing an integrated model of regulation rather than a sectoral one and will ensure the formation of rational market behavior of consumers. The emergence of the Law is linked to the need to improve the domestic financial system in accordance with international standards and will be accompanied, as stated, with the technical assistance from international financial institutions.

The opinions of experts on the effectiveness of this Law do not have unanimity. First of all, there are fears about the threat of enlargement of the non-banking market and, as a result, the loss of jobs, reduction of tax refunds, the possibility of increasing the price of financial services. Taking into account the number of consumers in this segment of the financial market has reached 20 million today, there is an obvious need for further improvement of regulatory measures, taking into account the proposals from all subjects of market relations.

An important step to increase the level of financial inclusion is the draft law on payment services submitted by the NBU at the end of January 2020, which, in the NBU's opinion, creates the opportunity for the process of updating the payment market. The implementation of innovations provided by this document should ensure the expansion of the quantity and quality of financial products and services by increasing competition between banking and non-banking financial institutions. There will be an increase in the number of payment services available to market participants in the sphere of transfers, to nine (seven financial and two non-financial). The opportunities for non-bank financial institutions to open payment accounts, issue payment cards and electronic money, and provide acquiring services will be significantly expanded.

One of the major innovations is the removal of restrictions on the use of payment systems, as well as the elimination of the mandatory participation of banks or non-banking financial institutions in the payment system in order to provide transfer services. The decision to introduce Open Banking allows banks and other entities providing payment services with open access to their customer information, subject to their consent, to other market players is extremely promising. Given the possibility of new threats to information security, attention is being paid to the implementation of special security measures for the operations carried out.

Open Banking implementation, based on the formation of a modern payment market architecture using the international standards of ISO 20022, subject to perfect completion of a holistic mechanism, can create a truly innovative payment landscape.

2. The state of financial inclusion in Ukraine

Domestic consumers are characterized by an inadequate level of use of financial products - 60%; The number of consumers with accounts in financial institutions is significantly lower than in countries such as Poland, Belarus, the Czech Republic, although it is ahead of Romania and Georgia (Fig. 1). Comparing the number of regular users of Internet and mobile banking in Ukraine with other countries shows that this indicator is significantly lower in our country (7-8 times less than, for example, in Poland and the USA).

The overwhelming number of transactions in banks of Ukraine is carried out in cash, unlike in the above countries, where the remote payment and transfer method (about 95%) is substantially predominant. As the experience of foreign countries shows, citizens' participation in convenient and secure payment systems is a powerful tool for increasing the level of financial accessibility. About two billion are the number of people around the world who use cash to make payments, and it is clear that they are minimally involved in the financial ecosystem, face more risks and incur additional costs. For example, the use of funds transfer systems creates the ability to conduct transactions with funds in a short period of time in any region of Ukraine and abroad.

According to the NBU, the volume of transfers within Ukraine in 2019, not including transfers via banks, card payment systems, post offices and informal channels, amounted to 197.93 billion UAH or 7679 million USD (74% of the total amount of funds transferred). Funds transferred to Ukraine from other countries amounted to USD 2271 million (22% of the total amount), from Ukraine - USD 398 million (4%).

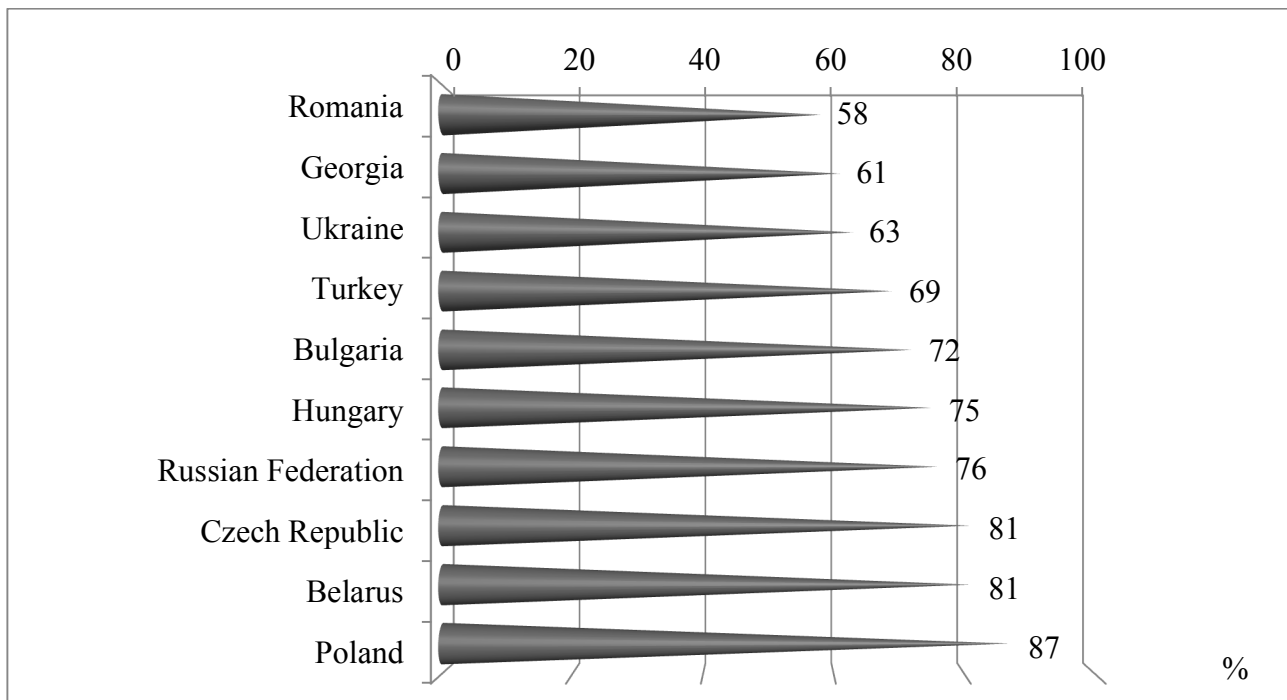

Fig. 1. Number of consumers holding accounts in financial institutions, %

Source: Created by the author [5].

Consumers have used 39 funds transfer systems, of which 31 are systems created by residents and 8 systems by non-residents. Among the funds transfer systems created by non-residents, four systems are related to the USA, others - to Georgia, Canada, Azerbaijan. The countries from which the funds were transferred were in the following order: in the first place - the USA (18%), second place belongs to Israel - 14%, in the third place - Italy (9%), Poland and the Russian Federation - 7% each; the other 219 countries make up 45%. With the use of transfer systems, the largest amount of funds came from Ukraine to Russia - 31%, Georgia - 11%, Azerbaijan - 6%, China and Uzbekistan - 5%, and other 195 countries - 42% [6].

A positive trend is the increase in the share of non-cash payments made by the population of Ukraine through payment cards. Based on NBU information, the number of payment card transactions issued by Ukrainian banks, including cash and non-cash transactions, amounted to 5057.3 million in 2019, amounting to 3576.7 billion UAH. Non-cash transactions increased to 50.3% in 2019 and amounted to UAH 1798.3 billion (in 2018 this figure was 45.1%, in 2017 –39%, in 2016 and 2015 - 35% and 31%, respectively). Non-cash transactions in 2019 accounted for the bulk of the total volume of operations - 4167.1 million, or 82.4% (in 2018 - 78%, in 2017 - 75%, in 2016 and 2015, respectively 71 % and 65%), which means that eight out of ten operations performed are cashless operations [7].

The largest number of transactions were conducted using payment terminals - 2133,2 mln. (51%), transactions on payment for goods/services on the Internet amounted to 727.9 million (18%), transfers of funds from the card to a bank account on the Internet - 766.6 million (18%), transfers from card to card - 473,8 (11%), operations in self-service devices - 65,6 (2%).

In monetary terms, non-cash transactions amounted to UAH 1798.3 billion, which corresponds to 50.3% of the total value of payment card transactions. Transfers from card to card were the most significant in value - 762.6 billion UAH (42%); payments using payment terminals occupy the second place - 513.4 billion UAH (29%); transactions for payment for goods / services

on the Internet - UAH 337.2 billion (19%); transfers of funds from card to bank account on the Internet - UAH 152.4 billion (8%); operations in self-service devices - 32.7 billion UAH (2%) [8].

Recently, there has been a rather intense increase in the number of payment cards used by the population. In 2019 this figure has increased by 16% and reached the level of 68.9 million. The distribution of the number of cards depending on the payment system indicates the largest increase of Mastercard payment cards - by 68.5% per year, at the end of the year their number reached 47.2 million; the number of Visa payment cards increased by 30.5% in the previous year and reached 21 million; "Prostir" payment system - by 1% and amounted to 0.6%.

The fact that 61.2% of all payment cards are active deserves attention. The volume of contactless payments is increasing with the use of both contactless payments and the use of smartphones. The previous year, the number of contactless payment cards in operation increased more than twice - up to 8.6 million cards (in 2018 this figure was 3.9 million); the number of tokenized payment cards at the beginning of this year amounted to 2.5 mln. Thus, more than a quarter of all payment cards (26.5%) are contactless and tokenized cards [9].

One of the peculiarities of the development of the domestic payment market is the increase of the payment infrastructure, mostly contactless, as evidenced by the increase in the number of commercial POS-terminals (19.7% - growth rate in 2019); at present 90.4% of POS terminals account for 79.4% of contactless payments. In 2019, the number of economic entities accepting payment cards increased by 15.1% and reached 240.2 thousand. At the same time, the number of ATMs decreased by 2.2% and amounted to 19.5 thousand, among which deposit ATMs make up 9.3%.

The total number of payment terminals (per 1 million population) shows a steady upward trend: 5.2 thousand in 2016, 6 thousand in 2017, 7.1 thousand in 2018, 8.4 thousand in 2019. However, the problem of having terminals is best solved in Kyiv, Dnipro and Kharkiv regions, and the worst situation is observed in Luhansk and Donetsk regions [10].

The number of terminals for banking service per thousand people in Ukraine is six, in Kyiv this figure reaches 16, in Ternopil and Transcarpathian regions - 3; in Poland, the number of such terminals is 12.5 per thousand people even in rural areas, and in the UK more than 50.

Ukrainian fintech company EasyPay found that payment terminals are primarily used to pay for domestic services - mobile communications, the Internet, replenishment of bank cards. In terms of the number of transactions made at EasyPay non-banking terminals and other operators, the first place is taken by mobile communication (30%), the second place is the payment for using the Internet and replenishment of bank cards - by 25%, payment for the use of television and utilities is 12% and 8% respectively.

There is a difference in the list of services used by domestic consumers depending on their territorial affiliation. In the Kyiv region, citizens mostly replenish cards, pay for mobile communications and bank loans. The citizens of Odessa region pay for mobile communication and Internet services, as well as replenish cards. In the Lviv region, consumers mostly replenish cards, pay for mobile communications and utilities.

The most active users of non-banking terminals are the target audience aged 26-35 years (39% of the total population), living in cities with a population of more than 100 thousand people, regional and district centers. The use of non-banking terminals is common or frequent enough for 32.9% of Ukrainians; the proportion of users who refer to this type of service is 45%; of those who do it only sometimes - 12%.

As noted above, the Ukrainian market is dominated by payment systems of two companies - Mastercard and Visa, and the consumer has a legitimate question as to which of them to prefer. When it comes to Ukraine, the user does not make a significant difference, unlike when traveling abroad. Let's compare the features and key performance indicators of these companies (Table 1).

Table 1. Comparison of Mastercard and Visa companies

№	Feature (indicator)	Mastercard	Visa
1.	Countries where it is advisable to use payment cards because of the main currency of the payment system (Mastercard - dollar and euro, Visa - US dollar)	Ukraine, CIS, Europe, Africa	Ukraine, CIS, USA, Canada, Australia, South -Eastern Asia and Latin America
2.	Number of countries in which cards are accepted for payment	210	200
3.	Number of cards in the world,%	16	29
4.	Number of connected outlets in the countries of the world, mln. pieces	30	20
5.	Payment volume, billion USD	1,652	2,978
6.	Revenue growth rate (per year),%	15	13
7.	Growth in operating profit (per year),%	16	14
8.	Non-GAAP operating margin,%	59,4	66,9
9.	Dividend yield,%	0,5	0,6
10.	R/E ratio (share price to earnings per share)	48,2	38,84
11.	Forward coefficient P/E	35,9	33,34
12.	Estimated earnings per share growth,%	17,69	16,36

Source: compiled by the author [11,12].

Visa and Mastercard are US-based payment systems that were created at the same time and began to dominate the global market. Existing different interpretations of the origin of these two systems are related to differences in the base currency of transactions: Mastercard is dollar and euro, Visa is US dollar. In case when cards are used with an account in a currency other than the currency of the country where the payment transaction takes place, one or more conversions are made, accompanied by the corresponding costs. An example is the use of a Visa card with a dollar account in Europe or the United States: when making a payment account in Europe, a fee is charged for converting dollars into euros, unlike the US, where, due to lack of conversion, additional costs won't follow.

When traveling to foreign countries it is necessary to know in the differences of various cards - electronic, standard and premium class. Electronic cards can be used to obtain funds or to pay for goods or services; at the same time, they have limited ability to make online purchases. These cards include Visa Electron, Maestro and Mastercard Electronic. They are considered to be lower in class, as these cards do not have a high level of security, and can be compromised at a foreign ATM or point of sale. This means that cards of this type can be copied and threatened with unauthorized withdrawals.

Standard cards (Visa Classic, Business and Mastercard Standart) allow you to pay at terminals, withdraw cash, pay online. When using a Visa card the code CVV2 is used, the Mastercard is CVC2. Premium Class Cards (Visa Gold / Platinum, Mastercard Gold / Platinum) provide additional services such as car rental discounts, free insurance, special discount offers.

Along with international payment systems there are also national payment systems in many countries of the world that allow states to ensure independent autonomous functioning as well as to increase the level of national payment security (Table 2).

Table 2. Features of national payment systems

№	Country	Payment system	Features of the payment system
1.	Ukraine	Prostir	It provides retail payments through the use of Prostir payment cards. It allows you to pay for the purchase of goods or services rendered, receive cash, etc.
2.	Sweden	Klarna	Various payment solutions, such as one-click online shopping. The TranzAxis platform allows the Swedish payment application to use its own designs to launch new services as well as support existing services
3.	France	Carte Bleue	It allows for transactions without authorization from the cardholder's bank; contains voice-based authentication systems that secure online trading; integrated into a broader scheme called Cartes Bancaires
4.	Holland	iDeal	It provides real-time banking services, use of a customer's online account, ability to manage an account using a mobile phone, transfer funds from a bank, deposit methods
5.	China	Alipay	It is a part of Alibaba Group, the largest Chinese e-commerce company. It was created specifically for the ability to pay bills on popular AliExpress.com and Alibaba.com sites. To protect its subscribers, a whole algorithm of actions was developed. Each registered user is guaranteed security and protection against loss of funds
6.	Japan	JCB	It became Asia's first international payment system; which develops a card-acceptance network worldwide, collaborates with market leaders and maintains partnerships with sales and service businesses. Cardholders can benefit from a variety of benefits and incentives: from discounts and bonuses in stores to concierge services
7.	India	RuPay	More than half of debit and credit cards transfer funds through the RuPay payment system; a feature of the cards is the presence of microprocessors, so that transactions on the network have a high degree of security
8.	Latin America	DineroMail	Payment platform for transferring funds to a NETELLER account; it provides money replenishment, bank transfers, transfers via internet banking and transfers of balances from the previous DineroMail account

Source: Compiled by the author [13].

The further functioning of payment systems in Ukraine is related to the development of the cashless payment market, and this is primarily aimed at Visa and Mastercard, which declare their intention to increase this type of transactions. From April 2019, all new Visa cards are contactless, Mastercard plans to do so from April 2021. Visa will create conditions for refusal of magnetic stripe cards by reducing the interchange of transactions with such cards to cut the interest of banks in their service. Another measure that will facilitate the transition to contactless cards is payment without entering a PIN.

The increase in contactless payments from smartphones and other gadgets is expected. For this purpose representatives of both payment systems are developing appropriate software that will allow smartphones to become payment terminals. Online payments are also being innovated: 3D Secure 2.0 will be introduced to replace 3D Secure's online payment verification system, and this applies to both payment systems, based on selective identification of transactions that do not correspond to the user's usual method of action. Mastercard will use Mastercard ID check in Ukraine, which will allow for behavioral biometric identification of the user (not only fingerprints, face and retina scans, but also the nature of human behavior in the process of contacting their smartphone - a way of interaction, speed of character selection during typing text, etc.).

3. Financial literacy and financial inclusion

At the Second International Forum on Financial Inclusion, held on June 12, 2019, attended by more than three hundred representatives of state, banking, educational, business structures, payment systems, experts the continuity of financial inclusion processes with further development of financial literacy was emphasized. Financial literacy involves the consumer's ability to make an informed choice of a product or service, assessing and understanding their advantages and the risks that may arise while in use. In accordance with the OECD methodology for calculating the overall financial literacy index, Ukraine received 11.6 points out of 21 in 2018, on par with Poland in 2016, which ranked lowest among the thirty countries in which financial literacy was assessed. The average financial literacy index for 2016 in all countries surveyed was 13.2, for the six Ukraine neighboring countries with low and middle income - 12.1. Assessment of the level of financial literacy was made on three components: "knowledge", "attitude", "behavior".

The gender and territorial distribution of the population have a minor impact on the size of the overall financial literacy index. This indicator depends on the size of income and education received to a greater extent. The component "knowledge" is the worst represented in young people from 18 to 24 years, but it increases with the growth of income, as well as the component "behavior". The "attitude" assessment revealed the independence of this component from the level of income. The study of financial knowledge revealed that only 43% of the adult population understand the financial issues correctly (56% for all countries participating in the project in 2016, 51% for neighboring countries). Nonetheless, there is interest in raising both their own financial literacy and their children's financial literacy in managing their own funds.

Only 33% of the Ukrainian population care about their future and 18% consider it necessary to make some savings; for all surveyed and neighboring countries, these figures reach 54% and 44% and 54% and 36% respectively. Among those Ukrainians who make savings, only 12% store it in banks, while others prefer their wallet or cash savings at home. Unfortunately, one in three Ukrainians is characterized by an inability to use money properly to make some profit and continue to invest; one in two is losing money due to a lack of understanding of modern financial services. It is noteworthy that almost half of Ukrainians do not perceive the possibility of tax evasion as unacceptable, at the same time they are interested in what the taxes they pay are spent.

Financial illiteracy is confirmed by the fact that over the past year, more than half of Ukrainians (58%) have experienced insufficient income to offset their own expenses; for comparison, for Poland this figure is 18%. 50% of respondents report late payment of their bills in due time, first of all, it concerns payment of rent, gas and electricity. A third of the respondents borrowed the necessary funds to cover the costs (30%), in Poland the share of such population is 12%.

More than a third of the Ukrainian population is unrelated to the banking sector, which is primarily explained by the level of trust in the banking system, which is insufficient due to a number of financial crises that have led to the loss of all savings in vulnerable groups of the population. In addition, the Deposit Guarantee Fund is not fully able to perform its functions, resulting in a delay of at least six months access to money, conversion at an inconvenient exchange rate of national currency, which leads to great losses. Despite the fact that depositors received from banks UAH 89402 million (information on May 1, 2019), which was transferred to the Deposit Guarantee Fund, it is obvious that the amount of compensation in UAH 200 thousand is insufficient.

According to some experts, for example, representatives of the Savings Bank, a condition of significant development of financial literacy and financial inclusion can be a legally confirmed obligation of every resident of Ukraine, from the age of 16, to have a bank account. Representatives from other entities have considered this position unacceptable, arguing that financial inclusion is an opportunity rather than a liability, and opening a bank account does not guarantee that the user will be able to make full use of it.

The fact that the material well-being of many Ukrainian families does not create the conditions for using bank accounts cannot be ignored. According to the survey, the material well-being of their families was estimated by 6.2% of respondents as very low, 18.2% as low, 30.2% as below average, 40.2% as average, 0.3% as high, 0 , 1% - very high, 0.6% - did not answer. Therefore, the family financial status of the majority of the population (54.6%) is not even considered average.

Financial illiteracy can be overcome only if a reliable system of consumer protection is formed. First of all, it is the state's task to create acceptable conditions for inclusion in the financial system, to provide an effective mechanism for control of the non-banking financial market in order to prevent fraudulent schemes. Taking advantage of the financial illiteracy of the Ukrainians, fraudulent schemes in the form of various kinds of financial pyramids dealing with the theft of public funds are constantly emerging on the market. Unlike the banking system that has undergone a clean up, many financial and insurance companies are not transparent. The inability of consumers to use insurance products leads to the possibility of insurance companies to use this ignorance for selfish purposes, receiving funds and not compensating for losses when insured events occurred.

There is a lack of public awareness of existing financial instruments and it is not enough to organize separate information companies; there is a need to educate consumers to use specific financial instruments in practice. In this sense, the agreement signed by PrivatBank with the Dnieper City Council on cooperation within the Third Age University, which started training pensioners to achieve financial comfort, is indicative. The Third Age University program provides computer and smart literacy training, banking skills, e-banking and mobile banking, retirement and bank card billing, savings and income from banking applications.

The National Bank of Ukraine presents a financial literacy strategy that covers the interests of a wide range of financial relations entities and is focused on coordinating and pooling the efforts of government, business entities, and civil society representatives to increase the level of financial literacy. The strategy has five basic priority decisions: 1) changing the financial culture, including all its components - tax, credit, pension, etc .; 2) formation of a Ukrainian citizen, as a representative of the European community, with high level of financial literacy; 3) focusing on young people aged 10-24 who are able to disseminate financial knowledge among their family members, their relatives and friends; 4) creation of a single communication platform for the purpose of providing synergistic effect in the sphere of trust relations; 5) creation of the NBU educational and information center, which will be represented by the center of education of young people, the center of competence of teachers, the center for visitors, the museum of money.

It is obvious that financial literacy can not be reduced to the ability to use modern financial instruments, but must include knowledge of planning and budgeting of all types of human life. How to make up your own budget properly, plan your expenses based on your existing or future income - these things need to be learned from school age; the decision to include the subject of Financial Literacy in the school curriculum is therefore appropriate.

The problem of professional development of participants in the domestic financial industry requires the solution, as well as ensuring the level of ethics of their thinking and behavior. To improve financial literacy of consumers and the professionalism of financial and investment sector employees it is promised to the CFA Society of Ukraine Investment Professionals to receive a grant from the USAID Association of Transformation of the Financial Sector Project. As stated by the representatives of the Association, the received funds will be used for the following purposes: carrying out a number of measures that will help to improve the professional awareness of financial sector professionals, their meeting of ethical standards; development of a training online video course for consumers of investment services. Particular attention should be paid to increasing the level of financial literacy of domestic entrepreneurs, taking into account that in some countries this trend is beginning to develop intensively. First and foremost, this applies to micro, small and medium-sized businesses, which are particularly in need of financial knowledge, identifying sources of funding and rational use of financial resources.

By definition of the Organization for Economic Cooperation and Development, financial literacy for the specified type of business structures implies the ability to: distinguish their own finances from the finances of the enterprise; understand the peculiarities of different components of the financial environment; to classify and evaluate the financial capabilities of the enterprise and distinguish between different types and consequences of financial risks; develop realistic business plans and make sound financial decisions; to effectively manage financial resources in the short and long term; identify ways to increase the enterprise potential for sustainable competitive advantage.

Conclusions

Financial inclusion creates conditions for involvement of the population and business structures in a wide range of financial services that meet their needs and, at the expense of the development of the financial system, contributes to the development of the economy, foreign investment, improving the quality of life of all citizens. The level of activity of financial services usage by the population is directly related to its material well-being. It is confirmed by the Scandinavian countries, which constantly occupy the highest places in the ratings of the richest and happiest countries in Europe and the level of financial inclusion in which is 100%.

In order to increase the level of financial inclusion in Ukraine, it is necessary to create a favorable regulatory environment for all entities of the financial ecosystem, which would ensure efficient and safe consumption of financial products within the banking and non-banking segments of the financial market. It is advisable to use the experience of modern world practices to create a financially inclusive society on the basis of state-business partnerships. Considering the high level of openness of Ukrainians to innovation, it is important to encourage the use of innovative technological solutions as a factor in the development of the cashless economy by introducing new financial services and improving access to existing ones; create conditions for restoring confidence in professional financial market participants, first of all, banking structures and financial instruments.

Financial literacy is an important precondition for financial inclusion. The application of a comprehensive system of long-term financial literacy should be the priority. It will provide citizens with the specific skills and abilities to use financial services successfully and, on the basis of a qualitative change, to gain knowledge of rational financial behavior and financially stable life.

References

1. National Bank of Ukraine (2020). Strategy of development of financial sector of Ukraine till 2025. Retrieved from: <https://bank.gov.ua/about/refactoring/develop-strategy>. [in Ukrainian].
2. Yakymchuk I. (2020). The National Bank presented a new vision for Ukraine's financial sector till 2025. Retrieved from: <https://vezha.net.ua> [in Ukrainian].
3. Draft Law of Ukraine "On Amendments to Certain Laws of Ukraine on Involving Postal Operators in the Provision of Financial Services from 05.02.2020 № 2788-1 (2020). Retrieved from: http://search.ligazakon.ua/l_doc2.nsf/link1 [in Ukrainian].
4. The Law of Ukraine "On Amendments to Certain Legislative Acts on Improving Functions in State Regulation of Financial Services Markets" from 12.09.2019 No. 79-IX (2019). Retrieved from: <https://zakon.rada.gov.ua/laws/show/79-20>. [in Ukrainian].
5. USAID Financial Sector Transformation Project (2019). Financial literacy, financial inclusion and financial well-being in Ukraine. Retrieved from: <http://www.fst-ua.info>.
6. National Bank of Ukraine (2020). Activity in Ukraine of funds transfer systems. Retrieved from: <https://bank.gov.ua>
7. National Bank of Ukraine (2020). Operations performed using payment cards, 2019. Retrieved from: <https://bank.gov.ua>
8. National Bank of Ukraine (2020). Distribution of non-cash transactions using payment cards, 2019. Retrieved from: <https://bank.gov.ua>
9. National Bank of Ukraine (2020). Payment cards in Ukraine. Retrieved from: <https://bank.gov.ua/>
10. National Bank of Ukraine (2020). Payment infrastructure in 2019. Retrieved from: <https://bank.gov.ua/news/all/platy-infrastructure-2019-rik>. [in Ukrainian].
11. Kudriavtseva Y. (2020). Mastercard vs Visa - Which company is better to invest in. Retrieved from: <https://fomag.ru/news/mastercard-vs-visa-v-kakuyu-kompaniyu-luchshe-investirovat/>. [in Russian].
12. VISA or MasterCard: choose payment system (2019). Retrieved from: <https://bilderlings.com/blog/visa-or-mastercard/>. [in Russian].
13. Overview of popular electronic payment systems in 2020 (2020). Retrieved from: <https://cryptonisation.ru/>. [in Russian].

Larysa Gorodnycha

*Candidate of Pedagogical Sciences, Associate Professor,
T.H. Shevchenko National University «Chernihiv Colehium»
Chernihiv, Ukraine
orcid.org/0000-0002-6795-5958*

Maryna Olkhovyk

*Candidate of Philosophical Sciences, Associate Professor,
T.H. Shevchenko National University «Chernihiv Colehium»
Chernihiv, Ukraine
orcid.org/0000-0003-2789-9194*

Svitlana Gergul

*Candidate of Pedagogical Sciences,
T.H. Shevchenko National University «Chernihiv Colehium»
Chernihiv, Ukraine
orcid.org/0000-0002-6207-7236*

Tetiana Stechenko

*Candidate of Pedagogical Sciences, Associate Professor,
T.H. Shevchenko National University «Chernihiv Colehium»
Chernihiv, Ukraine
orcid.org/0000-0002-5672-3457*

SOCIAL DEMANDS FOR PROFESSIONAL AND PSYCHOLOGICAL PROSPECTIVE EDITORS' TRAINING IN THE CONTEXT OF MODERN JOB MARKET

***Abstract.** One of the important problems of higher education for quite a long time can be considered the situation of graduates' competition at the level of European job market. The proclaimed autonomy of higher education institutions makes it possible to adjust the educational process in accordance with the needs of young people and requirements of the society. The research provides examples of possible interdisciplinary subjects taking into account all social demands. The use of innovative techniques allows students, on the one hand, to use skills and abilities of many disciplines at the same time and on the other hand, immediately attracts future graduates to the problematic working situations, increasing their motivation to study and psychological readiness. The focuses are not on the learning process, but on the results of training within the needs of modern job market and the motivational component will contribute to increasing the graduates' competitiveness while preserving the priority of professional training. Psychological readiness, practical skills, basics of critical thinking, language mobility need to be adequately represented in the learning process. The study shows the integration of various educational and practical components in the process of teaching, which can be realized by the developing of qualitatively new educational programmes, where the formation of the curriculum is subordinated to the competencies and learning outcomes, and most courses are of integrative nature. Therefore, the development and application of advanced training technologies, without which the interdisciplinary approach to the construction of the educational process is impossible, are revealed in the context of the problems raised.*

Introduction.

The new Ukrainian legislative framework in the field of higher education, in particular the implementation of the policy of higher education institutions autonomy, demonstrates the broad perspectives of all specialties educational programs formation, taking into account not only the specifics of the field of study, but also the production necessity, job market demands and students' mobility.

In the context of modern European job market needs and requirements for the country's development strategy, the orientation of modern humanitarian discourse is methodologically demanded not merely on the interdisciplinary approach within the framework of professional training of higher school, but also on the use of the latest techniques simultaneously with the integration of several educational disciplines in order to bring so-called universal professional competence to the fore in the educational process, that is to say such skills and abilities that the student will be able to apply in any socio-cultural coordinates of the world.

Nowadays not only the problems of the higher education development are of great importance, but the outcomes of educational programmes as well, which should take into account the needs of modern job market and focus on a close connection between all components of the educational process, preserving the priority of vocational training. So, some of the most demanded general competencies that today require careful attention and the proper level of establishment are those that are related to practical skills, critical thinking, linguistic mobility and psychological readiness. The analysis of job market of most European countries shows a tendency for promotion of general competences, if not in the first place, then along with the professional ones. A questionnaire for graduates conducted in this study indicates professional mobility and psychological readiness for the specialty as the most expected outcome of educational programmes in order to be competitive not only in Ukrainian but also in European job market. This, in its turn, increases the motivation of students. We believe that only the integration of various educational and practical components of educational process can solve the bulk of professional higher education problems, even the problem of reducing individual specialties academic setting combining learning modules of general courses, such as foreign language and specialized subjects.

The main purpose and tasks of the work were to investigate and outline the ways of prospective philologists' of the specialization "Editor of educational editions" professional and psychological competence development taking into account the motivational component and needs of the modern job market by making the maximum use of the interdisciplinary component. While solving certain problems at different stages empirical and theoretical methods were used, such as observation, description, classification and systematization, as well as a comparable method, elements of component analysis, questionnaires.

Issues of future specialists' professional and psychological training were under analysis of native and foreign scientists (B. Cunningham, L. Gorodnycha, E. Klymova, N. Kuzmina, E. Levanova, M. Markova, S. Nikolaeva, M. Olkhovyk, V. Semychenko, V. Slastonin, Y. Zeer and others). The problem of future specialists' professional and psychological preparation has always been the subject of domestic and foreign scientists' investigations. O. Antonova, S. Honcharenko, O. Dubaseniuk, N. Nychkalo and L. Sirin have elaborated the question of content, forms and methods of pedagogical abilities and skills formation in the professional training context. In particular, prominent Ukrainian methodologist and didact S. Honcharenko attached primary importance to the study of pedagogy by students noting that it is science "about the essence of personality development and formation and as a result on this basis elaboration of the theory and methods of education and training as a specially organized process is done" (Honcharenko, 1997). Continuing his ideas in the monograph "Professional training of future teachers for teaching" the authors (O. Antonova, O. Dubaseniuk, etc.) emphasize that the modern educational process in higher education should not have such negative features as "uniformity, limitations, indifference, slowness, leveling of personality", and focus on "conformist specialists training".

Therefore, the formation of a specialist should take place under the influence of the following disciplines: humanities, psychological, pedagogical and special (Dubaseniuk, 2003).

The content, forms and methods of pedagogical skills formation in the context of professional training were developed by S. Honcharenko, O. Dubaseniuk, N. Nychkalo, L. Sirin. N. Kichuk, Z. Kurliand, N. Nahorna, O. Pekhota, S. Sysoieva devoted their researches to solving problems of preparation for various types of activities.

They believe that the important prerequisite for solving this problem is the usage of a system approach, namely a combination of educational goal, content, organizational forms, methods and techniques. Also, the formation of future specialists' professional orientation as holistic systematic educational and developmental process becomes essential. Its specific components are goals and content of education, processes of studying and upbringing, the activity of subjects of the pedagogical process and organizational forms of educational activity (Kichuk, 2019). Investigating the concept of a person's professional development in the system of continuing education scientist E. Zeer comes to a conclusion that getting an education, mastering a profession, or rather a specialty with a certain level of qualification are crucial in this process. At the same time, the author emphasizes that in modern postindustrial society, which is characterized by dynamic professionalism, socio-economic instability, the introduction of high technologies; general training should provide the graduate with a wide range of professional competencies, including psychological readiness to perform professional activities (Zeer, 2008).

Psychological readiness is studied in accordance with the problems of definition and internal filling of the phenomenon. In general, individual's psychological readiness is defined as intrapersonal education, the structure of which embraces character traits, the development of professionally important cognitive processes (attention, perception, thinking, memory, etc.), psychic state (positive attitude to the profession, motivational mood, etc.), manifestations of temperament and so on.

The state of psychological readiness is considered to be an internal adjustment, adaptation of human capabilities to successful actions at a certain moment. Readiness at the same time is characterized by a state of personality that arises before the performance of any activity and depends on the content and individual's personal qualities. So that, psychological readiness, on the one hand, includes the stock of professional knowledge and skills and, on the other hand, personality's traits that ensure the successful completion of professional pedagogical functions.

1. Professional competence in the system of higher education

First point, professional competence in all educational programmes is put into the first place, and is formed directly by a set of skills of professional training within the defined specialty. In fact, this does not only predict first-class knowledge of the subjects content of vocational and practical training, but also psychological readiness for the chosen profession, the possession of the latest technologies in the specialty, the desire to treat their duties creatively, to acquire knowledge, think, have a good command of languages, at least of Ukrainian and English.

Nowadays, many scientists (Bondarenko, 2007), (Gorodnycha, Olkhovyk, 2018), (Markova, 1996), (Ovcharuk, 2004) define professional competence as a set of professional knowledge, abilities, skills and ways of carrying out professional activity. The main components of professional competence in their opinion are:

– socio-legal competence – knowledge, skills in the field of interaction with public institutions, as well as skills in professional communication and behavior;

- special competence – preparedness for independent performance of specific activities, ability to solve typical professional tasks and evaluate the results of their work, the ability to acquire knowledge and skills in the specialty independently;
- personal (acmeological) competence – the ability to increase professional development of professional skills continuously, as well as to implement yourself in the professional field;
- autocompetence – an adequate idea of the social and professional characteristics possession of technologies to overcome professional destructions.

In addition, an extreme professional competence is distinguished as the ability to act in conditions that have been unexpectedly complicated (Zeer, 2008).

At the same time professional acme, according to A.O. Derkach can be manifested as a man's acquiring of high professional activity levels, professional communication and individual's maturity (Derkach, 2006). Therefore, indicators of maturity of activity, communication and the man of action can be considered as criteria for the presence of types and forms of professional acme. The criterion for the effectiveness of professional activities can be effective and procedural indicators, in particular: efficiency, expediency, conformity of the result to the set goals; the presence of results in the form of a change in the subject of job, the stability of high results; cost effectiveness, minimization of resource costs, participants' time and forces; performance, optimality, achievement of the best result in the given conditions at minimal expenses of time and forces; obtaining results and possessing methods of activity at the level of high samples, standards of the profession (professional skills); setting new tasks, finding non-standard technologies, getting a fundamentally new product, going beyond the existing professional experience (professional creativity); variety of tasks of professional activity; use of socially acceptable and flexible technologies; the formation of a subject of professional activity (the ability of a person to set goals, to realize, to regulate activities); absence of deformations in professional activity; reliance on the past experience gained in the profession and personally; possession of specific types of activities (specialization); possession of several related activities (universalization); possession of knowledge, skills in the profession at the level of requirements to the levels of qualification.

Thus, professional competence is revealed due to the whole complex of personal qualities, on which modern higher education should be focused:

- cognitive – the ability to feel the world around, to ask questions, to find out the causes of phenomena, reveal your understanding or misunderstanding of the issue, etc.;
- creative – inspiration, fantasy, flexibility of mind, sensitivity to contradictions, freedom of thought, feelings, movements; predictability; criticality; the presence of your own opinion, etc.;
- methodological – the ability to understand the purpose of the activity and the ability to explain it, the ability to set goals and organize their achievements; the ability to rule-making, reflexive thinking, self-examination and self-esteem, etc.;
- communicative – caused by the need to interact with other people, with objects of the world around and its information flows, ability to find, transform and transfer information, to use modern telecommunication technologies, etc.;
- worldviews – determine personality's emotional and value settings, their ability to self-knowledge and self-movement, the ability to determine their place and role in the surrounding world, national and universal human orientation, patriotic and tolerant personal qualities, etc. (Khutorskoi, 2007).

At the same time, Ukrainian higher education is still focused on mastering the professional component of a particular specialty, and, namely, the problem already begins at the level of curriculum formation, when there is no interdisciplinarity as one of the main prerequisites for the qualitative results of the educational programme. Psychological readiness of future graduates of higher education institutions, professional skills, and the growing demand for the practical component of the specialty and the lack of technological support in educational institutions are hardly taken into account. The process of the prospective editors' professional training has certain stages and involves general, special and professional, personal preparation of the student for working within specialty, as well as the formation of psychological readiness for professional activity.

The general competences of the editors of educational editions are formed by knowledge on humanitarian and socioeconomic subjects, in particular, ESP (English for specific purposes), the basis of scientific writing, interpretation and its methodology, topical issues of culture and media, computer literacy and technology. Professional training includes the study of linguistics, literary, editorial courses. In this case the educational programme should take into account future specialist's self-education, self-upbringing and self-development (a dynamic and continuous process of a person's self-reflection characterized by growth, formation, integration and implementation of professionally significant personality's traits and abilities, active qualitative transformation by person of his inner world), which is possible only when there is a high motivation to the educational process. Psychological readiness for a specialty is formed only on the basis of a specific vector of special professional training, their personal and motivational assertion, desire to succeed and become competitive in the job market, realizing this to be a continuous lifelong process.

Therefore, three components that are important for the structure of prospective editors' pedagogical and psychological readiness should be personal, individual and professional. It is necessary to pay attention to the motivational component, when a positive attitude is formed for a certain type of activity, desire to be engaged in it; cognitive and gnostic, providing an appropriate level of mastering the means and methods to put various aspects of professional activity into practice; emotional-volitional and evaluation components that indicate the index of self-control and emotional sustainability and self-esteem.

2. Future editors' psychological readiness in the context of job market social demands

The specialty "editor of educational publications" is being studied because of certain versatility, which is expected by the outcomes of their studying. The professional capabilities of the editor are quite extensive and are related to the following spheres: publishing, editing, literary work, editorial manager, writer, journalist, etc. (Tymoshyk, 2006). Correspondingly it requires a future specialist to obtain a range of professional qualities, skills, abilities necessary for a successful career. The professional requirements of the prospective editor are, first of all, extended humanitarian education and, if necessary, the second, special (economic, legal, natural) with possession of one or two foreign languages. The high level of computer literacy and knowledge of such subjects as layout, design, publishing standards are equally important. It should be noted that knowledge of a foreign language should be purely practical, that is, the requirements of the job market predetermine the need to possess their professional knowledge in a foreign language.

The psychological training of a highly skilled worker remains out of the attention of most educational programmes.

Understanding psychological training as a formed system of abilities, professional type of thinking, work ability, orientation of thought, emotional and moral potential, the ability to evaluate critically professional space and their own activities, one should emphasize the importance of its role in the formation of personality settings, not just awareness of the implementation of professional functions, the search for optimal ways of activity, the ratio of their abilities and capabilities, but also the ability to understand and assess the demands of job market and to be constantly competitive.

Mental state is defined as an integral characteristic of mental activity for a certain period of time, which determines the peculiarity of the course of mental processes, depending on the reflected objects and phenomena of reality, the previous state and mental properties of the individual. The main determinants of the status are: a) the needs, desires and aspirations of man (or, more precisely, conscious and unconscious needs, aspirations and desires); b) his capabilities (hidden potentials and abilities that manifested themselves); c) environmental conditions (objective influence, subjective perception and understanding of the current situation) (Grechko, 2010).

Five factors in the mental states, such as: mood, assessment of the probability of success, motivation (its level), level of vigilance (the tonic component) and attitude to work (activity) have been distinguished and combined into three groups: motivational-inductive (mood and motivation), emotionally-estimated (estimation of success probability and attitude to work) and activation-energy (level of vigilance) (Grechko, 2010).

Mental states are distinguished by evolutionary, functional and structural features. According to the evolutionary feature, three levels of emotional manifestation are at the forefront. The first characterizes the emotional (sensory) tone of sensations (feeling of pleasure or dissatisfaction, pleasant or unpleasant), which emotionally paints sensory images and feelings of a person. The second level is emotions that have a clear, objective character. This is a wide range of positive or negative emotions that reflect the situational attitude of a person to an event.

We are discussing one of the global problems in the system of modern higher education, namely, the lack of psychological readiness for both the chosen specialty and the challenges of the job market. In the course of the study, a questionnaire survey of prospective philologists from five regional universities was developed and conducted, within which additional analysis of student employment results was conducted. During questioning we found out that 85% of graduates received profession of the philologist without identifying themselves with this specialty in future. Among the main motives to training were the following: receiving higher humanitarian education, choice of parents, opportunity to get any higher education. Other 15% while obtaining Master's degree had been already working or tried working in philological or editorial field. At the same time only 7% answered with assurance what exactly they expect from the educational programme for their own competitiveness in future. The majority would like or plan to work abroad or for foreign companies. In five years 12% of graduates began to work in their specialty directly, and another 7% indirectly (for instance, advertising agencies, PR managers). These results testify the low level of professional and psychological preparation in the sphere of the higher education, that automatically makes future graduates not competitive in the job market.

After all, psychological readiness includes, first of all, selective focus on professional activity, and only when there is a positive attitude to the specialty and there are motivated needs for this activity.

The aforementioned motivations to study in no way contribute to this. So there are two problems at the same time: how to form psychological readiness for a specialty in the first category (85% of students), and how to develop and support readiness for the specialty in the rest (15%). We can speak about the formed psychological readiness only under conditions of emotional attitude development, the ability to adapt their behavior in accordance with the emerging situations, the ability to build a process of communication and the availability of such psychological abilities as thinking, visualization, observation, communicative skills and complex professionally significant properties (emotional stability, self-control, sincerity, kindness, perseverance, etc.) The source of motives is traditionally considered to be the influence of the environment on person's inner world, determined by internal conditions (personality, psychological states, consciousness, experience), which encourage some activities, including activities in stressful situations.

If we do not oppose these two groups, then we suggest the cardinal review of educational programmes based on interdisciplinary approach and focused on the programme outcomes (especially competitiveness in European job market) expected by students as one of the productive solutions of the discussed problem.

3. The ways of social demands for future editors' professional and psychological training implementation while studying

Having analyzed the theory of readiness (Conley, 2007) we can point out that the readiness of students is determined by the skills and ability to carry out the tasks in the process of activity, particularly in education. It is regulated by the following characteristics: intellectual openness, curiosity, the ability of texts and data interpretation, accuracy of thinking, relevant skills (Conley, 2007). It requires three main elements: basic academic knowledge and skills, the ability to apply these skills in specific situations for functioning at the workplace and in everyday life, the application of special skills necessary in any field. That is why let us interpret the educational programme of the specialization "Editor of educational editions".

The educational programme of the prospective philologists is based on the integral competence, which provides: the ability to solve complex specialized tasks and practical problems in the field of Ukrainian philology; editing; the ability to carry out a reasoned critical review of audiovisual and printed information, which implies the application of certain theories and methods of linguistic, literary, journalistic, publishing, and pedagogical sciences and is characterized by complexity and systemic conditions.

The specialty of editor of the educational publications also requires of the future graduate to form a general control competence, in particular, the flexibility of thinking – willingness to use language and literary knowledge and competences; interpersonal communication skills; the ability to self-examination, self-criticism, self-control; scheduling and time management skills; the ability and readiness to make decisions; the ability to present complex information in a concise form orally and in writing.

The educational programme of this specialty provides the following outcomes: the ability to use knowledge of basic concepts and conceptions of modern linguistic and literary science, to operate freely with linguistic and literary material; the ability to use knowledge in the field of linguistics, literature, to carry out research work; the ability to conduct a dialogue as a way of dealing with culture and society, to be able to express and justify the position; the ability to interpret the information in oral form, translate it and summarize it in writing; the ability to create media texts and media reports and analyze them according to semantic and structural criteria; the ability to

apply rational methods for the search, selection, systematization and use of audiovisual and printed information; the ability to apply knowledge and skills in computer science, to use technical means of translation and teaching, methods and techniques of teaching language and literature; the ability to build information communication in a professional and non-professional circle taking into consideration the existing socio-cultural context.

The programme outcomes show clearly the necessity of new approaches to the formation of a specialty syllabus. In our opinion, the basic one can be the integrated use of teaching methods of general-purpose disciplines with the methods of teaching professionally oriented courses. Such an approach was proposed by M. Brunton (Brunton, 2009), M. Schleppegrell, M. Snow, F. Stoller, about the peculiarities of ESP teachers' professional activities (Kokor, 2015). It can be implemented not only within the framework of foreign language, but also at all courses that form general competences. It will also be expedient to use the mobile forms of organization of the learning process, when the emphasis is on cooperation with the professors of specialized disciplines and the professional environment, which will be facilitated by group and individual work, and the percentage of traditional forms, such as lectures and seminars, will be reduced to the limit. For example, the course of computer literacy and technology should be integrated directly into the specialized disciplines of the editorial cycle and be taught with the involvement of teachers or professional programmers working in the field of publishing. Thus, the course should be constructed so that only one third of all topics concerns only general competences, and two thirds of them must form skills and abilities of the specialty "editors of educational editions".

As we have already mentioned editor educational programme results relate to the skills and abilities that are directly connected with the work on texts, media texts and informational messages. For this reason teaching of editorial analysis and text correction as a part of future editors' professional readiness training is based on the multi-dimensional awareness of the functioning of the text. It is obvious that a future employer would be interested in candidates' knowledge of the mechanism and general structure of the editorial analysis of the text, whether they will be able to assess the authenticity of the factual material and edit accordingly, find resources to check the available factual material. On that account it is essential while future editors' training to develop their skills of independent search and selection of scientific material and its comprehension, the skills of analyzing the logical foundations of the text and compositional techniques, the ability to use scientific, educational, reference, periodical literature, to comprehend the obtained information in order to master the methods of conducting research work; mastering the skills of developing tools for a particular research, self-editorial analysis; qualified transformation of various types of texts (change of style, genre, purpose of the text, etc.), including the creation of new texts on the basis of the transformed text, creation, editing and referencing of journalistic texts, analytical reviews and essays; mastering the methods and skills of stylistic editing of the text keeping its individual and authorial peculiarities unchanged.

To accomplish the tasks, we need the latest teaching technologies that would allow us to apply a multidisciplinary approach on an ongoing basis. Problematic, project, information and communication technologies, case methods (highly structured, short vignettes, long unstructured cases, executive cases, thematic cases, and Harvard cases) allow teachers of different disciplines to integrate the modules of their own disciplines in order to show the results of integration competences formation.

So, within one integrated course, we can teach ESP editorial analysis and editing, publishing standards and topical issues of culture and media at the same time. Case study solving method at the beginning of such a course (for example, the creation of a periodical publication of the European level, the development of an anti-crisis package for the salvation of non-profit media resources, the making of a creative product and an advertising campaign for its sale on the European market, etc.) could be one of the effective approaches. Then, the whole process of the learning is centered on this project task.

One of the most optimal ways to implement such an approach can be wide use in the native higher school case-method varieties, which involves creating or writing a specific situation in a particular professional area, where future graduates can be involved directly or indirectly. This technique is interesting in that it suggests a real problem or contradiction in a particular area; material is often taken from real life, for example, in our case, this is the problem situations of a particular publishing house, printing house or PR agency. The objective of the project is to analyze the given problem and to find the best solutions, in particular, to offer their own project of a competitive publishing house with an economic or socio-cultural orientation, to bring the domestic bookstore to a new economic level, to find new markets for the book products of a particular direction, to introduce new ways of searching and creating qualitative educational products, etc. This suggested way will help to satisfy basic programme learning results of future editors which include the ability to create media text and media reports and analyze them accordingly to semantic and structural criteria; the ability to build informational communication in a professional and non-professional circle, taking into account the social and cultural context.

Among the important features of a case-method for higher education, we can name a purely practical orientation when both teachers direct theoretical training to the implementation of the final project design, and students immediately learn to apply theory and practice skills, which allows prospective editors to detail the specifics of their specialty. The interactive format is equally important, which prompts more effective mastering of the material, because the combination of academic learning with practice already at the initial stage of learning, emotionally attracts students to active and motivated learning. At the same time, the main emphasis is not on mastering the theoretical knowledge, but on the formation of this knowledge in the process. So with the help of new techniques it is possible to improve the so-called "Soft skills" associated with critical thinking, communication, teamwork, leadership skills, etc.

Conclusions.

The problem of professional and psychological training of graduates of higher education remains extremely important in modern job market. Social expectations are much higher, especially in the global market and the ability of domestic students to be competitive requires flexibility in the educational process and high motivation from the students themselves. The latter directly depends on the psychological readiness of future graduates for the chosen profession, their desire to master the latest technologies, constantly improve, and actually see themselves in the profession. All this is possible only if the approaches in the higher education system are updated. Therefore the development of such competences, which are connected with practical skills, critical thinking, linguistic mobility, and psychological readiness, requires special attention. Also, it is necessary to consider the motivational component, the needs of the modern job market, to focus on the interdisciplinarity of the educational process.

The appropriate combination and integration of general-purpose disciplines methods teaching with methods of professionally oriented courses teaching, as well as the usage of mobile forms of organization of the educational process will be a qualitative solution to the raised problems. We must agree on the impossibility of expecting a large number of psychologically prepared students, even with a master's degree, and the educational programme should include criteria for forming both professional and psychological readiness of future graduates for the chosen profession. A prerequisite is the mandatory survey of first-year students, the results of which will show the level of psychological readiness, expectations from training and future profession, will allow to adjust the selective components of the educational programme and focus on the necessary teaching methods.

In our opinion, the questions of non-traditional teaching forms use (trainings, role and imitation games, group work, etc.), organization and conducting of practice, self-study work, and individual creative projects of informal and dual education remain extremely important. The investigation shows the need for differentiated approach concluding the curricula in view of the specialty and, accordingly, the social expectations of professionals in the chosen profession. The analysis of the specifics of future editors' training shows that psychological readiness, along with professional, can become an important criterion for the competitiveness of domestic philologists in the labor market. The future editors' training in higher education requires special attention to the formation of general competencies, such as critical thinking, a high level of communication, teamwork, flexibility in decision-making, and so on. It is important to organize editorial practice, independent work taking into account the needs of the labor market, development of case methods with the involvement of competent representatives of the professional market. It is the study and development of new techniques, the integrated use of teaching methods of general cycle disciplines with methods of teaching professionally oriented courses that we consider promising for further research.

References

- Bondarenko, O.M. (2007). Psychological and pedagogical approaches to the definition of "competence". *Pedagogical process*, 3, 31–41 [in Ukrainian].
- Brunton, M. (2009). An account of ESP – with possible future directions. *English for specific purposes*, 3(24), volume 8, 1–15.
- Conley, D. (2007). Towards a more comprehensive conception of College Readiness. A report prepared for the Bill and Melinda Gates Foundation. Eugene, OR: Educational Policy Improvement Center, Retrieved from <https://docs.gatesfoundation.org/documents/collegereadinesspaper.pdf>
- Cunningham, B. (2018). Pensive professionalism: The role of 'required reflection' on a professional doctorate. *London Review of Education*, 1, Volume 16, 63–74. Retrieved from: https://discovery.ucl.ac.uk/id/eprint/10043542/1/LRE%2016-1_paper%207.pdf.
- Derkach, A.A. (2006). *Akmeology* Moscow: RAGS [in Russian].
- Dubaseniuk, O.A., Semeniuk, T.V., Antonova, O.E. (2003). *Professional preparation of the future teacher for pedagogical activity*: Monograph. Zhytomyr [in Ukrainian].
- Career Readiness Curriculum Guide. Retrieved May 18, 2020, from http://commcorp.org/wp-content/uploads/2016/07/resources_eyf-career-readiness-curriculum-guide.pdf

Gorodnycha, L.V., & Olkhovyk, M.V. (2018). Articles editing as means of developing professional competence while teaching English for academic writing. *Visnyk of Kyiv National Linguistic University, Series "Pedagogy and Psychology"*, 28, 61–69.

Grechko, T.P. (2010). General characteristics of the basic mental states of the individual. *Bulletin of the National Academy of the State Border Guard Service of Ukraine. Psychological sciences*, 4, 122–127 [in Ukrainian].

Honcharenko, S.U. (1997). *Ukrainian pedagogical dictionary*. Kyiv: Lybid.

Khutorskoi, A. (2007). *Modern didactics*. Moscow: Higher school [in Russian].

Kichuk, N.V. (2019). Preparedness of a Specialist for professional reflection in activity as a parameter of his / her competitiveness. *Scientific bulletin of South Ukrainian National Pedagogical University named after K. D. Ushynsky*, 3, 15–19 [in Ukrainian].

Kokor, M.M. (2015). Challenges for teachers of English for specific purposes in higher education. *Scientific Issues of Ternopil National Volodymyr Hnatiuk Pedagogical University. Series: Pedagogy*, 1, 189–195 [in Ukrainian].

Levanova, E.A., Berezhnaya, I.F., Fedorov, V.A., Tarasuk, N.A., Krivotulova, E.V., & Pankova, T.N. (2019). Individual Learning Path for Future Specialists' Development. *TEM Journal*, 8(4), 1384-1391.

Markova, A.K. (1996). *Psychology of professionalism*. Moscow: International Humanitarian Fund "Knowledge" [in Russian].

Nikolaeva, S. (2015). The Bologna process in Ukraine: the decade anniversary. *General and professional education*, 4, 66–74.

Ovcharuk, O.V. (2004). *Competency Approach in Modern Education: World Experience and Ukrainian Perspectives*. Kyiv: K.I.S [in Ukrainian].

Tymoshyk, M. (2006). *Book for author, editor, publisher: Practical Guide*. Kyiv: Our Culture and Science [in Ukrainian].

Zeer, E.F. (2008). *Psychology of professions*. Moscow: Academic project [in Russian].

Olha Kuzmenko

*Ph.D., Associate Professor, Associate Professor at the Department of Physics and Mathematics
Flight Academy of the National Aviation University,
Kropyvnytskyi, Ukraine
orcid. org/0000-0003-4514-3032*

Sofia Dembitska

*Ph.D., Associate Professor, Associate Professor at the Department of Safety and Pedagogics of
Security,
Vinnytsia National Technical University,
Vinnytsia Ukraine
orcid. org/0000-0002-2005-6744*

Serhii Radul

*Ph.D., Associate Professor at the Department of Foreign Languages,
Flight Academy of the National Aviation University,
Kropyvnytskyi, Ukraine
orcid. org/0000-0002-0899-3719*

**IMPLEMENTATION OF STEM-EDUCATION ELEMENTS IN THE PROCESS OF
TEACHING PROFESSIONAL SUBJECTS IN TECHNICAL INSTITUTIONS OF HIGHER
EDUCATION**

Abstract. *The training of competitive technicians stipulates finding ways to build professional competence effectively while studying in institutions of higher education. A perspective way is the introduction of STEM education. The analysis of foreign researchers' scientific achievements revealed that in the process of specialists of technical specialties training the use of STEM technologies enables it to provide intensification of students' educational and cognitive activity and, accordingly, the quality of their professional training. The article proposes innovative 3d design model in the process of training of specialists of technical specialties based on the application of STEM-education means. In the process of experimental research, the analysis of educational results of students of technical specialties of Flight Academy of the National Aviation University and Vinnytsia National Technical University was effectuated. Methodical recommendations were suggested for the use of three-dimensional graphics programs to solve the problems of mathematical modeling of certain real objects. The necessity of using 3D models in the process of professional training is that future industrious persons must understand the features of machines and mechanisms. 3D modeling allows reproducing the process under study as accurately as possible. Surveys and statistical data processing have proven the effectiveness of innovative 3D design technologies in the context of STEM-education. The prospects for further research are considered in content filling of safe cycle's disciplines with methodological materials. It allows ensuring the implementation of the 3D model, taking into account the concept of STEM-education during the whole process of professional training in higher-educational institutions of technical direction.*

Introduction.

The development of innovative STEM-education model is one of the priority areas for educational development in the context of globalization processes. This is due to the fact that the use of STEM-technology allows exciting the curiosity of individuals of study in subjects of the natural-scientific cycle, which creates preconditions for the activation of educational and cognitive activity, encourages them to creative search, development of scientific and research abilities. It also allows forming professional competence on high level.

The complexity and versatility of STEM-education requires the collaboration of specialists in various fields of research. The following means to implement STEM- technologies are used: online course materials; electronic study guide; visualization of mathematical and physical objects under study; research projects that address the challenges of career-oriented direction, 3D modeling, prototyping, digital labs, and more.

The purpose of study is to ensure the quality of educational process by studying natural-scientific and professional subjects in higher-educational institutions of technical direction on the basis of creating innovative 3D design model in the context of STEM-education.

The introduction of innovative 3D design model (according to which the implementation of STEM-education technologies in the process of professional training takes place) will ensure intensification of students' educational and cognitive activity in higher-educational institutions of technical direction and improve the quality of education.

The objectives of study are to develop innovative 3D design model that represents the elements of STEM-education in order to introduce it into the process of specialists training in higher-educational institutions of technical direction; to create computer-based learning environment with original software; to develop cycle of laboratory works of physics with the use of information-communication and digital technologies for improvement of educational process in higher-educational institutions of technical direction; to define interconnection between general and professional subjects in the process of specialists training by means of the use of STEM education technologies and the creation of STEM-center to coordinate research activities of students.

1. Using basic methods to investigate the effectiveness of the introduction of STEM education elements

The study was conducted using the methods of theoretical and empirical research: analysis and synthesis to clarify the main tendencies of the STEM-education model development; conceptual-comparative analysis for confrontation of traditional and STEM-oriented approaches, curricula and programs, psychological-pedagogical and scientific-methodological sources, materials of scientific-practical conferences on the problem of research, innovative pedagogical experience; separation of naturally determined phenomena and formulation of conclusions from the problem under study; structural-systematic analysis and synthesis for constructing theoretical 3D design model in the context of STEM-education, which is introduced in the educational process of technical institutions of higher education, as well as observatory methods (direct, indirect, included observation) for the study of STEM-education centers activities (STEM-centers, STEM-labs, etc.).

Students of technical specialties of Flight Academy of the National Aviation University and Vinnytsia National Technical University participated in the study. The effectiveness of innovative 3D design technologies in the context of STEM-education is displayed in Table 1.

Table 1. Efficiency of application of innovative 3D technologies,%

Methods of teaching (training) material presenting in technical institutions of higher education	Storing information in memory over a certain period of time		
	5 hours	5 days	1 year
Lecture-story	65	11	4
Lecture + innovative ICT	74	27	15
Lecture (distinguishing the components of STEM-education)	83	63	31
Lecture + 3D technologies + STEM-education elements (practical examples)	97	95	74

The creation of 3D model based on STEM-education technologies for its implementation into the process of professional training of future technicians was based on the assumption that they must provide comprehensive solutions to typical tasks they face, taking into account their technical profile and higher education standards. These tasks include: knowledge of terminology in technical and natural sciences, knowledge of programming languages, English, computer technology design, development of computer didactic materials, distance learning computer software, object-oriented computer technology design.

One of the important factors in training specialist of technical profile is his / her ability to work with 3D graphics and create models. Modeling is one of the design phases used in computer graphics. There are mathematical, physical, pedagogical, psychological and other.

Modeling is generally regarded as a process of exploring phenomena, systems, processes by constructing their models [1].

The dictionary of foreign words states that model is imaginary or conditional image (representation, diagram, description) of any object, process, phenomenon used as its representative [2, p. 408]. The process of creating and researching a model is called modeling. D. Hanych and I. Oliynyk take a view of consideration as a method of scientific research which is to build and study a model of the object under study [3].

According to A. Lytvyn [4], the model of training is an abstract reflection of pedagogical naturally determined phenomena by means of their description in the language of logical and mathematical symbolism [4, p. 150. L. Vishnikina [5] indicates that pedagogical modeling is the creation of an artificial sample, which has symbolic (sign) form used to reflect and reproduce into simpler structure of multifactorial phenomenon. The direct study of it gives new knowledge about the object of study [5, p. 81].

According to the Oxford English Dictionary Online [6], the definition of "the model" is not common; it is specified for each sphere. An interesting definition of the model is offered by Merriam-Webster Online Dictionary [7], according to which the model is "system of postulates, data and conclusions presented in the form of mathematical description of an object or the actual state of things".

The modeling process is characterized by complexity and versatility. Scholar V. Bezrukova [8] considers modeling as one of the other phases of design and project activity that reveals the content of STEM-education, specifically: phase I – modeling; phase II – designing; phase III – constructing.

According to M. Koliada [9] we review the definitions of these phases:

1. Pedagogical modeling or model creation – the development of goals for creating pedagogical systems, processes or situations and the main ways to achieve them.

2. Pedagogical designing or project creation – further development of the created model and bringing it to practical use.

3. Pedagogical constructing or construct creation – particularization of the created project that brings it closer to being used in specific circumstances by real participants in educational relations [9, pp. 96-97].

Models are classified:

– Symbolic (sign) models – are represented by a set of characters (e.g. symbols, text fragments, geometric shapes);

– Non-symbolic – abstract models that, before becoming a sign, functionate in the mind of the person at the level of conception, imagination. Models derived from deduction are called mental or non-verbal.

Research on the issue of future specialists' foreign language communication training indicates its importance in the structure of professional competence of specialists in technical specialties. So, in the conceptual model SHEL (Software, Hardware, Environment, Liveware) – «Foreign language» (FL) functionates in several interfaces. In subject-object interface, FL functions in technical support of foreign aircraft, devices (instruments) marking. In subject-procedural interface, FL is reflected in regulations, flight instructions, checklists, standard operating rules, and software. The most important is subject-subject interface, as it realizes communication between the pilot and the air traffic controller, which is obligatory use of FL on international routes.

The mastering of the components of foreign language communicative competence by students of technical specialties occur more effectively in the conditions of intensive speech activity, especially in new professionally-oriented situations for them. In this context, it is an activity approach in foreign language training. It is necessary to stimulate the students' mental and vocal activity, to involve them in direct participation in the speech activity and to maximize their active participation in both independent work and collective forms of educational interaction that characterize STEM-education.

Thus, foreign language competence that is included in the STEM-competence (as a set of competencies) of future specialist in the technical field includes: linguistic competence (knowledge of linguistic means, knowledge of linguistic material, rules for its using); thematic competence (having extra-linguistic information); pragmatic competence (the ability of user to logically associate sentences to produce coherent segments of speech); socio-cultural competence (knowledge of socio-cultural context); compensatory competence (ability to reach mutual understanding); educational competence (ability to use references and vocabulary to ensure adequate language skills for professional communication); communicative competence (the ability to communicate without creating tension with the interlocutor, i.e. the ability to cooperate).

The work of [10] G. Dudich dedicated to finding ways and means of improving the quality of competitive professionals training. Theoretical and practical principles of the educational process organization (methodological approaches, definition of concepts, ways of formation of professionally important qualities in the implementation of STEM-education in the educational process of higher and general educational institutions of Ukraine) are defined in the works of Ukrainian scientists [11; 12].

The national reports, which outlined recommendations for the implementation of STEM-education reform, were published in Australia, England, Scotland [13; 14], the Netherlands, USA [15]. Australia, China, England, Korea, Taiwan, USA are working on the development of the K-12 STEM curriculum, which is designed as set of integrative interdisciplinary approaches in each of the STEM disciplines. Much attention is paid to these curricula so that students are aware of how STEM will affect their future careers [15]. Institutions of general education and extracurricular professional establishments in France, Japan, South Africa are involved in the development of non-registered STEM-education programs (summer camps, extracurricular, competitions, etc.) that draw students' attention to STEM-professions and provide opportunities for study in various fields of STEM-education [16].

Foreign scholars are actively discussing the prospects of using STEM-education in different educational institutions. In particular, J. Wall [17] provided an overview of the use of STEM-technologies during the study of natural and mathematical disciplines; E. Baran, S. Bilici, and Mesutoğlu [18] considered special features of the use of STEM-technologies in extracurricular education; M. Gorlu, R. Capraro and M. Capraro substantiate the need to use STEM-technologies to effectively train professionals in new occupations; J. Coleman [19] considered possible problems in the process of STEM-education implementation; G. Tilus [20] identified the peculiarities of teacher's activities in the process of using STEM technologies; C. Teevasuthonsakul, V. Yuvanatheeme, V. Sriput, and S. Suwandecha [21] have developed practical recommendations for the use of STEM-technologies in the study of physics in secondary education institutions; S. Singer, N. Nielsen and N. Schweingruber, H. A. [22] have developed recommendations for improving the educational process in higher-educational institutions of technical direction.

Of interest are Katherine Scott's study results of [23], which analyzed 10 scientific, technological, engineering and mathematical institutions of higher education in the United States that implement STEM-education.

2. Elements of modeling as a factor of formation of STEM competence in students of technical institutions of higher education

The content of direct computer modeling is – based on mathematical model by using computer a series of experiments are performed and the properties of particular object or process are examined, which is difficult or impossible to study in the real world. The desired parameters and characteristics are calculated. Computer modeling is considered as:

- 1) Creation of model (mathematical, informative and descriptive, visual), similar to the original of the object under study or process model [24];
- 2) Modeling of process or object using program realization by computing system [25];
- 3) Process of transferring essential properties from primary object to another object called computer model [26].

In the scientific sources (on the use of computer graphics systems) different activities using computer means are considered – designing, modeling, constructing, projecting, etc.

The glossary of computer terminology notes that «Project is unique activity that has beginning and end in time, aimed at achieving particular result, creating specific, unique product or service» [24, p. 257]. Thus, computer modeling is one of the stages in more general process – designing. J. Leach [27] refers to the design process of realizing an idea as specific choice or system that requires reiterated improvement of the idea itself. Traditionally, while designing, sketches, drawings, illustrations, two- and three-dimensional models, prototypes are used.

The term «computer modeling» is universal and at the same time multiform. In practice, many related concepts are used: CAD, computer graphics, virtual reality, BIM, PLM and others [28].

In the context of our study, design will mean a set of works that we use to create new object or choice, to calculate its structure (design), to determine the directions of modernization in order to solve educational task. On the basis of the analysis of three-dimensional computer design from the point of view of solving typical tasks of engineer's professional activity, the structural and functional 3D designing model was developed, which includes: the platform of the operating system on which the software package runs; scope of 3D design tool; interface language; availability of educational materials; availability of ready-made object libraries; functionary possibilities for performing all phases of 3D design (Fig. 1).

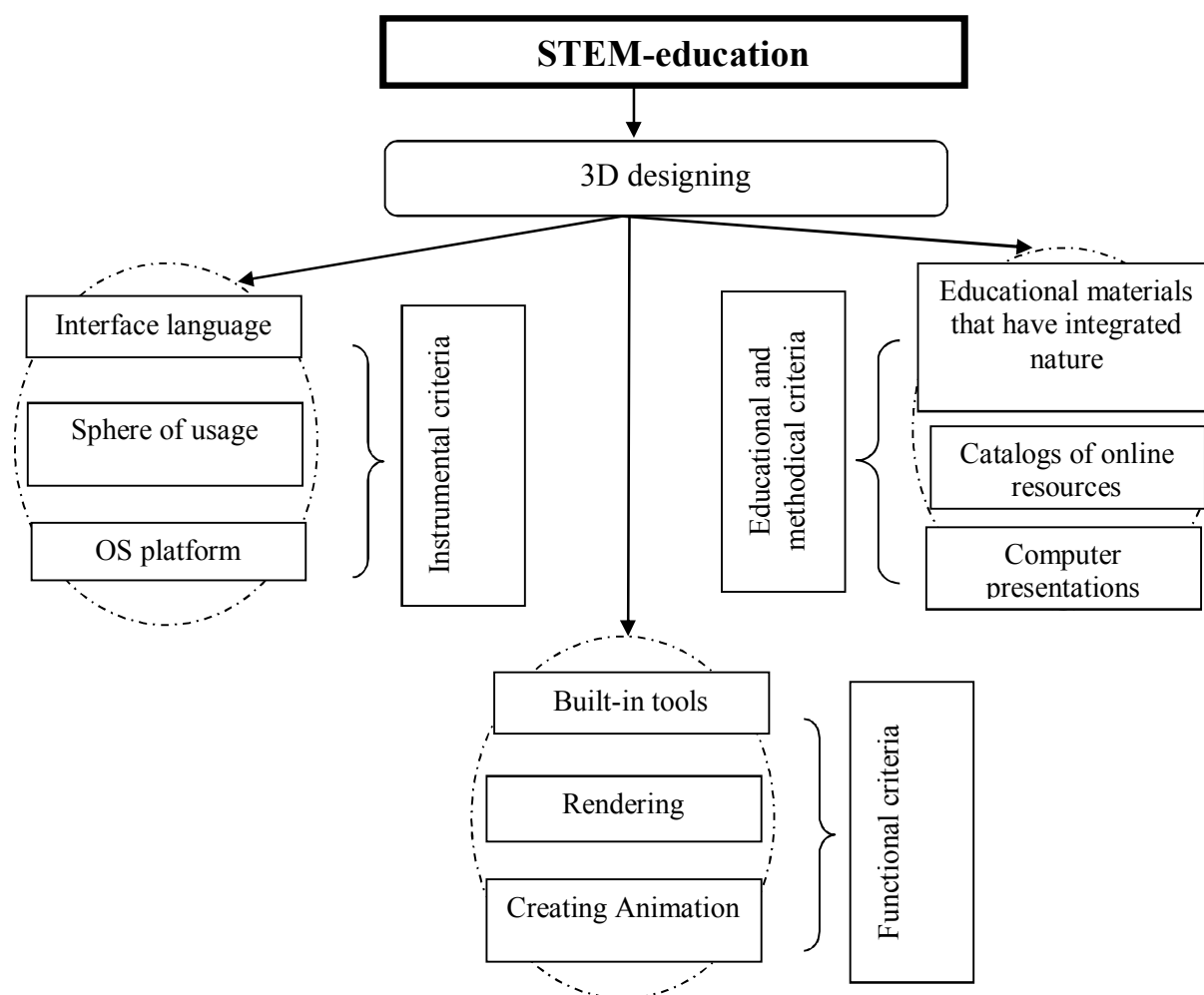

Fig. 1. Structural and functional scheme of 3D in the context of STEM-education

Table 2. Characteristics of innovative 3D design model in the context of STEM-education

Innovative training models	Features of 3D design model implementation	Development of basic characteristics in the traditional model of training
Context training	Integration of different activities (educational, scientific, practical). Creating flexible conditions that are as close to real as possible.	Increase in the part of students' practical work.
Imitation training	Use of simulation and game forms of training.	Increase in the part of active learning methods
Model training	The content and volume of the training material are structured for the purpose of its full learning, which is accompanied by the obligatory blocks of application of different level of tasks' complexity and control for each fragment.	Specific organization of training (study) material – in the most compressed format.
Problematic training	A problematic situation is created, as a result of which the students are initiated to solve problems with the use of innovative technologies (for example, STEM technologies).	Change of character of educational task, educational work (from reproductive to productive, creative).
Full mastering of knowledge	Development of variants of achievement of educational results (on the basis of parameters' change of learning conditions) for beginners with different abilities.	Development of attention and its focus on fixing learning results.
Distance training	Great access to educational resources, a mediated role of the teacher, paying considerable attention to the student's independent and autonomous learning.	Use of the up-to-date information and communication technologies of training.

These components define the criteria for comparing three-dimensional design systems: instrumental (operating system platform, scope, interface language (for example: English); training and methodological (manufacturer support, study materials; functional (built-in tools, object libraries) (Table 2). Let's look at the three-dimensional graphics programs that we use in the training process in educational institutions of technical direction.

3D Stedio Max is professional system for creating 3D graphics and animations. The software is available in two versions: for multimedia needs and for visualization professionals, projectors (planners), architects and designers. With 3D Max, you can create variety of three-dimensional computer models of real, or fictitious, objects of the environment by shape and complexity. The modeling process can be performed using multifarious modeling techniques and mechanisms, including: polygonal modeling; based on heterogeneous rational B-splines (NURBS), Bezier surfaces (Editable patch), using built-in libraries and modifiers. Modeling methods can be combined with each other. There are a number of plugins available for 3D Studio Max that extends its functionality. It has proven itself as multifunctional software product with the ability to be used in various fields of human activity. There is a large number of educational materials, ready-made model libraries, the opportunity to model using different methods, as well as the availability of free license for higher-educational institutions. This system is most suitable for training future engineers of technical specialties.

3. Implementation of innovative STEM kits in the educational process of higher education institutions

Maya is universal system by means of which the creative process of modeling, 3D animation, rendering, motion tracking, creating integral image by combining two or more layers of video film are effectuated. This three-dimensional editor can modulate the physics of solids and soft bodies, motion elements, contains animation elements. *Compass-5* is universal system that includes the drawing-graphic editor COMPAS-GRAPH-5, application development tools, a set of libraries, construction applications for designing parts such as rotation bodies, springs and automatic design of drawings on them, as well as utilities for sharing other CAD / CAM systems via standard DXF and IGES formats [29]. Consider the main components of Compass-5.

1. *Drawing and design editor of Compass-Graph (Fig. 2)* is equipped with many new functions and opportunities. It realizes all types of linear, angular, radial and diametrical dimensions, automatic representation of tolerances, selection of measure of accuracy according to given marginal deviations, possibility of flexible editing of lines, etc. Drawing design objects include all types of rough surfaces, line of footnotes, base and tolerance designations, cut and intersection lines, outlook arrows.

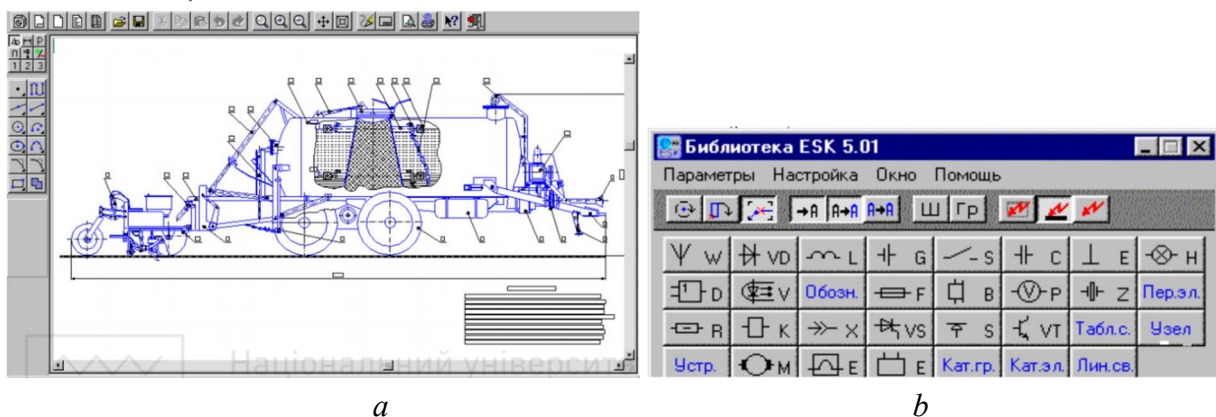

Fig. 2. The window of Compass-Graph-5 design and drawing program: *a* – working window of Compass-Graph program; *b* – working window of the library with electric diagrams.

Compass-Graph-5 provides the student with all the necessary tools for editing the drawing, which is able to quickly and conveniently perform operations of shifting, rotating, scaling, symmetry, copying, deformation, deletion, alignment. The built-in module for calculating mass-inertial characteristics allows you to quickly compute parameters of the designed part or assemblage, as well as facilitates the search for the most optimal variant of the design.

2. *Parametric capabilities of Compass-Graph -5.* It is possible to draw images with synchronous tasks of the law of construction in CAD, which, however, is impossible or very difficult to change in the event of error. Working in parametric mode, it is possible to impose various dimensional (linear, angular, radial and diametric) and geometric (parallel, perpendicular, contact, point-to-curve, point-fixing, etc.) limitation on model objects. These limits can be determined without explicitly performing numeric values. For example, limitations such as circle radius or size can be expressed by algebraic equations and variables, making it easy and quick to establish relationships between parameters. The difference between parametric model and ordinary model is that it provides for relationships between objects. The congruence of points and the position of point on the curve are parameterized by performing of the given affixment point, and the conditions of parallelism, perpendicularity and contact in the corresponding processes of objects input.

Additional interconnections and limitations can be assigned to drawing objects at any time when working on document. Commands for assigning such links and limitations are in separate dashboard. Accordingly, you can at any time remove limitations on one or more selected objects.

3. *Compass-Graph -5 design applications* consist of:

- machine-building library – includes more than 200 parametric images of various typical elements (drawings of profiles, design places, connection elements, etc.);
- libraries of hydraulic and pneumatic diagram circuits – a large number of typical images of blocks, valves, throttles, capacities is given, as well as valves of pressure, measuring instruments, cylinders, etc.;
- libraries of electrical circuit elements (Fig. 2., b) – includes inductive elements, diodes, power sources, commutation devices, capacitors, lamps, microcircuits, optocouplers, acoustic and electrical devices, relays, electric motors, electrometric devices and other elements;
- library of kinematic circuit elements – used in designing drawings of various kinematic circuits. The library contains typical images of kinematic pairs, links, screws, nuts, flywheels, bearings, springs, pushers, pulleys and other elements;
- Compass-Manager – organizes the collaboration of users with electronic documents, saving and protecting them against unauthorized changes. For easy work with the design documentation, modes of displaying selection elements in the form of «tree» of assembly units, hierarchical or linear list, entry list and auxiliary display mode are supported.
- system of projecting specifications – automated generation of text design documents for the collective drawing. The greatest effect is achieved when the standard drawing uses the standard elements of the engineering library;
- COMPASS-MASTER application development means – creation of additional modules. The standard features of the drawing and graphic editor can be supplemented on the basis of those special tasks that have to be solved by the user. Application development means are a collection of libraries that are dynamically connected and used with any standard programming system in C, C ++, PASCAL;
- COMPASS-SHAFT rotating body design library – designed for projecting parts (rotating bodies with synchronous automatic generation of their drawings). This library includes tables of tooth-wheel parameters, portable elements, plan of control, and more.

– COMPASS-SPRING cylindrical helical springs design library – ensures the design and testing calculations of helical spring of distension and compression with the simultaneous formation of the drawing. The calculation is performed with the minimum amount of output data and guarantees the necessary parameters of the spring with its minimum mass. The designer can vary diverse spring parameters during the calculation to obtain the best result. The library allows 15-20 times to increase the speed of designing helical springs and producing documentation on them;

– library of technological equipment elements – used in the design of technological equipment drawings. It contains parametric images of various structural elements;

– DXF and IGES support library. The means of exchange with other CAD packages in the new version has been significantly improved to maximize data compatibility. The COMPASS-5 libraries include the function of importing DXF and IGES file formats as well as exporting COMPASS drawings and fragments to these formats.

Based on the tasks of specialists training in technical institutions of higher education in the context of STEM-education, consideration should be given to the formation of students' STEM competence. Foreign language competence is one of the main components of students' STEM competence. In the field of foreign language education, it is important to consider the formation of foreign language competence, taking into account the specificity of professional interests within the specialty - specialized content (special terminology, typical communication situations and genre specificity of professional language), as these points are important for segregation of main STEM-education elements. Principles of organization of foreign language teaching on the basis of professionally directed STEM-technology contribute not only to fast and effective mastering of language skills and practices, but also characteristic abilities, namely [30]:

- to identify features of form, meaning and use of linguistic units;
- to compare the phenomena of foreign language with their equivalents in their native language;
- to analyze lexical and grammatical phenomena of the language being studied;
- to choose appropriate language means for communication;
- to use practically all modern technical means of training to form foreign language communication skills.

Conclusions.

The results of this accurate study confirmed the benefits of using STEM-technologies in the process of training specialists in technical specialties.

Meanwhile, in order to promote technical training orientation among students in Ukraine, modeled on the Lead the Way [31] project, «STEM: professions of the future» project was launched. The project is being implemented within the framework of the program of European organization CSR Europe (Brussels) – “Deploy Your Talents» [31] – Stepping up the STEM Agenda for Europe.

Features of computer simulation and 3D modeling were considered in the works of such scientists as J. Leach [27], D. Wang, X. Zhang, [32], I. Slipuhina, T. Gedenah, V. Olhovyk [33], M. Eliseev, T. Tomchinskaya, A. Lipenkov, and A. Blinov [34].

The analysis of abovementioned scientific researches displays that the current state of STEM-education implementation in Ukraine is at the stage of familiarization with the leading ideas of international higher-educational institutions in the field of STEM-education technologies and models, processing and development of various curricula that differ in content, direction, complexity level of natural-scientific and technical disciplines, which are necessary for training of highly skilled specialist in technical direction.

Therefore, the specificity of 3D design in the context of STEM-education is, on the one hand, in the design activities, on the other – in pedagogical design, and on the third - are features of computer design. Considering the multidimensionality of 3D computer-aided design, 3D designing professional model, that displays algorithm for constructing 3D image, displays elements of STEM-education and STEM-competence. The integration of the proposed model makes it possible to substantiate meaningful content of all components of training and therefore creates the basis for the development of systems training methodology of three-dimensional computer-aided design for engineers of technical specialties.

The implementation of 3D model, taking into account the concept of STEM-education and the development of teaching methods of natural-scientific subjects, consists in content-filled specific components of training models.

Prospects for further research are to determine succeeding theoretical and methodological foundations and to develop training methods for three-dimensional computer simulation in the context of STEM-education in the process of studying professionally-oriented subjects by individuals in technical institutions of higher education.

References:

1. Stakun, G. A. (2010). *The place and role of modeling in the system of scientific and artistic knowledge*. Extended abstract of candidate's thesis. Cheboksary: ONTU [in Russian].
2. Bibik, S. P. & Sutta, G. M. (2006). *Dictionary of Foreign Languages: Interpretation, Dictionary and Word*. Kharkiv: Folio [in Ukrainian].
3. Hanych, D. I. & Oliynyk, I. S. (1985). *Dictionary of linguistic terms*. Kiev: High School.
4. Litvin, A. W. (2011). *Informatization of vocational schools of construction profile: monograph*. Lviv: Manuscript Company [in Ukrainian].
5. Vishnikina, L. P. (2008). Pedagogical modeling as a basis for designing educational processes. *The image of the modern teacher. Scientific-practical educational-popular magazine*. Poltava, No. 7-8 (86-87), 80-84 [in Ukrainian].
6. Oxford English Dictionary Online. Oxford University Press (2015). <http://www.oed.com/>
7. Merriam-Webster Online Dictionary. Merriam-Webster (2015). <http://www.merriam-webster.com>
8. Bezrukova, V. S. (1996). *Pedagogy. Projective pedagogy*. Ekaterinburg: Business book.
9. Kolyada, M. G. (2006). General principles of pedagogical design and activity approach to its implementation. *Problems of modern pedagogical education: pedagogy and psychology: Coll. of sciences. works*, V. 12, P. 1, 95-101 [in Ukrainian].
10. Dudich, G. (2017). STEM: Orbiting Opportunities. *Education of Ukraine*. №31. 12–13.
11. Patrikeyeva, O. & Chernomorets, V. (2017). Modern STEM literacy tools. *Scientific notes of the Small Academy of Sciences of Ukraine. Series: Pedagogical Sciences*, Vol. 10, 8–17.
12. Strizhak, O. E., Slipukhina, I. A., Polihun, N. I. & Chernetsky, I. S. (2017). STEM education: basic definitions. *Information technology and training tools*. Kiev: IIITS of the National Academy of Pedagogical Sciences of Ukraine, T. 62, № 6, 16–33 [in Ukrainian].
13. Barcelona, K. (2016). 21 st Century Curriculum Change Initiative: A Focus on STEM Education as an Integrated Approach to Teaching and Learning. *American Journal of Educational Research*, 2(10), 862-875. <https://doi.org/10.12691/education-2-10-4>.
14. STEM education and Training Strategy for Scotland. (2017). The Scottish Government, Edinburgh.

15. Fan, S. C. C. & Ritz, J. (2014). International views of STEM education. *Proceedings of the pupils attitude toward technology conference*, Orlando, USA.
16. Siekmann, G. & Korbel, P. (2016). Defining ‘STEM’ skills: Review and synthesis of the literature. National Centre for Vocational Education Research (NCVER), Retrieved from <https://www.ncver.edu.au>.
17. Wall, J. (2016). A science, technology, engineering and mathematics (STEM) review of the research. *Scan*, 35(2), 27–41.
18. Baran, E., Bilici, S. C., & Mesutoğlu, C. (2016). Moving STEM beyond schools: Students’ perceptions about an out-of-school STEM education program. *International Journal of Education in Mathematics, Science and Technology*, 4(1), 9-19 Barcelona, K. (2014).
19. Coleman, J. (2018). Focusing on the Problem in STEM Education. Retrieved from website: <https://www.scientia.global/dr-john-coleman-focusing-on-the-problem-in-stem-education/>.
20. Tilus, G. (2015). The Promotion of Teaching Science and Technology (IPST). STEM education: Preparing a workforce for the future. Retrieved from <http://eng.ipst.ac.th/>.
21. Teevasuthonsakul, C., Yuwanatheeme, V., Sriput, V. & Suwandecha, S. (2017). Design Steps for Physic STEM Education Learning in Secondary School. *Journal of Physics*. 901.
22. Singer, S.R., Nielsen, N.R. & Schweingruber, H.A. (2012). *Discipline-based Education Research: Understanding and Improving Learning in Undergraduate Science and Engineering* Committee on the Status, Contributions, and Future Directions of Discipline-Based Education. Research Board on Science Education Division of Behavioral and Social Sciences and Education. National Research Council of the National Academies.
23. Scott, C. (2012). “An Investigation of Science, Technology, Engineering and Mathematics (STEM) Focused High School in the U.S.” *Journal of STEM Education*. Volume 13.
24. Dodonov, A. G., Lundy, D. V. & Putyatin, V. G. (2011). *Computer information-analytical systems. Explanatory Dictionary*. Kiev: Scientific Opinion [in Ukrainian].
25. Gondol, VP, Derev'yanko, AG, Matveev, VV & Prokhur, Yu. Z. (2000). *Informatics and computing: a short explanatory dictionary*. Kiev: Libid [in Ukrainian].
26. Kozak, I., Menshutkin, V. & Llekowski, R. (2003). *Modelowanie elementow krajobrazu*. Towarzystwo Naukowe KUL.
27. Leach, J. (2002). AutoCAD 2002. Encyclopedia. St. Petersburg: Peter [in Russian].
28. EDS Unigraphics: Computer Aided Design, Engineering Calculations, Production Preparation, Project Management (1996). *Publication of the International Center for Information Technology INT*. Kiev [in Ukrainian].
29. CAD / CAM / CAE COMPASS-SCHEDULE 5 (1999). *Publication of the International Center for Information Technology INT*. Kiev [in Ukrainian].
30. Tadeeva, M (2009). Forming the pedagogical competence of a future foreign language teacher: a European dimension. *Information technology and training tools*. <http://www.ime.edu-ua.net>.
31. Project Lead the Way (2014). Today’s STEM ealities. URL: <http://www.pltw.org>.
32. Wang, D. & Zhang, X. (2018). Modeling of a 3D Temperature Field by Integrating a Physics-Specific Model and Spatiotemporal Stochastic Processes. *Appl. Sci.* № 9.
33. Slipukhina, I. A., Gedenach, T. V. & Olkhovyk V. V. (2017). Creating an informational website for physics academic course: web design specifics. *Information technology and training tools*. Kiev: IIITZN NAPS of Ukraine, T. 62, No. 6, 192-202 [in Ukrainian].
34. Eliseev, M., Tomchinskaya, T., Lipenkov, A. & Blinov, A. (2017) Using 3D-modeling Technologies to Increase Road Safety. *Transportation Research Procedia*, 20, 171-179.

Ayta Sakun

Doctor of Philosophy, Associate Professor,

Head of the Department of Philosophy, Political Science and Ukrainian Studies

Kyiv National University of Technology and Design

orcid.org/0000-0003-2340-3366

Tatiana Kadlubovych

Candidate of Political Sciences, Associate Professor,

Associate Professor at the Department of Philosophy, Political Science and Ukrainian Studies

Kyiv National University of Technology and Design

orcid.org/0000-0003-2021-2070

Daryna Chernyak

Candidate of Sociological Sciences, Associate Professor,

Associate Professor at the Department of Philosophy, Political Science and Ukrainian Studies

Kyiv National University of Technology and Design

Kyiv, Ukraine

orcid.org/0000-0002-1515-6070

ANTICIPATION OF THE LIFE PERSPECTIVE OF YOUTH IN THE CONTEXT OF THE NOTIONAL DIMENSION OF MODERNITY

Abstract. *The article analyzes the semantic dimension of modernity in the processes of sociality. It is shown how the change of meanings occurred as the main condition for the transformation of modernity, revealed the main directions of criticism of the Modernist project, analyzed the discourse of “modernity” from the point of view of the synergistic approach. The analysis of the problem of life prospects of the individual is carried out. It is established that the important role in the realization of desires and defining the life path of the individual is played by anticipation, that is the creation of a mental model of the future life scenario. The contents of such concepts as “life path”, “life strategy”, “life perspective” are revealed. A life perspective emerges as a holistic picture of the future, a potential opportunity for development, which is formed in the interconnection of expected and planned events in the unity of value-meaningful, motivational and organizational and activity aspects. In the course of the research, students' perceptions of life prospects and the values that determine the activity of youth in today's “knowledge society” were analyzed. It is established that the social world, which exists in the form of information civilization and has high rates of change, offers modern people many opportunities and variability of choosing their own life scenario, and therefore the anticipation of life strategy can take different directions.*

Introduction

The study of science, politics, education, culture and other spheres of human social life actualizes the problem of “modernity”, which arises in two aspects. First of all, modernity is commensurate with freedom of judgment, independent choice, autonomy with respect to established traditions, the dominant influence of social and political institutions. Dynamism, mobility, rationality, activity as attributive traits of modernity, ultimately arise from this freedom. At the same time, modernity presents itself with a set of rigid standards, the failure of which leads to loss of social and cultural status.

Today, philosophy is entirely focused on the modernity, where science with its innovative technologies is leading. As a result, we can state that way of thinking that “does not allow things to be”, and seeks to transform things or “conquer to our goals” [16, p.6].

Undoubtedly, the decisive role in the formation of a new way of thinking belongs to social studies, which determines the main directions of becoming of modernity. According to this, attention should be paid to the development of scientific social sciences and structures of social reproduction of postindustrial societies, which are impossible without quality science as the basis of prosperity and progress. The development of scientific structures and their incorporation into the industrial, economic and legal spheres leads to the deindividualization of social life, since connections and standards that make up the abstract-social qualities of people are beginning to dominate in these spheres and, according to this, “sacrifice” their individuality. There are clear differences between the formal, social and private individual lives of people.

One should consider that the practical need to solve contemporary problems indicates that the unity of social and humanitarian, ie social and philosophical knowledge is determined not so much by the standards of knowledge, but by the common problems that people face in their common and individual life, the interconnection of global issues and the tasks of self-realization of individuals, including the definition of life prospects. The main tendency of today is recognition of modernity as a “knowledge society”, emphasis on the role of knowledge as a major cultural asset, intellectual stock, potential for action in obligatory correlation with information.

The relevance of the study is due to the need to show the dependence of modernity on the realization of life prospects of individuals, their self-realization. Systematic and synergistic approaches, survey method, document analysis method were used while writing this paper.

1. Significant dimension of modernity in processes of sociality

Large subsystems of society such as production, law, education, science, politics, culture are focused on the use and multiplication of formal and social aspects of individuals’ being. Their private-individual lives find themselves on the "other side" of rigid social structures, but remain in the "field" of social science (philosophy) due to ideas that are not subject to the standards of abstract science and formal sociality, as well as beyond the scientific reflection of life, traditional culture and religiosity. [16, p.6-7].

A decisive influence on the problem of modernity is exercised by a scientific approach that conceptualizes the social and philosophical sciences in general. Growing from a certain social and practical basis, they express and explain its structure: subjects and methods of discipline "follow" the logic of reproducible social connections, capture the dominant types of activity, then complementing, ultimately delineating their delimitation and interconnections. While comparing and contrasting the disciplines of the scientific explanation of reality, practical differences between the forms of social connections and types of activities of people are expressed, which characterize the present (modern) state of life of man and society. Identification of the subject matter of the scientific nature of the disciplines, social and philosophical nature by which modernity is determined, is not only a consequence of the conscious methodological work of thinkers and scientists, but also the result of the reproduction of a certain structure of sociality (“logic of things”). Philosophy, in search of a universal instrument of knowledge of the world and man, abstracts from its internal features, appealing to the universal power of mind (spirit). Psychology, fixing the subject of his special research, begins with the elements of the human psyche, abstracted from the substantive-meaningful aspects of its activity. As a result, human subjectivity is considered in terms of spontaneity, not conditioned by the facts of modern social interactions. Social philosophy and politics in this situation seeks to identify objective “mechanisms” of social interactions, thereby “considering the influence of individuals on social structures, forms of self-realization and self-affirmation of individuals in society as minor” [16, p.7].

It should be noted that the scientific approach involves the creation of relevant theories. Thus, the classical modernization of theory over time begins to encounter circumstances that it is unable to explain and predict, and therefore to convert into facts within its theoretical framework. It is built using “ideal types” (M. Weber), or theoretical constructs. Classical modernization theory uses the terms of common language, but gives them a conceptual meaning. Traditional and modern societies appear in it as “ideal types”. When working with such constructs, which represent the most essential characteristics of the societies under consideration, it is impossible to ontologize “ideal types”, and to take them for reality. They act as methodological regulations aimed at understanding the societal distinctions of the essential parameters, referring to the logic of transition, the drama of which is evident precisely through the opposite traits of traditional and contemporary societies, rather than through ethical considerations. The post-evolutionist and post-progressive theories that emerge today respond to the experience of the unsuccessful application of a previous scientific approach, emphasizing changes in the vision of development – its non-linearity, unpredictability, probabilistic nature due to the emergence of a “globalization – a new megatrend” [34]. It further complicates the process of modernity as a process of development.

It is clear that the classical understanding of modernization is extremely rational, it requires mutual harmonization of all the parameters that change in the transition from traditional to modern society. In particular, the basis of modern discourse distinguishes two approaches: the concept of “freedom” must be replaced by the concept of “good”; the concept of “individual rights” must be superseded by the concept of “group rights”. The first aspect stems from the fact that one who cannot turn freedom into a good is willing to admit that he is not worthy of freedom, nevertheless he wants to have good things and insists on it. The second thesis is that those who claim for good are usually certain groups – ethnic, national, religious, linguistic. These groups differ greatly in their collective perceptions and culture from the middle class, that has entered into a social contract, has a similar understanding of morality and lifestyle, accounting for the majority of countries. The main social good include the classes of things necessary for the implementation of any rational life plan. These include both fundamental rights and freedoms, as well as profit, prosperity, the opportunity to realize oneself, social preconditions for self-respect of people. [34, p.15]. The polyphonic complexity of the social process determines the level of modernity, which is characterized not only by the “spontaneous logic” of the division of labor. From the standpoint of such logic, the opposite aspects of social reproduction emerge, which are ontologized, transformed into special objects, which are then considered in their totality, as social reality (“people's lives”), originating from the scientific analysis of the present. An example of such an analysis of the present is the attempt of V. Dilthey to justify the specifics of social science as opposed to naturalistic directed cognition. Orientation to the description of social and historical phenomena and events in their specificity, integrity, individuality are based on modern methodological procedures that determine the new priorities of life. Through them, the principle of “mutually exclusive complementarity” is substantiated [16], which has identified a new humanitarian science that finds its concentrated expression in social and humanitarian knowledge, primarily in philosophy.

It should be considered that the practical need to solve contemporary problems indicates that the unity of social and humanitarian, that is, social and philosophical knowledge is determined not so much by the standards of cognition, but by the common problems facing people in their common and individual life, the interconnectedness of issues and the tasks of self-realization of individuals. It thus outlines the new philosophical integration of the social sciences and humanities, together with its rethinking of their everyday foundations, their history and perspectives, their connection with the practice of society, their commensurability with science and sociality in the context of the present.

It should be noted that the term “modernity” is used to capture the actual reality. In scientific discourses, “modernity” is manifested through “the ambivalent meaning of modernity and even more so through its conceptual critique in postmodern discourse” [25], as S. Proleev points out. The set of connotations that accompany the term “modernity” and its derivatives make its use without clear definitions of its application. But when such concretisation is applied, the problem arises: “one or another sense of “modernity” determines the corresponding theoretical optics; after all, it provides the choice in favor of a diagnosis of the existing state of affairs and the development of humanity” [25].

A certain semantic orientation with respect to the reality that becomes the object of analysis is necessarily included in the preconditions of the analysis itself, forming its semantic horizon. However, one must refrain from conceptually defined verdicts about the present so as not to be in a situation where the result precedes the process of obtaining it. A relatively neutral position should be taken to help focus on the social characteristics that it (the situation) contains. On this basis, it is necessary to point to the change of meanings as the main condition for the transformation of the present. In particular, it is a matter of essential criticism of the Modern (Enlightenment) project and its refutation, which was carried out in three main directions. The theoretical substantiation of the former is carried out by T. Adorno and M. Gorkheimer, who have shown self-denial and self-destruction, which the Enlightenment contains. [2]. The principle of domination over nature, continued and entrenched by the dominance of man over himself, leads to environmental and social crises. If the ecological crisis is connected with the uncontrolled industrialization, which undermines the foundations of self-reproduction of man as a living being, then the social is perceived “in the domination of totalitarian regimes with their inherent use of social technologies of domination and total mobilization” [25, p.161].

In relation to the second, it emphasizes the internal crisis of legitimacy of social practices, and first of all – the production of knowledge, in the conditions of scientific and technological revolution and the social changes caused by it. This critique clearly manifested itself in the postmodern discourse made by the famous French philosopher J.-F. Lyotard [19]. From his point of view, modernity actually contains a rewriting of cultural codes, resulting in a loss of “trust in meta-stories” [19, p.10], and the role of social actors (subjects) with a shared sense of self-determination ceases to exist. And the third direction of criticism of the modernist (Enlightenment) project is directed against the latter's claim to universality. In contrast, it promotes the principle of the cultural and civilizational diversity of humanity, whose social existence and life cannot be reduced to certain unified structures. The latter involves taking into account contextual (local) experience, identifying in it a particular model that can be applied everywhere; showing that the highest achievements of a particular culture or group symbolically or in fact appear to be the achievements of mankind; it is argued that in experience with one context one can see something to understand the other experience. In this connection, P. Berger wrote: “... discipline that seeks to understand the modernity in essence must be inevitably corporate... one must look at Japan to understand the West, at socialism, to understand capitalism, at India, to understand Brazil, etc. [38, p.17]. Although on the basis of post-modern discourse, it is extremely difficult to achieve universality.

These critical discourses, focused on the problematic and meaningful "field" of human existence in the context of the “Modernist project”, point to the limitations of the previous social and humanitarian knowledge installations and its integration on the principle of “mutually exclusive interdependence”. The dependence of these attitudes on the practice of reproducing society as a “large structure”, within and against which the lives of social individuals are realized, is becoming

increasingly apparent. The unproductive social and methodological concepts that actually identify “sociality” with “structurality” appear to be obvious, leading to the neglect of the present. Therefore, in the interpretation of social systems of the modernity, the problem of their formation and change comes to the fore – both in the aspect of shaping the quality of life of an individual society, and in the aspect of the systematic design of the bonds of the human community. The need to show the dependence of the present on the self-realization of individuals is becoming more and more urgent, which in turn is caused by the development of science and technological progress. As a result, understanding the interconnected individual life of people becomes the “core” of understanding the changing modernity.

An important principle of this approach is to take into account the practical incentives that go beyond stereotypes that contrast the common and individual, social and personal, economics and psychology, structures and people. From this point of view, the analysis of the crisis situation of the modernity, in particular the “Modernist project” (Enlightenment), reveals two stages: a) the stage of formation, when a structure was formed that combined methodological dualism with integration in the form of “mutually exclusive interdependence”; b) a stage where this structure disintegrates, losing connections with everyday practice, destroying its own conceptions of sociality as the content of the present in its orders and functions. Thus, it is possible and necessary to speak about the completion of a certain stage of evolution of social and humanitarian knowledge related to the dominance of a particular type of structural and extensive sociality. Its advantage in everyday life, in the forms of large structures (spheres, industries, technologies) of society, in theoretical and methodological knowledge of its great theories (“narratives”), reductions, functions, determinations, etc., which have led to a new stage of modernity [16, p.8].

Although the previous stages (Modernist project) have not been completed, and the type of sociality, expressed by them, continues to operate, conserving the “energy” of large structures and narratives, but alongside and together other schemes that are included, “grow” into social and cultural practice, changing style of thinking. This trend is represented in a number of concepts: “human relations” (E. Mayo); “social action”, “communicative action” (J. Habermas); “structures” (E. Giddens); “constructing social reality” (P. Berger, T. Luckmann); “the social world” (A. Schutz); “world systems” (I. Wallerstein). They are joined by various schemes of dialogical and polylogical interactions, ideas about the quality of social life and activities that are embedded in projects and models of modern economics and politics, which convert into a personal and inter-individual plan of understanding the conditionality of modernity with knowledge and science.

All the above concepts, schools, directions are similar in one: they do not finish or rebuild previous traditional and classical concepts, but shift them to the “periphery” because they understand the concept of “modernity” in another dimension. Accepting the expediency of many critical invectives directed against the rational constructs of the Enlightenment (classical rationality) and partly the neoclassical era, it should be noted that the society of today does not appear in the form of a certain integrity, is not an example of social unity and economic unity. It is more a multifaceted social problem than it is a productive alternative to modern conceptualizations of sociality as the “ontological basis of modernity” [25, p.161]. However, despite the lack of universally recognized social models of existence of the global world, it is necessary to identify the general tendency that characterizes modernity as a “knowledge society” and, to the greatest extent, “the delegitimation of objective knowledge as a major cultural asset, and most importantly, its role as a universal means of self-attestation of reality in its relevance” [25, p.162], – emphasizes S. Proleev.

The urgency of such an understanding of modernity is explained by the fact that Modern time (the modern era) begins with the philosophy of F. Bacon, which convinces the power of nature-oriented knowledge, experienced science. But today there is a somewhat different understanding of knowledge, in particular “as a kind of intellectual stock (and stock of other valuable qualities of the individual), as a potential for activity, information, skills, abilities and other valuable qualities of the individual” [40, p.203]. The dominant characteristic of knowledge in its obligatory relation to information is indicated here.

Clear definitional and functional differences between the interconnected notions of “information” and “knowledge” emerged in the works of authors in the second half of the last century, when the concept of “information society” or a knowledge-based society began to emerge and comprehend. In particular, J.-F. Liotard wrote: “In the form of information goods needed to enhance production capacity, knowledge already is and will be the most important, and perhaps the most significant bet in the world power struggle.” [19, p.20]. In this context, “knowledge” and “information commodity” are identified, although they have not been commodities throughout the history of philosophy and science. Their “commodity existence” is a product of a later time.

The search for and explication of the concepts of “knowledge” and “information” in modern discourse shows that every short message can be called an “information atom” that is not fragmented. As a result, it does not contain a cognitive and epistemic form, and also loses its sense and meaning, each of the “information atoms” taken alone in relation to others, does not give rise to any action, operation or decision. “Information atoms” as elementary units of information define “the content received from the outside world in the process of our adaptation to it” as states N. Wiener. [27, p.84]. In order for a particular message to be regarded as a form of knowledge or knowledge in its own sense, it is necessary that certain actions or activities may be performed on the basis of that message. The latter refers to the set of system-interrelated unit actions (operations). Performed in a certain sequence, they form a reasonable (rational) activity. From this point of view, the ability to perform efficient reasonable activities based on this message is a decisive criterion that allows one or other message to be assigned to the knowledge class. On the contrary, “separate “information atoms” do not stimulate any activity, no targeted solutions” [27, p.84].

It can be concluded that the substantive differences between knowledge, forms of knowledge and information atoms are functional. This criterion for the difference between information and knowledge is rather conditional and relative. From the standpoint of another approach, one can assume that even elementary pieces of information provide some knowledge. But the cognitive-epistemic content of this unit is very limited. An important feature of knowledge is that on their basis it is possible to formulate a systematically organized sequence of rules that underlie a particular practice, a specific regulatory system that defines the contours of modernity, its order and rules. Knowledge is the cognitive foundation of social order and rules. It is important to emphasize that, based on this or that knowledge, both adequate and inadequate rules may emerge. The concepts of “information” and “knowledge” are crucial for modernity, the development of which is driven by scientific and technological progress and innovative technologies.

One should consider that information and knowledge, the development of which characterizes modern society, have both common features and significant differences. Forms of knowledge can act as certain matrices or abstract superstructures, and in strictly formalized form, as scientific theories. The knowledge system can be considered as a pragmatic matrix, which allows to formulate adequate rules and methods of activity that meet the requirements and needs of

modernity. Thus, based on the fact that today “human presence is traced in all disciplines, natural and social and humanitarian” [7, p.50], “temporal schools of projection of the development of the world for human physicality” are being constructed. [7, p.50]. Procedural or temporal-ontological human ontologies are conditioned by the fact that man is a social being, but one of his bases is natural and the other is cultural, communicative and creative, already formed in the new socio-cultural reality.

This situation contributes to the inclusion the synergistic approach in the understanding of the discourse of “modernity”. Synergetics are especially clearly manifested at the boundary of the transition between “bodies”, when social is born from the living, or from the action a practice emerges and from it – a cultural tradition. These transitions are dissipative structures in the flows of matter, energy, information, that is, they are described by the phenomena of self-organization of being. In today's “multi-temporal scales” activity-procedural ontology can help harmonize dialogue, communication of complex cultures and individuals. In addition, “the body of the culture of temporal ontologies becomes an analogue of the body of the psycho-mental in the ontology of states, and through it a person realizes his being, develops as a personality.” [7, p.51].

The characterization of “modernity” in the context of the role and significance of the factor “knowledge” raises the problem of the ratio of “risk” and “knowledge” in human activity. When considering knowledge as a prerequisite for social action, one must realize that risk is an inherent characteristic of social action. Knowledge and risk are interrelated aspects of the decision-making process within society. Specificity of risk-related decisions is the need to make choices among the options available in the uncertainty of the consequences, that is, in the context of incomplete knowledge. However, knowledge cannot, in principle, be complete; in pragmatic terms, it can be seen as complete in relation to the particular circumstances in which a decision is made. Making, implementing, and deploying consequences in space and in time affects a large number of social actors. In other words, risk today must be seen as a specific form of social communication, linked to the desire to “calculate” the progress of the present into an unknown future. [14, p.54].

From this point of view, modernity is emerging in a new dimension. As N. Luman emphasizes, risk is characterized by a set of “stages of contingency realization”, that is, uneven spatio-temporal distribution of random factors that influence the process of “decision making, advantages and disadvantages of a particular action, probability or improbability of the reality of losses as a result of a decision” [39, c.49]. This provides the basis for interpreting risk as a social construct whose value varies and is closely linked to specific social contexts and goals. Such an interpretation of risk emphasizes its communicative nature. The intertwining of the natural and social, objective and subjective, past, present and future in dealing with the risk of communication processes is characterized by increasing complexity. Within communication risks, synergistic nonlinear interactions occur, and local events in the context of globalization and accelerated development of information and communication technologies are increasingly causing global risk communication. Finally, the perception of risk by social actors as the most important element of communication ensures the inversion of one risk into another, and is also an important prerequisite for increased risk reproduction [14, c.54]. All this characterizes the present as a complex state, as a process, as a new reality.

The prerequisites for the emergence of a new reality are interconnected with the growth of scientific knowledge and the expansion of scientific and technical and technological activities as the most important factor in determining the parameters of modernity. Science and knowledge, in fact,

determined the direction of human development and at the same time acted as one of the most important factors contributing to the increase of uncertainty of the future. In the context of social transformations, which can be interpreted simultaneously and as the formation of a “knowledge society”, science receives a number of new qualities and functions. In particular, representatives of the Starnberg Group, German sociologists G. Bohme, P. Weingart, and V. Kron developed the concept of “finalization of science”. Its essence lies in the fact that the goals of scientific research are increasingly determined not by intrinsically scientific, but by external social and political goals, which causes the emergence of “hybrid communities”. They are "organizational structures in which scientists, policy makers, administrators, and industry representatives and other interest groups are directly involved to identify a problem, research strategy, and find solutions. This includes the process of translating political goals into technical goals and research strategies that combine different discursive universes.” [14, c.54-55]. Thus, the emergence of new institutional structures testifies to the diffusion of science, society policy as a characteristic of modernity.

An important characteristic of qualitative transformations of the present is the change in the relations between science and society. The result of these qualitative changes can be called “post-normal” science, bearing in mind the fundamental differences between T. Kun's “normal” science and the periods of scientific revolutions that he described. In addition, the end of the period of “normality” can also be said in the sense of exhaustion of traditional, “one-channel” relations between experts and politicians, when an integral part of the production of scientific knowledge becomes an account of its socio-political aspects. Under these conditions, previously stable demarcation lines between science, society and politics are gradually being erased, and there is a restructuring of the relationship between them, which has important consequences. The production of scientific knowledge is understood not so much as a search for the fundamental laws of nature, but rather as a process conditioned by the context of the application of knowledge, perceptions of social needs and potential consumers. According to V. Stepin, “the connection of scientific goals with non-scientific, social goals and values is explicated” [32, p.712]. The production of scientific knowledge becomes a reflexive process, a necessary element of which is the account of its social implications.

The reflexiveness of modern social life is the fact that social practices are constantly being researched and reformed in the context of the information on the same practices, which is changing as a result of their very foundations. Knowledge of how to "continue" development is an essential part of the agreements that are used and reproduced by human activity. In all cultures, social practices are changing daily as a result of their ever-changing discoveries. But “only in the age of modernity the revision of agreements becomes radical enough to cover (in principle) all aspects of human life, including technological intervention in the state of the material world” [8, p.158], – points out E. Giddens.

All these features of modernity are singled out as its main characteristic of knowledge, on the basis of which the idea of the "knowledge society" is conceptualized. But science itself, as a source of rationalization of socially significant decisions, simultaneously allows to understand the scope of uncertainty and, thus, expert knowledge. The value of expert knowledge begins to devalue. Any scientifically justified policy decisions can be challenged with the help of scientific analysis again. Therefore, the “knowledge society” has a serious potential for destabilization. However, the full potential of the idea of a “knowledge society” cannot be talked about until knowledge and information cease to be the most important factors in contemporary social change and economic

development.

The world of knowledge is not a world of social static and security. From the point of view of N. Ster, “modern societies are entities that are distinguished primarily by the fact that they produce their structures themselves, determine their future – and therefore have the capacity for self-destruction” [37, p.33]. These societies are “not unstable because they are “liberal democracies” but because they are “knowledge-based societies” [32, p.681]. Thus, modernity is determined by the knowledge that causes the problem of social transformations. However, this does not “remove” the problem of knowledge itself and knowledge based on it, beyond which neither science nor the development of society and man can be implemented.

2. Anticipation of the life perspective of modern youth

“The fate of each person is determined, first and foremost, by their own ability, to think and to reasonably treat everything that is happening in the world that surrounds them,” wrote E. Bern. [5, p.149]. In psychology, this understanding is denoted by the concepts of “life scenario”, “life path of the individual”, “life perspective”, “life strategy”, “lifestyle”, “concept of life”, “subjective picture of life path”, “personal life program”. Sociology uses the concepts of “life plans, programs, orientations”, “life perspective”. They are all used to denote a peculiar image of the future, created by the subject itself, which requires acting in a certain way, activates the need for recognition of the social environment and self-affirmation, and includes life plans, life program, life goals.

Creating the perspective of one's own life, dreams, planning, building a life strategy is the prerogative of the youth, since youth, according to the definition of psychologists, is a period in the life of a person, characterized by the “dominant of the future in the general structure of the subjective picture of the personal life path” [30, p.226].

The problem of life perspective of the individual was considered in various aspects: as a problem of life path (B. Ananiev, Ch. Buhler, S. Rubinstein), as a strategy of life (K. Abulkhanova-Slavska, Y. Reznik, E. Smirnov), as a construction of life perspective (K. Levin, J. Nutten) as a time perspective (E. Golovakha, O. Kronik) [24, p.22], as a “life scenario” (E. Berne), etc. A. Adler uses the concept of “lifestyle” and views it as an integrated style of adaptation to and interaction with life [22]. D. Leontiev understands life strategy as the ability of a person to create himself, his individual history, the ability to rethink his own essence [18]. In the works of L. Sohan [30, p.228] the strategy of human life is reflected by the concept of “life program of the individual”, which contains the main goals and results with which a person associates his own future. It is a strategy of activity and achievement.

Human life is first and foremost a story, but “... stories do not happen in real life, but rather they are constructed by people in their heads,” writes J. Bruner [6, p. 10]. “Stories about yourself and your life become a kind of semantic dominant, marking and organizing the path of life, directing self-constitution.” [33]. The idea of one's own life-changing world changes at every stage of society, because it is part of the worldview, world outlook. Defining the concept of the life path of the individual, B. Ananyev wrote: “the life path of a person is the history of the formation and development of personality in a certain society ...” [3, p.67]. A person has many opportunities and ways to choose his own life scenario in a democratic society, where the social world exists in the form of an information civilization and has a high rate of change.

Everyone has the right to choose their individual lifestyles, behaviors, the right to fulfill their own desires and preferences [30, p.40]. For this purpose a person is engaged in self-education and self-creation of one's own personality, programming one's life, anticipating and planning.

Therefore, in the construction of a life strategy, the concept of life, the leading role is played by anticipation, that is, the creation of a “thinking model (in the form of ideas) of those or other results that are expected” [20, p.40-41]. This phenomenon of anticipatory reflection provides a person with an opportunity to look into the future. Such an ability is possessed by a person who is able to independently develop his own life strategy, that is, to realize and determine the purpose of life, to choose the means to achieve it. L. Sohan believes that such a person is “characterized by a special arrangement of his own personality”, endowed with “the ability to life-building, the highest form of creative expression of man” [30, p.42]. Moreover, the life strategy reflects the “structure of life goals of the individual”, which is the “analogue of ... the vital system” of the person, his “consciousness, purpose, interests, desires and aspirations” [30, p.69]. T. Cottle emphasizes the role of anticipation in organizing human activity.

Considering the concept of the personal life path, K. Abulkhanova-Slavskaya distinguishes the concepts of “life strategy” and “life perspective”. The strategy of life is an integral characteristic of the personality, which arises “as the concept of life, as its meaning, the perfect plan” [1, p.5], “the ability of the individual to combine his own personality with the conditions of life, its reproduction and development” [1, p.129]. “It is a strategy of finding, justifying and realizing the individual by correlating the requirements of life with personal activity, values and self-affirmation” [1, p.128]. According to K. Albukhanova-Slavskaya [1, p.129], each personality has its own way of life, a way of its structuring, organization, evaluation and awareness.

Other authors define life strategy as “a dynamic system of perspective and long-term orientation of the person in the future life” [4], which includes social, cultural and personal orientations, which respectively determine the social position of the person, his cultural (generally accepted) and individual values. The main features of life strategies are the time length, reality, the ratio of positive and negative expectations, the structured future, the identification of certain “points” of perspectives of one's life [4].

L. Sohan thinks that creating a life strategy, concept of life, value orientations are a need of the individual [30, p.222]. The life strategy of the individual changes depending on the social situations in which it finds itself, because there is a rethinking of those values that are the motivators of her activities.

The concept of “life strategy” is a kind of planning a person's life according to their own values, it is a search for oneself [1, p.36].

The concept of “life perspective” is interpreted by K. Albukhanova-Slavskaya as a set of “psychological”, “personal” and “life”. Psychological perspective is a cognitive ability that provides a person with the opportunity to predict the future, to predict and shape his image, to imagine himself in it. Personal perspective is not only the cognitive ability to predict the future, but also a holistic readiness for it, the setting for the future, which is an indicator of the maturity of the individual, the potential for its development. The life perspective is the potential, the possibilities of the individual, the “life position”, “which determines the future of the individual” [1, p.77]. K. Levin considered life's perspective as an individual's view of his psychological future and past [17, p.198-199].

“Life perspective is a holistic picture of the future, formed in a complex contradictory relationship of expected and planned events, considered in the unity of value-meaning and organizational-activity aspects, where the activity of personality, conscious and realistic attitude to making plans for future are essential” [13, p.318]. “Life perspective” is a concept that emphasizes

the motivational aspect of life, when the picture of the future is drawn “in the complex contradictory relationship of programmed and expected events, with which a person associates the social value and individual meaning of his life” [31, p.210]. A life perspective is a potential opportunity for personal development.

Life perspective planning is one of the components of self-determination that involves the motives of the individual and his or her values. If the motive is an “affectively” charged “anticipational target state (the idea of the desired result of action: to do something better, to influence someone, etc.), which is actualized under the influence of various stimuli ..., the interest in the target condition, which is repeated periodically ...” [21, p.15], it can be assumed that the creation of a life-long perspective is a theoretical anticipational process of “reconciliation of events and expectations”, “expectations and real” [21, p.197]. J. Kelly believes that a person “looks at the world through transparent stencils or templates” [15, p.7], without which it would be very difficult to navigate in the world. These patterns are called by the scientist as constructs which, in his opinion, help to “build a line of behavior” and to present “a specific meaning of one's life”. “Each person formulates in his own way the constructs by which he tries to anticipate and control the course of events in his life,” says J. Kelly. [15]. In other words, the construct is a representation of a world of high degree of abstraction created by man. Personal constructs are used to predict events, understand the system of phenomena and help to understand the anticipating nature of human behavior, its use of hypotheses in thinking.

Anticipation of the subjective picture of life path, life perspective is also based on personal values. “The value orientation of the individual affects both the content and structural characteristics of the subjective picture of the life path” [36, p.248-249]. Planning one's future, planning specific events, one proceeds from a certain hierarchy of values that exists in one's mind and selects the ones that are most closely related to one's dominant needs. Therefore, life's self-determination can be regarded as “value-meaningful” [9].

3. Student youth's perception of a life perspective

The path of life is created by the person himself and is connected with the awareness of the purpose and meaning of his whole life. According to L. Sohan, the way of life is a process of self-realization of the individual [30, p.121]. Psychological past, present and future, whose unity is temporal integrity, are the components of life perspective. [35, p.345].

Today's youth create their own life strategies, life prospects, focusing on success and progress, which become clear guidelines and the basis for future relationships.

The aim of the study was to find out what life strategy is chosen by the representatives of the modern young generation, how they build their own life prospects and what life path is ideal for them. The basis for the research was the exercise on psychological training of creativity “Four ages”, proposed by A. Gretsov [12, p.184-185]. Using A. Gretsov's statement that “exercise creates preconditions for awareness and reflection on one's life path” [12, p.184], a questionnaire was developed in which the questions “What is the most important for a person?”, “What makes him “happy?”, “What makes him successful?”, “What unique opportunities does he have?” Each of these questions had to be designed for a “child”, “teenager”, “adult” and “elderly” person.

Thus, students created their own subjective picture of the life path, expressed by constructions of a high degree of abstraction.

138 respondents – students of 1 year of one of the technical institutions of higher education of Ukraine participated in the survey.

Qualitative and quantitative analysis of respondents' answers was used in the processing of the questionnaires. Answers to the question "What is most important for a person?" were obtained that reflect the leading human needs at one or another age, as described in the scientific literature.

Thus, the scientific literature [26, p.144-145] states that the child's leading need is the need for communication, the exchange of emotions between the child and adults, the need for adult care. 58.7% of the answers (81 people) are the answers: "Parents, complete and happy family, relatives". Another 58.7% (81 people) said: "Care, attention, warmth, kindness, love, attention, help." 44 students (31.9%) consider that the most important thing in childhood is "toys, games, fun, play, fun, entertainment", which is also in line with scientific research [26, p.145-147], as "the leading activity in childhood is a game in which the child actively "absorbs the riches of the world". In the course of the game, the child acquires the norms of social life, learns the basic functions of people, the primary self-knowledge occurs. The game creates a "zone of immediate development" (L. Vygotsky), on the basis of which readiness for learning activities is formed" [26, p.145-147]. "Knowledge acquisition and cognition of the world, cognition, development" such were the answers of 20 students (14.5%).

Leading need of the teenager is communication with peers, friendly relations with the environment [26, p.147-149]. Therefore, the answers "friends, friendship, communication, relationships, love, place in the company, society, collective, recognition, understanding" were provided by 47.1% of the respondents that is 65 students. The leading activity at this age is education, 31 respondents answered "education, knowledge, cognition", which is 22.5%. And the answer "personality formation, self-development, self-knowledge, self-realization, development, social development" is found only in 12.3% (in 17 people). As we can see, these percentages are quite low. According to the team of authors, they can be explained by the fact that modern youth do not see problems in finding information, since it can always be found, only access to the Internet is needed. The only problem is that the information you need to be able to find, and this already depends on the developed skill "be able to learn".

The most important thing for an adult is to start a family and acquire skill and professionalism [26, p.149-150]. Such responses are observed in the students' answers. 54.3% of respondents (75 people) answered "family, children" and 22.5% (32 students) answered "job, career". Also important are the answers "money, earnings, wealth" (20.3%, or 28 people), which may also indicate professional personality traits, since the high level of professionalism is the high earnings.

For the elderly, the most important in life, according to the survey participants are "health" (26.8% – 37 students) and "family" (37 students – 26.8%).

The second question "What makes a person happy?" gave us the following results. Children are happy with "toys, games, entertainment, fun, cartoons, etc." (56.5%) and "parents, mom, dad, their love, attention and care, family" (47.1%). Happiness for a teenager is "friends, communication, first feelings (love)" (47,8%). According to the respondents, an adult becomes happy when he or she has a "happy strong family" (35.5%), is well-off financially (19.6%) and has a job (12.3%). For the elderly, happiness is "a big happy family" (33.3%), "children and grandchildren" (18.8%) and "care, attention" (12,3%).

Students' perceptions of success in life reflect answers to the question "What makes a person successful?" According to the respondents, the success for the child is "their own achievements: win the game, play at the kindergarten, etc.", "elementary skills (to walk, draw, speak, read, write)",

“learning success”, “the first good, self-made , affairs», “championship in little things”, “learning, cognition, knowledge, new discoveries, development” (69,6%). The success of a teenager is determined by the following categories: “learning, education, cognition”, “achievement at school, university, in teaching, sports, art” (39,1%). According to the respondents, an adult will be successful when he has “a good (stable, high-paying, favorite) job, career, business” (45.7%), as well as “wealth, high income (salary), money, prosperity, well-being, providing for yourself and your family, financial independence, financial status” (23,9%). The elderly is successful when they have the wisdom and experience of life (13.8%). These answers were most frequently encountered. The success of an elderly person is a long-term prospect, and that's why not everyone thinks about it.

The unique capabilities of the child are “carelessness”, “lack of responsibility and duties”, “doing whatever they want” (34%). “Discovering the world for yourself, learning new, being able to develop” (22.5%) are unique opportunities for a teenager. Life-long anticipation enabled respondents to point out the unique capabilities of an adult. They became “self-determination and independence” (17.4%), “family; their placement and provision, family care” (15.9%), “work, business, career” (13%), as well as “money and security” (7.97%). “Great experience”, “wisdom” and the opportunity to “share, give wise advice, learn” are such unique opportunities for the elderly, said 44.9% of respondents.

Thus, studying the anticipation of life prospects of modern youth has shown that students are committed to fruitful work in order to gain life and professional experience and to be able to share it with their happy family.

According to researchers (in particular, T. Reznik, Y. Reznik [29]), life strategy can take different directions: strategy of life well-being (receptive, “acquiring”), strategy of life success and strategy of life self-realization (creative). The strategy of vital well-being intensifies the efforts of the individual to acquire vital goods, accumulation, material well-being. The strategy of success in life is aimed at achieving success, depending on the idea of the person, based on motives and motivation. Creative orientation involves, first and foremost, self-realization, regardless of external recognition or non-recognition.

After analyzing the students' answers to all the questions concerning adults and the elderly (because these answers indicate a life perspective), the authors concluded that the directions of the respondents' life strategy are distributed as shown in Table. 1

Table. 1. Directing the life strategy

	Receptive direction		Motivational direction		Creative direction	
	adults	elderly	adults	elderly	adults	elderly
Question 1 “The most important thing in life”	31	12	48	2	20	23
Question 2 “What makes a person happy?”	52	1	28	2	7	14
Question 3 “What makes a person successful?”	98	7	41	23	29	43
Question 4 “Unique Features”	14	5	43	33	73	34

As shown in Table. 1, a person's views on his own life strategy depend on the question to which they answer. According to the respondents, the most important for the adult is the motivational direction (34.8%), the receptive direction (37.7% and 71% respectively) will bring happiness and success, and the creative direction (52.9%) will bring unique opportunities. The elderly will preferably have a creative direction of life perspective, as the answers to all questions showed. Thus, students' perceptions of life prospects are based on their perceptions of life values, priorities, meaning of life and success. A person realizes his place in it, envisages his life path, the meaning of his activity for himself and all humanity, plans and dreams by studying, cognizing the world, mastering professional competences. The life prospects of contemporary youth are diverse and varied.

Conclusions

The problem of "modernity" can and should be understood not only in the categories of plurality, but, importantly, it develops itself according to the laws of the synergistic nonequilibrium system, demonstrating the multiplicity of evolutionary vectors of development. A person, knowing the world, always understands his place in it and the importance of his activities for himself and all humanity in a new sense. These processes are variable and spontaneous, they include multidirectional, contradictory and mutually exclusive tendencies. The logic of their development does not obey the principles of classical determinism, the methods of dialectics, so it requires a more complex, cognitive approach, requires a new culture of thinking. This situation is due to the factor of globalization as the most important megatrend of the present.

The social world, which exists in the form of information civilization and has a high rate of change, offers modern people many opportunities and variability of choosing their own life scenario.

An important role in the realization of desires and the definition of the path of life is played by anticipation – the creation of a mental model of the future life scenario. Anticipating abilities are a necessary element of regulation of activity, behavior and emotional states of a person, they participate in processes of adaptation of the person to changing environmental conditions and help in building a life perspective.

The life perspective emerges as a holistic picture of the future, a potential opportunity for development that is formed in the interconnection of expected and planned events in the unity of value-meaning, motivation and organizational-activity aspects. Since the anticipation of a life-long perspective is based on personal values, it was appropriate to find out which ones are determinative for modern student youth. Thus, in the course of the research it was found that the basic values that determine the activity and actions of young people and, accordingly, are the desirable life prospects are: a happy, full family, dominated by love, mutual respect, mutual support and care; work that allows you to self-actualize, show professionalism, grow, have good earnings; well-being that will enable them to fulfill their vital needs and be independent; health; wisdom and life experience as an opportunity to transmit knowledge, to realize oneself in children, students and followers.

It has been found that the anticipation of a life strategy can take different directions: a strategy of life well-being (receptive, "acquiring"), a strategy of life success and a strategy of life self-realization (creative).

The crisis and unstable social situation in Ukraine escalates the problem of life-long anticipation, since it is difficult for individuals to project their own life paths, considering the uncertainty of social development prospects.

Anticipation, the construction of a life strategy is part of the emergence of a new reality, and therefore should be based on scientific knowledge as the most important factor in determining the parameters of modernity. Science and knowledge determine the direction of human development and is one of the most important factors contributing to the uncertainty of the future.

References

1. Abul'khanova-Slavskaya, K.A. (1991). *Strategiya zhizni*. M. : Mysl'.
2. Adorno, T. (1997). *Dialektika Prosveshcheniya*. M.: SPb.: Yuventa.
3. Anan'ev, V. G. (1980). *Chelovek kak predmet poznaniya, Izbr. psikholog. trudy* (T.1.). M. : Pedagogika.
4. Bekurina, Y.S. (2018). *Zhiznennyye strategii molodezhi kak teoreticheskiy kontsept: nauchnye i filosofskie refleksii*. Retrieved from <http://publishing-vak.ru/file/archive-philosophy-2018-4/4-bekurina.pdf>
5. Bern, Erik. (1996). *Igry, v kotorye igrayut lyudi : Psikhologiya chelovecheskikh vzaimootnosheniy ; Lyudi, kotorye igrayut v igry : Psikhologiya chelovecheskoy sud'by*. [SPb.] : Spets. lit.
6. Bruner, Dzh. (2005). Zhizn' kak narrativ *Postneklassicheskaya psikhologiya*, 1, 9-30.
7. Budanov, V. G. (2012). Postneklassicheskie praktiki i kvantovo-sinergeticheskaya antropologiya. V. G. Budanov, *Postneklassicheskie praktiki: opyt kontseptualizatsii*. (p. 37-62). SPb.: Izdatel'skiy dom «Mir»
8. Giddens, E. (2011). *Posledstviya sovremennosti*. M.: «Praksis».
9. Ginzburg, M. R. (1988). Lichnostnoe samoopredelenie kak psikhologicheskaya problema. *Voprosy psikhologii*, 2, 19-26.
10. Golovakha, E. I. (2001). Zhiznennyye perspektivy i tsennostnyye orientatsii lichnosti. L. V. Kulikova (Sost. i obshch. red.), *Psikhologiya lichnosti v trudakh otechestvennykh psikhologov*. (c. 256-269). SPb.: Piter.
11. Golovakha, E. I. (2008). *Psikhologicheskoe vremya lichnosti*. M. : Smysl.
12. Gretsov, A. G. (2008). *Trening kreativnosti dlya starsheklassnikov i studentov*. SPb.: Piter.
13. Guljas, I. A. (2011). Zhyttjeva perspektyva osobystosti jak predmet teoretyko-metodologichnogo analizu. *Problemy suchasnoi' psyhologii'*, 12, 315-324.
14. Efremenko, D. V. (2010). Konceptiya obshhestva znaniya kak teorija social'nyh transformacij: dostizhenie i problemy. *Voprosy filosofii*, 1, 49-61.
15. Kelli, Dzhordzh A. (2000) *Teorija lichnosti : Psihologija lichnykh konstruktov*. SPb. : Rech'.
16. Kemerov, V. E. (1999). Konceptiya radikal'noj social'nosti. *Voprosy filosofii*, 7, 3-13.
17. Levin, K. (1992). Opredelenie ponjatija «pole v dannyj moment». P. Ja. Gal'perin, L. I. Zhdan (Red.), *Istorija psyhologii (10-e-30-e gg. Period otkrytogo krizisa): Teksty*. (2-e izd.). (c. 190-204). M.: Izd-vo Mosk. un-ta.
18. Leont'ev, D. A. (1996). Ot social'nyh cennostej k lichnostnym: sociogenenez i fenomenologija cennostnoj reguljatsii dejatel'nosti. *Vestnik Moskovskogo universiteta. Serija 14: Psihologija*, 4, 35-44.
19. Liotar, Zh.-F. (1998). *Sostojanie postmoderna*. M.: Institut jeksperimental'noj sociologii, SPb.: Aletejja.

20. Lomov, B. F. (1980). *Anticipacija v strukture dejatel'nosti*. M. : Nauka.
21. Makklelland, D. (2007) *Motivacija cheloveka*. SPb.: Piter.
22. Osipova L. B., Jenveri L. A. (2016) *Zhiznennye strategii molodezhi: opyt sociologicheskogo issledovanija*. Retrieved from <https://cyberleninka.ru/article/n/zhiznennye-strategii-molodezhi-opyt-sotsiologicheskogo-issledovaniya>
23. *Osnovnye podhody k issledovaniju zhiznennyh strategij lichnosti* (2010). Retrieved from http://polga.pro/?page_id=173
24. Pyrog, G. V. (2018) *Zv'jazok zhyttjevyh strategij suchasnoi' molodi z psihologichnym vikom: teoretychni aspekty. Suchasni naukovy doslidzhennja v psihologii' ta pedagogici – progres majbutn'ogo : zbirnyk naukovykh robit uchasnykiv mizhnarodnoi' naukovy-praktychnoi' konferencii'*. Odesa : GO «Pivdenna fundacija pedagogiky», c. 22-25.
25. Prolejev, S. V. (2011). *Osvitnij proekt modernu ta suchasnyj universytet*. [avt. kol.: V.Andrushhenko (kerivnyk), M.Bojchenko, L.Gorbunova, V.Lutaj ta in.] *Filosofija i metodologija rozvytku vyshhoi' osvity Ukrai'ny v konteksti jevrointegracijnyh procesiv*. (c. 154-178). K.: Pedagogichna dumka.
26. *Psyhologija: Pidruchnyk*. (2008). (6-te vyd., stereotyp). K.: Lybid'.
27. Rakitov, A. I. (2005). *Reguljativnyj mir: znanie i obshhestvo, osnovannoe na znanijah. Voprosy filosofii*, 5, 82-93.
28. Ral'nikova, I. A. (2002) *Zhiznennye perspektivy lichnosti: psihologicheskij kontekst*. Barnaul : Izd-vo Alt. un-ta.
29. Reznik, T. E. (1995). *Zhiznennye strategii lichnosti. Cociologicheskie issledovanija*, 12, 100-105.
30. Sohan', L. V. (1987). *Zhiznennyj put' lichnosti (voprosy teorii i metodologii social'no-psihologicheskogo issledovanija)*. Kiev: Naukova dumka.
31. *Sociologija*. (1999). K. : Ukr. encykl.
32. Stepin, V. S. (2003). *Teoreticheskoe znanie*. M.: Progress-Tradicija.
33. Tytarenko, T. (2010). *Zhyttjevyj shljah osobystosti v postmodernists'komu dyskursi. Psyhologija osobystosti*, 1, 11-18.
34. Fedotova, V. G. (2002). *Neklassicheskie modernizacii i al'ternativy modernizacionnoj teorii. Voprosy filosofii*, 12, 3-21.
35. Havula, R. (2015). *Zhyttjeva perspektyva osobystosti v junac'komu vici. Aktual'ni pytannja gumanitarnykh nauk : mizhvuzivs'kyj zbirnyk naukovykh prac' molodyh uchenykh Drogobyc'kogo derzhavnogo pedagogichnogo universytetu imeni Ivana Franka*. Drogobych : Prosvit., 11, 343-348.
36. Shatyns'ka, O. P. (2013). *Vzajemovplyv systemy cinnostej osobystosti ta i'i' zhyttjevogo shljahu. Aktual'ni pytannja gumanitarnykh nauk : mizhvuzivs'kyj zbirnyk naukovykh prac' molodyh uchenykh Drogobyc'kogo derzhavnogo pedagogichnogo universytetu imeni Ivana Franka*. Drogobych : Prosvit., 6, II, 244-250.
37. Shter, N. (2002). *Mir iz znanija. Sociologicheskij zhurnal*, 2, 30-35.
38. Berger, P. (1992). *Sociology: a Disinvitation? Society*, 30, 14-22.
39. Luhman, N. (1991). *Soziologie des Risikos*. B. I. Y. de Qruyter.
40. Nyiri, L. (2002). *Knowledge-based society and its impact on Labour-market values. Society and economy*. Budapest, Vol. 24, 2, 201-210.

Alona Bekh

PhD Student, Taras Shevchenko National University of Kyiv

Kyiv, Ukraine

orcid.org/0000-0002-4561-9363

Olena Pryiatelchuk

Doctor of Economics, Associate Professor

Taras Shevchenko National University of Kyiv

Kyiv, Ukraine

orcid.org/0000-0002-5222-452X

AI-POWERED BUSINESS ACTIVITIES OF DIGITAL MEDIA COMPANIES IN TERMS OF KNOWLEDGE ECONOMY

Abstract. *In terms of knowledge economy, artificial intelligence (AI) is seen by modern companies as an engine of productivity and economic growth. AI turns out to be a game changer for business generally and digital media industry in particular. In this study the focus is made on the comprehensive overview of AI-powered business activities of leading companies, which produce digital media products. The efficient implementation of AI is equally important during different stages of digital media production: development, pre-production, production, post-production and distribution. AI is becoming a bigger and inherent part of day-to-day business, accelerating the path towards a proactive, predictive, automated and personalized future for all segments of digital media industry, specifically video-on-demand, digital music, e-publishing, video games and social media.*

Introduction

Currently, the most significant transformation in the competitive environment of digital media companies is the development of knowledge economy. The knowledge economy means the type of economy, in which the main driver of production and consumption is intellectual capital. This is an economy, which growth and competitiveness are ensured by the creation, dissemination and application of knowledge in the form of high-tech products and services. Traditional economic concepts based on the principle of extracting maximum possible benefits from limited resources, namely natural resources, labour resources and capital, are losing their applicability. Main resources of knowledge economy — information, data, knowledge etc. — are inexhaustible by their nature, they can be easily exchanged and significantly multiplied in the process of application.

In terms of knowledge economy, artificial intelligence (AI) is seen by digital media companies as an engine of productivity and economic growth. AI is often used as an umbrella term covering such technologies as machine learning, deep learning, predictive analytics, virtual assistants, natural language processing, computer vision, data mining, robotics etc. [6, p. 12]. The development of these technologies creates conditions for building completely new operational and business models. Companies are able to analyse data at levels beyond human comprehension and act immediately on the basis of received insights. This, in turn, allows companies to take a personalized approach to working with customers, develop products and services based on their needs and identify growth opportunities as quickly and accurately as never before. Netflix, Spotify or Amazon are classic examples of companies, which use accumulated data to create value through AI and machine learning. Due to breakthrough technologies of the 21st century, the approach of producing and distributing media content has changed significantly and business models in the media sector have been completely revised.

1. Literature Overview

In mid-1950s, computer scientist John McCarthy coined the term “artificial intelligence”, which he defined as “the science and engineering of making intelligent machines” [15]. As for up to date definition, in their book, “Artificial Intelligence: A Modern Approach”, computer scientists Stuart Russell and Peter Norvig define AI as “designing and building of intelligent agents that receive percepts from the environment and take actions that affect that environment” [26, p. 1]. The critical difference between AI and generalpurpose software consists in phrase “take action”. AI enables machines to respond on their own to external signals, namely signals that programmers do not directly control and, therefore, can’t anticipate. The fastest-growing category of AI is machine learning, which implies “programming computers to optimize a performance criterion using example data or past experience” [1, p. 3].

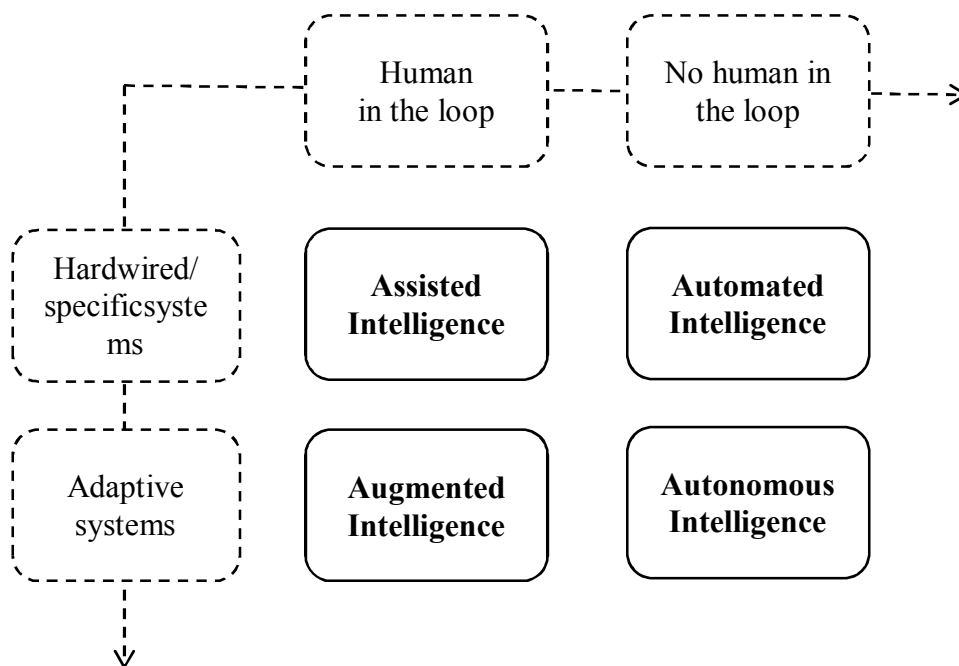

Fig. 1. AI Types

Source: [21, p. 2]

Depending on the human involvement in the work of AI, there are four types of AI (Figure 1):

1. Assisted intelligence, which improves the performance of existing activity.
2. Augmented intelligence, which gives new capability to human activity, permitting do things a human couldn't do before.
3. Automated intelligence, which automates the performance of certain tasks.
4. Autonomous intelligence, which involves automating decision making processes without human intervention [23].

AI expansion leads to positive impacts as well as negative ones (Figure 2). In 2016, several industry leaders, namely Apple, Amazon, DeepMind, Google, Facebook, IBM and Microsoft, joined together to create Partnership on AI (PAI) to shape best practices, research and public dialogue about AI's benefits for people and society. Now PAI represents a community of 50+ member organizations, including Accenture, BBC, Baidu, EY, Intel, PayPal, T-Mobile, Samsung and Sony [19].

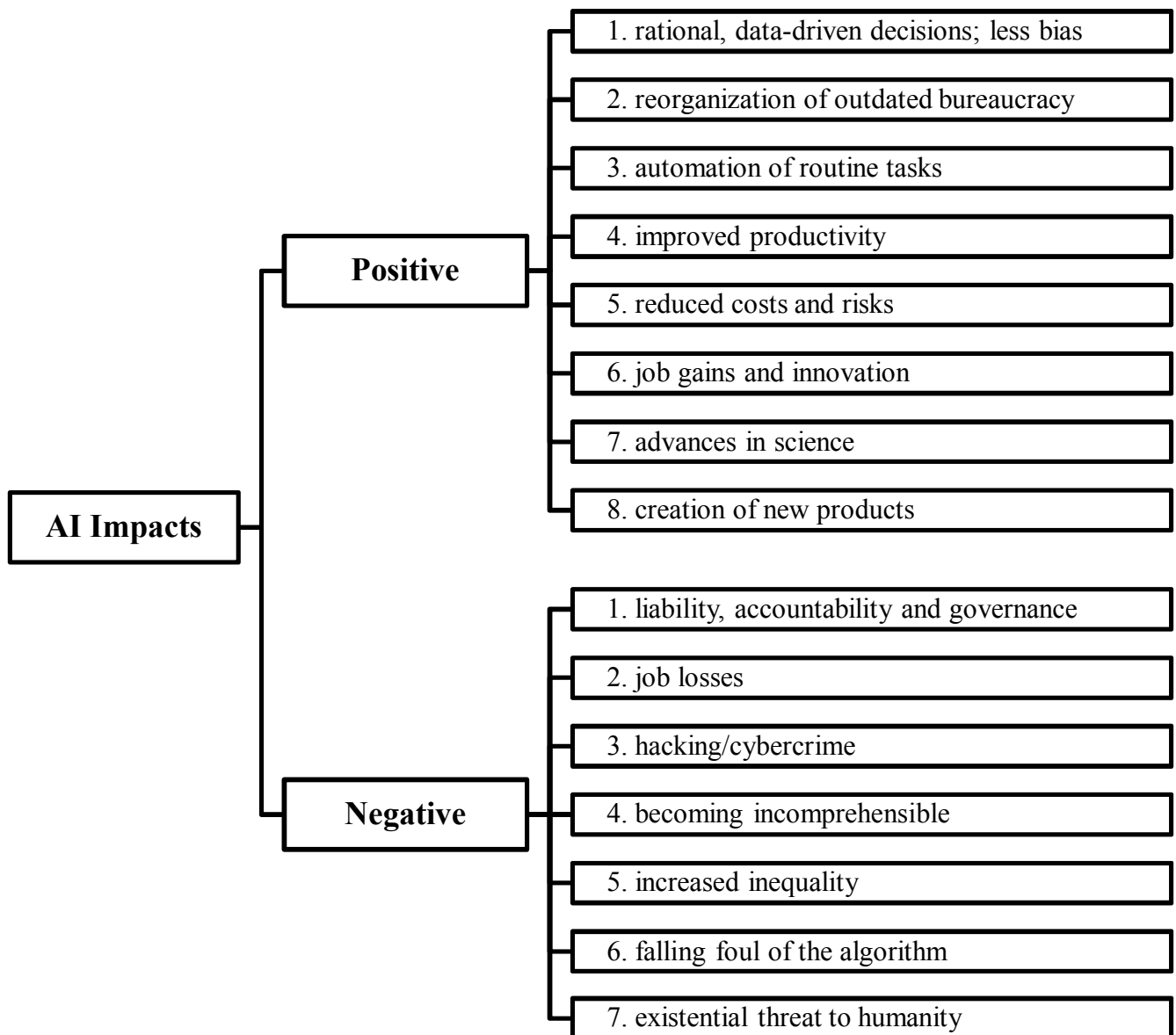

Fig. 2. AI Impacts.

Source: made by authors based on [10, p. 6-14; 27, p. 137]

The organization promotes the development of AI projects of any kind: some projects address deep societal challenges and are moonshots — ambitious big bets that could have far-reaching impacts; others may be creative ideas that could quickly produce positive results by harnessing AI advances.

The development of AI is a key factor of companies' enhanced performance in the context of knowledge economy and Industrial Revolution 4.0. Here's how Microsoft CEO Satya Nadella described the significance of AI for the future of modern companies: "The core currency of any business going forward will be the ability to convert their data into AI that drives competitive advantage" [9].

According to 2017 PwC report, AI could contribute up to \$15.7 trillion to the global economy in 2030, more than the current output of China and India combined. \$6.6 trillion of this contribution is likely to come from the improved productivity and \$9.1 trillion is likely to come from consumption-side effects [21, p. 5]. In 2019, the global private AI investment was over \$70

billion, with AI-related startup investments over \$37 billion, M&A —\$34 billion, IPOs —\$5 billion and minority stake valued around \$2 billion [29, p. 6].

There are a few institutions and organisations, which index different countries within the field of AI. At the present time, the most comprehensive index is developed and published by Tortoise Media. Their Global AI Index analyses how 54 countries are driving and adapting to accelerating development of AI through three pillars: investment, innovation and implementation (Table 1 and Figure 3).

The Global AI Index shows that there is a huge gap in AI development between the USA, China and other countries. The USA and China, where 37% of top world media companies are based (59 and 15 media companies respectively out of 200 top world media companies according to Statista [30]), show that the only sustainable response to technological disruption of AI is trying to lead it.

Table1. The Global AI Index by Tortoise Media

Countries	Implementation			Innovation		Investment		Total Rank
	Talent	Infrastructure	Operating Environment	Research	Development	Government Strategy	Commercial	
USA	100	100	80.4	100	89.4	68.5	100	100
China	15.8	93.1	89.4	52	100	100	34.4	58.3
United Kingdom	31.8	78.1	100	37.8	20	88.2	22.6	43.7
Canada	32.8	62.9	80.9	29.4	20.3	96.7	15.2	37
Germany	23.4	73.3	77.2	33.3	19.5	96.3	8.7	35.3
France	24.6	52.9	96.5	27.2	23	95.6	11	34.1
Singapore	41.8	85.9	36.2	24.5	18.6	30.4	12.8	33.3
South Korea	11.4	84.9	47.1	22.4	73.1	23.1	3.3	31.7
Japan	12.2	68.9	59.5	32.2	24	74.1	10.9	30.4
Ireland	29.3	98.7	48.2	20.1	27	3.8	4.4	30.4
Australia	21.8	51.7	76.4	23.5	46.4	7.4	7	29
Israel	18.8	47.5	21.1	32.7	29.6	0	33.1	28.1
Switzerland	21.8	71.1	28.7	31.7	19.2	36.6	7.7	27
Finland	15.7	77.3	37.6	28.3	17.4	55.8	5.4	26.6
Spain	15.7	75.3	58.4	17.9	14.6	83	3	26.1
The Netherlands	27.4	67.6	60.8	10.8	23.6	40.5	4.1	25.9
Denmark	16.9	66.6	51	26.4	15.9	39.5	4	24.9
India	33.7	37	58.5	20.4	19.4	38.5	6	24.9
Luxembourg	12.3	53	49.2	28.5	14.2	79.4	5.1	24.2
Sweden	17.4	57.5	58.6	29.1	15.4	3.5	5.2	23.7
Austria	12.6	69.8	46.9	23.4	16.8	48.3	2.7	23.6
New Zealand	18	63.2	73.8	24.7	4.7	0	2.6	22.8
Poland	8.5	58.6	60.1	20.3	6.4	98.3	2.4	22.4
Estonia	12.1	63.4	33.5	20.7	10.7	66.4	7.7	21.9

Hong Kong	14	81.7	26.4	22.5	0.6	37.6	5.7	21.5
Italy	9	60.5	58.9	19.4	15.5	37.1	2.2	20.9
United Arab Emirates	5.5	80.6	68.9	1.1	0	97.7	2.6	20.4
Norway	19	54.3	35.7	23.2	15.1	3.8	3.7	19.9
Saudi Arabia	6.1	72.3	59.5	24.4	0.3	9.2	0.4	19.3
Taiwan	8.2	73.4	11	18.7	5.4	61.1	4.1	18.2
Belgium	10.6	47.6	35.3	20.3	16.5	31.4	2.8	17.6
Malta	16.5	43.5	35.2	4.9	14.2	81.4	4.9	17.3
Russia	10.7	45.3	63.1	6	17.6	52.1	1	17.3
Czech Republic	6.7	56.3	30.1	24.5	3.1	52.5	1.8	17.3
Iceland	13.4	48.7	45.1	20.2	0	4	4.9	16.3
Mexico	3.3	35.6	85.9	15.2	5.7	39	0.7	16.2
Portugal	9.1	41.7	45	2.4	9.7	83.9	3.1	14.9
Lithuania	12.4	46.9	42.4	1.1	3.6	52.9	1.4	13.2
Qatar	2	67.4	48.6	0	0	44.5	0	12.7
Malaysia	8.8	50.8	60.8	2.6	0.2	0	0.7	11.9
Turkey	6.9	32.7	43.5	16.8	0.3	12.7	0.6	11.2
Uruguay	2.5	63.4	43.2	0.2	0	10.5	0.3	10.4
Morocco	3.6	52.8	54.2	0.1	0	0	0.1	9.7
Brazil	7.2	42.1	43.6	4.3	0.9	0	2.3	9.7
South Africa	2.7	44.2	51.6	1.6	5.3	4.8	0.5	9.5
Hungary	6.2	42.1	33.2	1.9	5.2	12.4	1.5	8.9
Argentina	4	40.4	53.5	1.1	3.7	0	0.6	8.9
Tunisia	7.9	44.6	31.1	0.4	0	13.2	0.3	8.2
Indonesia	3.3	22.5	60	1.7	0.2	0	3	7.1
Kenya	1.5	18.3	24.1	0.2	14.2	0	0.4	3.9
Sri Lanka	1.4	28.2	1.5	0.5	0	10.5	0.1	1.7
Nigeria	0	0	47.8	0.1	0	9.2	0.3	1.6
Egypt	2	17.3	6.6	1.6	0	0	0.3	0.6
Pakistan	1.9	16.7	0	1.4	0	3.1	0.1	0

Source: [32]

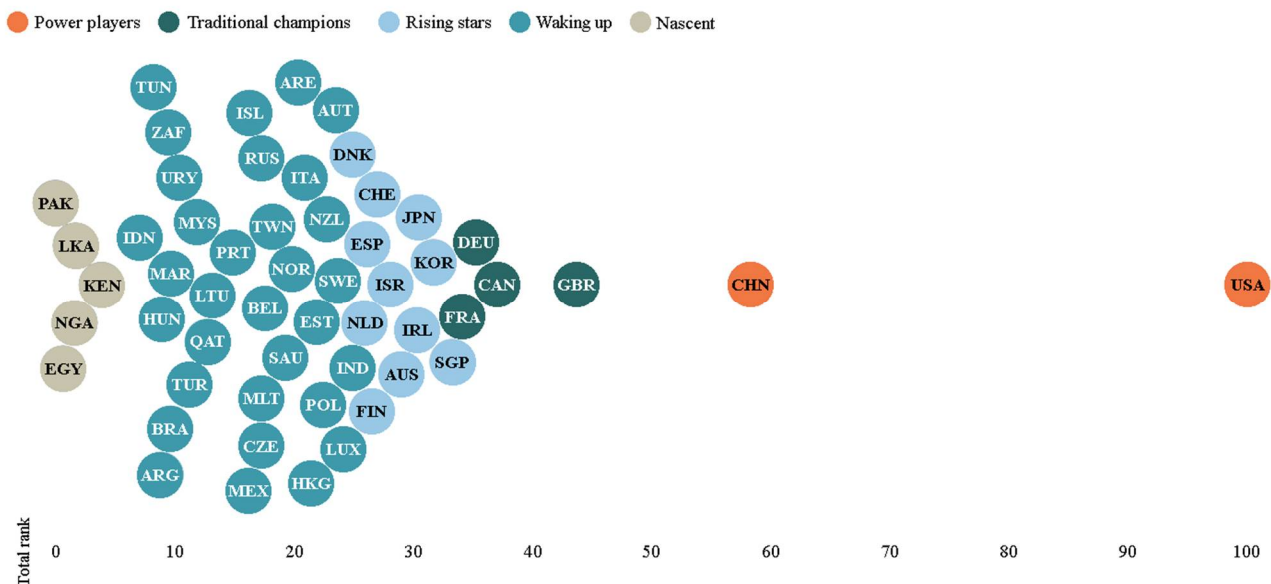

Figure 3. The Global AI Index by Tortoise Media.

Position of Countries according to Their Total Rank

Source: [32]

2019 survey by the MIT Sloan Management Review and Boston Consulting Group of more than 3000 business executives found that pioneering companies prioritize revenue-generated AI applications over cost-saving ones. They are scaling AI throughout their company operations and are involving high-level management in AI initiatives [22]. AI turns out to be a gamechanger for business generally and digital media industry in particular. According to World Economic Forum, digital media is defined as “products and services that come from the media, entertainment and information industry and its subsectors. It includes digital platforms (e.g. websites and applications), digitized content (e.g. text, audio, video and images) and services (e.g. information, entertainment and communication) that can be accessed and consumed through different digital devices” [37].

AI continue to transform the digital media business, impacting everything from content creation to consumer experience. As Rainer Kellerhals, Microsoft’s Media and Entertainment industry lead for the EMEA region, explained in 2018: “AI will influence all parts of the media value chain, helping content creators to be more creative, helping content editors to be more productive, and helping content consumers to find the content that matches their interests and current situation” [13].

2. AI Implementation in Business Activities of Digital Media Companies

Some companies, e.g. Netflix, Spotify, Amazon, Google, Facebook, Microsoft etc., are aggressively adopting efficient practices of accumulation of unique data, deployment of sophisticated analytics and enhanced usage of AI, while other companies are not. There can be numerous obstacles (time, money, company culture etc.), which restrict companies’ ability to adopt AI, however, the fact is that such companies are losing battle to AI-powered companies. Since AI implementation turns out to be a table stake for survival of digital media companies, it’s worth considering successful examples of such implementation during different stages of digital media production (Figure 4).

During stages of development and pre-production of digital media, AI can help curate the idea creation of future content. A well-known example for the AI-based curated content is popular Netflix series “House of Cards”. Based on its users’ previous consumption of content included in the Netflix library, the company discovered that users who watched the original BBC series “House of Cards” also liked movies directed by David Fincher and movies starring Kevin Spacey [4].

Different Stages of Digital Media Production

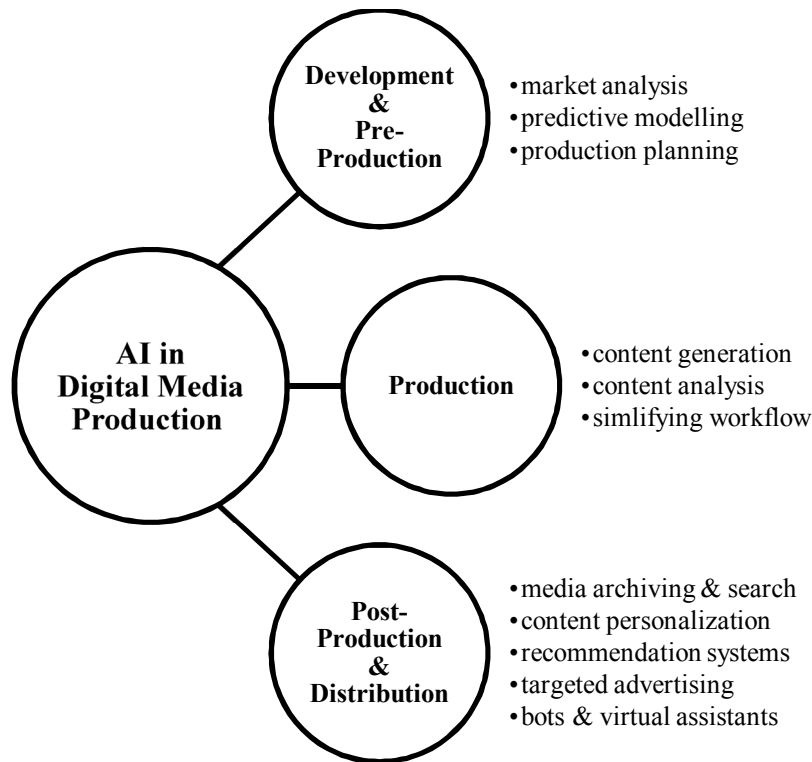

Figure 4. Implementation of AI Technologies during

Source: made by authors

House of Cards was the first Netflix show, which the streaming service used as a sort of testing ground for big data and AI analytics, investing over \$100 million into the show without even seeing a pilot. The first season had an instant success all over the world: House of Cards, directed by David Fincher and starring Kevin Spacey, became the first internet-based series to be nominated and win Emmy and Golden Globe awards [17].

Each next season of the show had more viewers and awards than the previous one, until the departure of Kevin Spacey, who was fired by Netflix following sexual assault allegations in 2017. This fact only strengthened the validity of AI correlation of series, director and star actor. Lacking Kevin Spacey, season 6 premiere episode of “House of Cards” had an average minute audience of 2.9 million viewers during its first seven days of availability (2-8 November 2018) compared to 4.4 million for the Season 5 premiere episode [39].

Netflix uses a really efficient model of knowledge production. Each day more than 167 million subscribers around the world [18] on their own initiative fuel the company with new data, e.g. what films, series or shows they watch, what time of day they watch them and on what devices, what time they pause, rewind and fast forward, what content they rate, search for etc. [12, p. 247]. In such a way Netflix practices what Antoinette Rouvroy calls “data behaviourism”, defined as “producing knowledge about future preferences, attitudes, behaviours or events without considering

the subject's psychological motivations, speeches or narratives, [instead] relying on data. The "real time operability" of devices functioning on such algorithmic logic spares human actors the burden and responsibility to transcribe, interpret and evaluate the events of the world. It spares them the meaning-making processes of transcription or representation, institutionalization, convention and symbolization" [16, p. 55].

However, Netflix is far not the only company engaged in data behaviourism. It is widely implemented by leading companies across all media industry, including video-on-demand, digital music, video games, e-publishing or social media. For instance, digital media services such as video (e.g. ESPN, HBO Now, Amazon Prime Video, Hulu and iQiyi) and music streaming platforms (e.g. Spotify, Napster, Deezer, Pandora and Amazon Music) commonly use recommendation systems to predict a user's preference based on what they have previously consumed. The system then provides a list of recommendations with content potentially interesting to the user. AI may help to learn and understand the user's behaviour even better. Instead of making suggestions based on what the user has seen, AI can make recommendations based on what the user has liked about their favourite shows, movies, books or music. In the case of music this can include parameters like the danceability or the energy level of a track.

One example is Spotify's playlist "Discover Weekly", which was introduced in 2015 and reached 40 million people and streamed 5 billion tracks during its first year [5]. Discover Weekly analyses the user's search history pattern and potential music preference, combines it with hot and new content on Spotify and updates each Monday with 50 new songs, which a user is likely to enjoy. This AI-powered feature increases the user retention and enables greater exposure for artists, who may not be searched for organically. To generate the "Discover Weekly" personalized music list, Spotify uses a combination of three models: collaborative filtering, natural language processing (NLP) and convolutional neural networks (CNN).

Collaborative filtering involves comparing a user's behavioural trends with those of other users. Spotify analyses users' interactions, such as the number of times a user has played a particular song, saved a song to their lists or clicked on the artist's page upon listening to the song, to provide relevant recommendations for other users that have been deemed similar [28].

NLP analyses human speech via text. Spotify's AI scans tracks' metadata, as well as blog posts and discussions about specific musicians and news articles about songs or artists on the internet to identify descriptive keywords. These keywords are then categorized into "top terms" and "cultural vectors" [36]. Every artist and song are associated with thousands of top terms that are adjusted on a regular basis. Each term is assigned with a weight, representing its relative value in terms of how many times a user would attribute that term to a song or a musician they like (Table 2).

CNN increases accuracy, because obscure and new songs might be neglected by other models. Each song is converted into a raw audio format called waveform. These waveforms are processed by CNN and then each song is assigned with key parameters such as beats per minute, loudness, major/minor key and so on. Spotify then builds its recommendation lists considering key parameters of the songs their users are listening to and are likely to listen to [31].

**Table 2. Example of Cultural Vectors and Top Terms with
Respective Assigned Weight**

n2 Term	Score	np Term	Score	adj Term	Score
dancing queen	0.0707	dancing queen	0.0875	perky	0.8157
mamma mia	0.0622	mamma mia	0.0553	nonvilonet	0.7178
disco era	0.0346	benny	0.0399	swedish	0.2991
winner takes	0.0307	chess	0.0390	international	0.2010
chance on	0.0297	its chorus	0.0389	inner	0.1776
swedish pop	0.0296	vous	0.0382	consistent	0.1508
my my	0.0290	the invitations	0.0377	bitter	0.0871
s enduring	0.0287	voulez	0.0377	classified	0.0735
and gimme	0.0280	something's	0.0374	junior	0.0664
enduring appeal	0.0280	priscilla	0.0369	produced	0.0616

Moreover, AI is already a part of the professional production of today's music. Compared to the beginning of this development in the 1990s, when software was able to randomly rearrange parts of different lyrics, music-making programs nowadays influence the music production on a deeper level. Apps like Apple's Logic already use AI to automatically detect and mark the tempo of sound tracks. Apart from Apple a bunch of other big companies like IBM and Google have discovered the potential of AI in the field of music creation. The base of AI-supported music software are deep learning networks that analyse large amounts of music data in order to find patterns within chords, tempo, length or notes and to eventually write melodies.

Such software often lacks a simple usability. An exception from this is Amper Music, an easy-to-use website, which does not request any coding skills nor experience in music composition. Users simply have to set preferences based on pre-recorded samples, change tempo and key and choose which instruments they want to have present in the audio. From here it is no big step to producing songs or whole albums for the masses. Moreover, the simplicity of software like Amper also enables amateurs to let their creativity and visions run free.

One of companies, which present progress in AI-supported music creation, is called Popgun. Since 2016, the Australian start-up Popgun has been exploring to what extent AI is able to create professional music. The core of Popgun's business model is its AI called Alice. After it had demonstrated Alice's skills in 2017, when she was able to continue previously heard human piano playing, Popgun raised seed funding in February 2018. Given the technical progress Popgun has already made with its AI "Alice" and the support of the big Silicon-Valley-based tech accelerator Khosla Ventures and former Pandora CEO Tim Westergren, Popgun has a considerable lead in the race of AI-based music production. Alice's creators see it as a tool that could help producers to easily generate songs by playing all kinds of instruments together. The core of its business model is not only to provide users with AI-based remixes of already existing songs or to help with post-production (e.g. like LANDR), but to create totally new songs from scratch. Only vocals remain man-made. Popgun's declared aim is to help produce — not less than — tomorrow's next pop hits. Nevertheless, Alice is still struggling with certain kinds of music and beats — a circumstance that Alice will keep trying to solve by machine-learning [7].

The bright example of AI usage in media production is the modern way of creating news materials by big media companies.

AI systems are used to enhance the still human-powered journalistic news processes and organizational workflows. Using advanced algorithms of AI against vast amounts of press release data, social media posts, blog posts, comments, images, videos and all sorts of unstructured content, media organizations can accelerate the creation of fast-breaking news and generate content that accurately summarizes changing situations. In addition to information aggregation, some content organizations are implementing AI systems that generate entire articles from scratch.

For instance, approximately one third of Bloomberg News content is published with the help of automated intelligence. The AI system used by the company, called Cyborg, is able to assist reporters in publishing thousands of articles on companies' financial reports every quarter. The software can detect and analyse a financial report as soon as it appears on a company's website and instantly publish the news, which will include the most relevant facts and figures [20].

The Associated Press has used AI technologies since 2014. Its AI does an excellent job of producing 4400 quarterly earnings stories, which is an almost 15-fold increase over its manual efforts. What's more, the Associated Press automated the announcement of sport match results and identification of the best players. The automation of data-driven stories has freed up about 20 percent of the time, which journalists could dedicate to writing critical and qualitative articles [2].

The Washington Post has the AI reporting software called Heliograf. It was first used during the 2016 Summer Olympics to provide information such as the results of medal events for services like Alexa. What's more, during the 2016 United States presidential election it created approximately 850 articles and earned The Washington Post an international award for its "Excellence in Use of Bots" [14].

Forbes built from scratch its own publishing platform called Bertie, which was named after founder Bertie Charles Forbes and introduced in July 2018. During the idea phase, Bertie can offer suggestions for stories or trending topics relevant to a writer's previous articles and their audience. During the creation phase, the system can create rough drafts on a given topic with links to relevant materials. During the distribution phase, the system helps get content to the right places by optimizing headlines, images, length of article and time of publication [8].

During media distribution phase, AI can optimize advertising and marketing by finding users' patterns that can suggest better ways to connect with readers and provide better results for advertisers and content monetization. Digital advertising across search, content and social media channels, gives an almost unlimited ability to generate data on what works and what doesn't. With the right data (e.g. audience features, type of ad delivery, placements, design of ad asset etc.), AI-powered ad tools (e.g. Facebook Business Manager or Google Marketing Platform) can detect patterns at scale in the existing data and predict what changes to campaigns will improve performance against specific KPIs. AI for advertising has the ability to increase the company's return on ad spend and reduce the amount of money the company spends on staff time and ineffective ad budget.

AI can significantly maximize engagement levels learning from the readers' behaviour and serving them with the right content. For example, in 2019 Twiipe published results of its project "JAMES, Your Digital Butler", which is a CRM decisioning AI driven by machine learning. The project was developed collaboratively by The Times & The Sunday Times and Twiipe with partial financial support of the Google Digital News Initiative. The goal of project JAMES, which stands for "Journey Automated Messaging for higher Engagement through Self-Learning", is to grow the subscribers base by individualizing the way the content of editions is distributed. During a 1-year

project, JAMES served over 100,000 subscribers of The Times with individualized newsletters compiled from the content of a daily edition. Throughout the project time frame, six different propositions were tested, combining the following models:

1. time: the best time to send an email;
2. content: which content triggers reading;
3. format: layout and copy;
4. frequency: the number of emails sent.

The Daily Briefing Proposition was one of such propositions. For example, for the Daily Briefing Proposition, they selected a representative sample of 60,000 subscribers who were not receiving any other newsletters. Each day, during a period of 10 months, they received a JAMES newsletter (Figure 5).

JAMES Daily Briefing Proposition

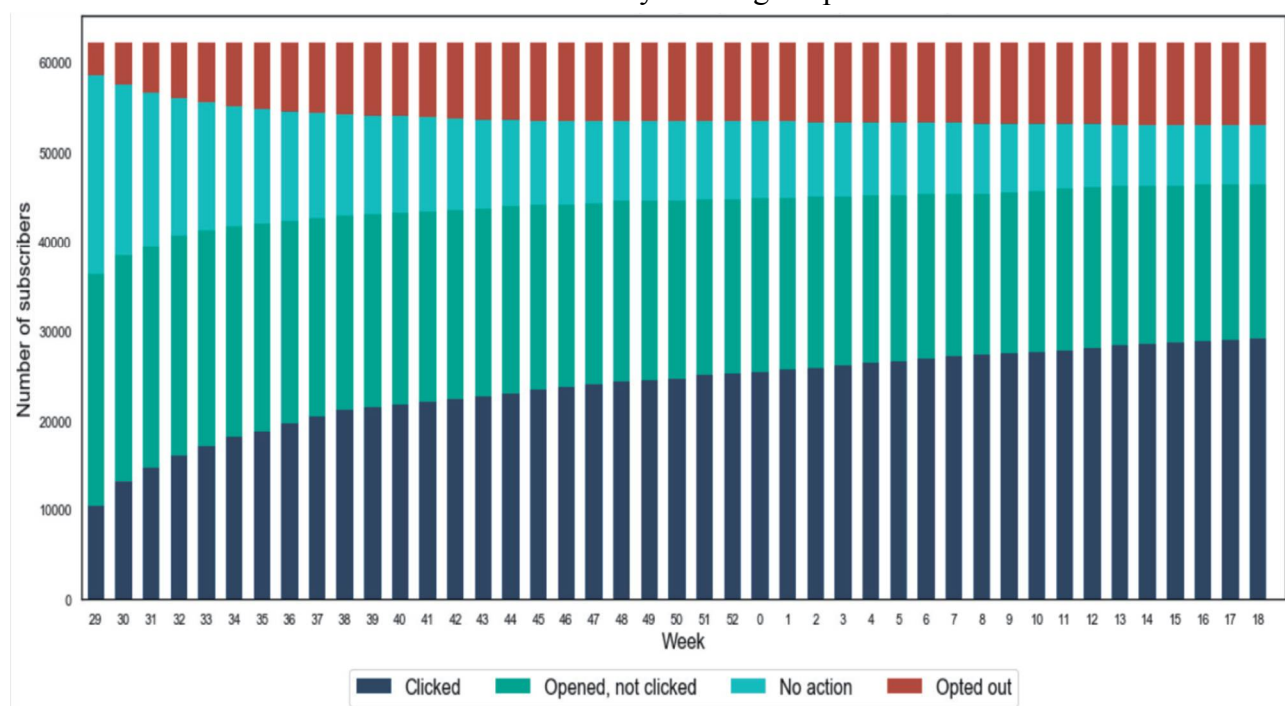

Figure 5. Evolution of Original 60,000 Subscribers Receiving

Source:[33]

As a result of JAMES, The Times was able to meet the goals of more individualized distribution, change internal culture and create business impact with customer engagement and retention. AI showed that it can effectively distribute content, since 70% of subscribers in the test interacted with JAMES. When comparing standard content recommendation to JAMES technology, the churn was reduced much more with JAMES — 49% decrease with the latter versus 14% decrease with the former. What's more, they saw the biggest impact for low/medium subscribers, a group that's normally seen as the most difficult to retain engagement, whilst 15% of highly engaged subscribers opted-out. This demonstrated that loyal readers already have secure habits and desire less contact [33].

Improving personalization of news distribution is a crucial issue for competitiveness of digital media product, so leading media companies explore the potential of new AI technologies to deliver news and information. For example, Reuters has recently shown that it can enhance the scale and personalization of news in ways previously unimaginable. In February 2020, it announced

its prototype: a fully automated, yet presenter-led sports news summary system. Developed in collaboration with London-based AI startup Synthesia, the system creates a fully-programmable virtual presenter by combining video footage of a human presenter with AI technology. The host, who looks and sounds exactly like the presenter reading a sports recap, then delivers match summaries using Reuters photography and reports to provide key action and commentary without any human scripting, editing or production [24].

AI technologies provide useful tools to help content producers and publishers to check the accuracy of information, identify fake news and reduce their impact on their readership. AI systems are capable of identifying patterns of real data sources and real news content from those that have been artificially created. These machine learning systems can serve as a first-pass editorial control, which can verify news items against additional sources, automatically provide verification from third-party sources and further help reinforce real news stories or debunk fakes. Not only the original stories can be potentially fake, but also the comments and user generated content. Machine learning systems can serve as assistants that can check the text of posted content, the content of images to make sure that only appropriate and acceptable images are posted and other user posts meet acceptable guidelines.

For example, in 2020 social media giants are aggressively fighting fake news about Covid-19 using their AI technologies. Twitter deletes any tweets, which give misinformation about coronavirus, including unverified claims that incite people to action [34]. Facebook works with over 60 fact-checking organizations that review and rate content in more than 50 languages around the world. They started showing messages in News Feed to users who have liked, reacted or commented on harmful misinformation about COVID-19 that Facebook later removed, encouraging users to visit the World Health Organization's site [25]. WhatsApp has announced that any message, which has been forwarded five or more times, will now face a new limit that will prevent a user from forwarding it to more than one chat (contact) at a time [35]. What's more, WhatsApp also launched a new chatbot, created in conjunction with the World Health Organization, which provides access to accurate and timely information on the coronavirus pandemic to the app's 2 billion users [38].

Bots represent another major segment of AI implementation, since a computer program that simulates human activity can be very useful for an individualized approach to every user without involvement of human resources. For example, in video games, such as Fortnite, a bot is a type of AI-based expert system software that plays a video game in the place of a human. AI bots behave similarly to normal players and help provide a better path for players to grow in skill. Bots work in conjunction with the game's matchmaking system and as the user's skill improves, they face fewer bots [11]. In case of different e-publishers, such as The Washington Post, bots serve as "conversational agents" or "chatbots", with the help of which users can get personalized content/event/task recommendations, access content they need swiftly and seamlessly and get notifications for exclusive content or event updates [3].

Conclusions

In terms of knowledge economy, AI is becoming an integral part of modern media companies. Technological progress in the fields of big data, algorithmic development, connectivity, cloud computing and processing power have made the performance, accessibility and costs of AI more favourable than ever before.

AI can be defined as human intelligence exhibited by machines; systems that approximate, mimic, replicate, automate and eventually improve on human thinking. Depending on the human involvement in the work of AI, there are four types of AI:

1. Assisted intelligence, which improves the performance of existing activity.
2. Augmented intelligence, which gives new capability to human activity, permitting do things a human couldn't do before.
3. Automated intelligence, which automates the performance of tasks.
4. Autonomous intelligence, which involves automating decision making processes without human intervention.

Such companies, as Netflix, Spotify, Facebook, AT&T, Walt Disney etc., are increasingly leveraging AI to change the way content is generated, produced, published and shared. AI can increase the efficiency of all stages of digital media production. During stages of development and pre-production, AI is used for market analysis, production planning, predictive modelling and curation of the idea creation. A well-known example for an AI-based curated content is popular Netflix series "House of Cards". AI systems are used to enhance the still human-powered content generation processes and organizational workflows. For example, news organizations develop AI systems that generate entire articles from scratch. As for post-production and distribution stages media implement AI for media archiving, content personalization and targeted advertising. For instance, digital media services commonly use recommendation systems to predict a user's preference based on what they have previously consumed. In such a way, data-driven organizations led to the emergence of "data behaviourism", which means producing knowledge about future preferences, attitudes, behaviours or events without considering the subject's psychological motivations, speeches or narratives, instead relying on data.

All in all, AI allows companies to take an individualized approach to working with customers, develop products and services based on their needs and identify growth opportunities as quickly and accurately as never before.

References

1. Alpaydm, E. (2010). *Introduction to Machine Learning*. 2nd ed. Cambridge: The MIT Press.
2. Automated Insights. (2020). *The Associated Press*. Retrieved April 27, 2020 from <https://automatedinsights.com/customer-stories/associated-press/>
3. BotCore. (2020). *Chatbots for Media and Entertainment*. Retrieved April 27, 2020 from <https://botcore.ai/media-and-entertainment-bots/>
4. Carr, D. (2013). *Giving Viewers What They Want*. Retrieved April 27, 2020 from <https://www.nytimes.com/2013/02/25/business/media/for-house-of-cards-using-big-data-to-guarantee-its-popularity.html>
5. Constine, J. (2015). *Spotify's Latest Trick is a Personalized News Feed-Style "Discover Weekly" Playlist*. Retrieved April 27, 2020 from <https://techcrunch.com/2015/07/20/why-browse-when-you-can-play/>
6. Davenport, T. H. (2018). *The AI Advantage: How to Put the Artificial Intelligence Revolution to Work*. Cambridge: The MIT Press.

7. Dredge, S. (2017). *AI and Music: Will We Be Slaves to the Algorithm?* Retrieved April 27, 2020 from <https://www.theguardian.com/technology/2017/aug/06/artificial-intelligence-and-will-we-be-slaves-to-the-algorithm>
8. Eide, N. (2019). *All about "Bertie": Overhauling CMS Technology at Forbes*. Retrieved April 27, 2020 from <https://www.ciodive.com/news/all-about-bertie-overhauling-cms-technology-at-forbes/554871/>
9. Evans, B. (2018). *The #1 CEO of the Year in the Cloud Wars: Microsoft's Satya Nadella*. Retrieved April 27, 2020 from <https://www.forbes.com/sites/bobevans1/2018/01/10/the-tech-industry-ceo-of-the-year-microsofts-satya-nadella/#1c41a4d26c62>
10. Finlay, S. (2018). *Artificial Intelligence and Machine Learning for Business: A No-Nonsense Guide to Data Driven Technologies*. 3rd ed. London: Relativistic.
11. Fortnite. (2019). *Fortnite Matchmaking Update — Battle Royale*. Retrieved April 27, 2020 from <https://www.epicgames.com/fortnite/en-US/news/fortnite-matchmaking-update-battle-royale>
12. Giblin, M. J. (2017). *Leadership and Management in Police Organizations*. Los Angeles: SAGE Publications.
13. James, L. (2018). *How Artificial Intelligence is Transforming the Media Industry*. Retrieved April 27, 2020 from <https://www.technologyrecord.com/Article/how-artificial-intelligence-is-transforming-the-media-industry-72457>
14. Martin, N. (2019). *Did a Robot Write This? How AI is Impacting Journalism*. Retrieved April 27, 2020 from <https://www.forbes.com/sites/nicolemartin1/2019/02/08/did-a-robot-write-this-how-ai-is-impacting-journalism/#6b660ffc7795>
15. McCarthy, J. (2007). *What is Artificial Intelligence?* Retrieved April 27, 2020 from <http://jmc.stanford.edu/artificial-intelligence/what-is-ai/index.html>
16. McDonald, K., Smith-Rowsey, D. (2016). *The Netflix Effect: Technology and Entertainment in the 21st Century*. New York: Bloomsbury Publishing.
17. Nasdaq. (2016). *The Importance of "House of Cards" to Netflix*. Retrieved April 27, 2020 from <https://www.nasdaq.com/articles/importance-house-cards-netflix-2016-03-04>
18. Netflix Investors. (2019). *2019 Quarterly Earnings*. Retrieved April 27, 2020 from <https://www.netflixinvestor.com/financials/quarterly-earnings/default.aspx>
19. Partnership on AI. (2020). *Partners*. Retrieved April 27, 2020 from <https://www.partnershiponai.org/partners/>
20. Peiser, J. (2019). *The Rise of the Robot Reporter*. Retrieved April 27, 2020 from <https://www.nytimes.com/2019/02/05/business/media/artificial-intelligence-journalism-robots.html>
21. PwC. (2018). *Sizing the Prize: What's the Real Value of AI for Your Business and How Can You Capitalise?* Retrieved April 27, 2020 from <https://www.pwc.com/gx/en/newsroom/docs/report-pwc-ai-analysis-sizing-the-prize.pdf>
22. Ransbotham, S., Khodabandeh, S., Fehling, R., LaFountain, B., Kiron, D. (2019). *Winning with AI*. MIT Sloan Management Review and Boston Consulting Group. Retrieved April 27, 2020 from https://image-src.bcg.com/Images/Final-Final-Report-Winning-With-AI-R_tcm9-231660.pdf

23. Rao, A. (2017). *A Strategist's Guide to Artificial Intelligence*. Retrieved April 27, 2020 from <https://www.strategy-business.com/article/A-Strategists-Guide-to-Artificial-Intelligence?gko=d2e2b>
24. Reuters. (2020). *Reuters and Synthesia Unveil AI Prototype for Automated Video Reports*. Retrieved April 27, 2020 from <https://www.reuters.com/article/rpb-synthesia-prototype/reuters-and-synthesia-unveil-ai-prototype-for-automated-video-reports-idUSKBN201103>
25. Rosen, G. (2020). *An Update on Our Work to Keep People Informed and Limit Misinformation about COVID-19*. Retrieved April 27, 2020 from <https://about.fb.com/news/2020/04/covid-19-misinfo-update/>
26. Russell, S., Norvig, P. (2020). *Artificial Intelligence: A Modern Approach*. 4th ed. Hoboken: Pearson Education.
27. Schwab, K. (2016). *The Fourth Industrial Revolution*. Geneva: World Economic Forum.
28. Sen, I. (2019). *How AI helps Spotify Win in the Music Streaming World*. Retrieved April 27, 2020 from <https://outsideinsight.com/insights/how-ai-helps-spotify-win-in-the-music-streaming-world/>
29. Stanford Institute for Human-Centered Artificial Intelligence. (2019). *Artificial Intelligence Index Report 2019*. Retrieved April 27, 2020 from https://hai.stanford.edu/sites/g/files/sbiybj10986/f/ai_index_2019_report.pdf
30. Statista. (2019). *Top 200 Companies: Media & Entertainment*. Retrieved April 27, 2020 from <https://www.statista.com/study/41319/top-100-media-companies/>
31. Tambekar, A. (2019). *3 Machine Learning Models Spotify Uses to Recommend Music You'll Like*. Retrieved April 27, 2020 from <https://www.mygreatlearning.com/blog/3-machine-learning-models-spotify-uses-to-recommend-music-youll-like/>
32. Tortoise Media(2019). *The Global AI Index*. Retrieved April 27, 2020 from <https://www.tortoisemedia.com/intelligence/ai/>
33. Twipe. (2019). *JAMES, Your Digital Butler*. Retrieved April 27, 2020 from <https://gallery.mailchimp.com>
34. Twitter. (2020). *Coronavirus: Staying Safe and Informed on Twitter*. Retrieved April 27, 2020 from https://blog.twitter.com/en_us/topics/company/2020/covid-19.html
35. WhatsApp Blog. (2020). *Keeping WhatsApp Personal and Private*. Retrieved April 27, 2020 from <https://blog.whatsapp.com/>
36. Whitman, B. (2012). *How Music Recommendation Works — and Doesn't Work*. Retrieved April 27, 2020 from <https://notes.variogr.am/2012/12/11/how-music-recommendation-works-and-doesnt-work/>
37. World Economic Forum. (2016). *Digital Media and Society Report*. Retrieved April 27, 2020 from http://www3.weforum.org/docs/WEFUSA_DigitalMediaAndSociety_Report2016.pdf
38. World Health Organization. (2020). *WHO Health Alert Brings COVID-19 Facts to Billions via WhatsApp*. Retrieved April 27, 2020 from <https://www.who.int/news-room/feature-stories/detail/who-health-alert-brings-covid-19-facts-to-billions-via-whatsapp>
39. Zara, C. (2018). *People Who Stuck with Netflix's "House of Cards" until the Very End Were Different in Two Ways*. Retrieved April 27, 2020 from <https://www.fastcompany.com/>

Lilia Bodenchuk

PhD in Economics

The Danube branch

PJSC «Higher educational institution

«Interregional Academy HR»

COMPANY HUMAN RESOURCE MANAGEMENT IN CONTEXT OF GENERATIONAL THEORY

***Abstract.** Main principles of generational theory of Neylom Howe and William Strauss and its relationship with staff motivation are considered. Based on generational theory, incentives are proposed that should mainly have positive effect on employees' motivation. Existing methods of staff evaluation are considered and the most relevant methods for evaluating public servants' work are determined, considering generational theory. Peculiarities of formation of indicators and criteria of labor evaluation for different groups of generations are considered. The peculiarities of hiring generation Y employees are determined. The article also presents measures that can be applied to staff management, adapted for different generations.*

Introduction.

Employees' motivation and stimulation is one of the important factors in economic progress development, because they are key tools for the most efficient usage of human potential. Effective system of motivation allows company not only to increase employees' work productivity, but also provides competitive benefits and stable market position.

Working with staff, it is important to consider their values, views and needs, but they will be individual for each employee. Creating system of motivation and incentives it is necessary to consider characteristics of each generation working in a company.

In the context of Fourth Industrial Revolution and highly competitive business environment, business leaders and human resources faced additional challenge: they had to form mixed teams of employees from different generations, with different values, views and needs to be considered during formulating effective motivation systems. One of the effective tools to help understand fundamental values of people of different ages is "Generational Theory".

Generational theory considers main features of generations, their values and external factors (historical and socio-economic) that influenced formation of each generation representative.

If you take this theory into account when creating a system of motivation and incentives, it will allow company to increase employees' productivity, increase profits, reduce staff turnover and attract new employees, optimize costs associated with employees' incentives.

Problem of peculiarities of study, work, behavior in society was studied by national and foreign scientists, in particular, Schwab K., Shlyaga O.V., Soldatova G., Kolosova G., Shamis E., Sapa A.V., Kats J., Popova. S.N., Miroshnikova A. However, practical significance of employees' motivation grounding from the point of view of generational theory requires deeper research.

Presenting main material

Every generation of people is unique. It has its own values, worldview, behavior. All this, of course, was influenced by socio-economic and historical factors of the time when there was generations socialization.

Despite uniqueness and differences between them, they are interconnected and interdependent. Each new generation is influenced by values and experiences of the previous one.

Differences between generations in modern world form a difficult task for HR specialists, including civil service, as it is necessary to correlate goals and objectives of company with interests of people with different values. Based on characteristics of generations in labor market, it is possible to determine their main values and correlate them for each generation on a five-point scale, where 5 points - priority values, 1 point - the least important ones. Table 1 presents assessment of different values significance for each generation.

Person's values formation is influenced by historical events of his generation.

Table 1. Assessment of values significance for different generations

No	Values	Baby boomers	X	Y	Z
1	personal growth, education	4	5	5	5
2	decent salary	5	4	4	5
3	monetary reward	5	5	4	5
4	teamwork	4	3	2	2
5	social guarantees	5	4	2	1
6	recognition of labor achievements	5	4	4	3
7	opportunity to show creativity	1	1	3	4
8	stability and reliability of profession	5	5	2	2
9	flexible schedule	3	1	5	4
10	fixed working hours	3	5	1	1
11	free informal communication at work	1	1	5	4
12	ability to work remotely	1	2	5	5

To determine strengths and weaknesses of each generation, International Staff Portal Head Hunter of Ukraine conducted online survey of attitudes towards employees of different generations in labor market, which was attended by more than 5084 counterparts. Survey results show that:

- routine work is done better by generation X,
- generation Y is the most effective with work where systematic thinking and responsibility are required,
- generation Z should be done tasks that require creative approach.

Based on assessment of values significance for each generation, it is possible to define which factors have greater impact on motivation of employees of different age groups and socio-historical context that influenced their formation (Table 2).

It should be noted that similar values for different generations are: decent salary and personal growth, education. It is important for each employee to receive enough money for their work, for them it is a kind of assessment of their work achievements. If they receive high salary, then management appreciates their contribution to company's activities and development, sees their hard work in general. Personal growth and education are also valued by generations, but this factor plays a completely different role for each of them. Generations of baby boomers and X see education as a tool to increase their relevance and competitiveness in the company. According to them, if they will constantly improve and replenish their knowledge and skills, it will provide them with high salary and allow them to stay in their jobs. Generation Y is not as attached to material values as their predecessors, which means that stability is not the most important determining factor.

Table 2. Priority values for generations

Generation	Values	Socio-historical context
Baby boomers	Decent salary. Monetary reward. Social guarantees. Recognition of labor achievements	It got its name due to increase in birth rates, which was characteristic of 1943-1963 years. Their values started their formation in postwar period, when society was quite optimistic, and teamwork was the main basis of success. Space exploration and first plastic surgery gave them feeling that a person can do absolutely anything, and guaranteed medical care formed sense of security.
X	Personal growth, education. Cash reward. Stability and reliability of profession. Fixed working hours	Generation was formed during the “Great Break”, and saw many difficulties. Representatives of this generation took on difficult task of getting themselves and their families out during formation of market economy in our country. They built their careers step by step, long and hard to achieve their goals. They are accustomed to struggle, prove, earn.
Y	Personal growth, education. Flexible schedule. Free informal communication at work. Ability to work remotely	Generation that has grown up in relative well-being, under care of hard-working parents, looks at life quite differently. They do not want to prove anything to anyone, they are not ready to earn blood and sweat. This generation grew up in an open world where all boundaries are conditional. They live for the moment. This generation trait was formed by explosive development of technologies and numerous terrorist attacks that occurred during their adulthood.
Z	Personal growth, education. Decent salary. Monetary reward. Ability to work remotely	This generation grew up in digital environment. Their social and philosophical worldview was affected by global economic crisis, development of mobile technologies, Web 2.0. This generation was born in the era of postmodernism and globalization

The most important factor in job choosing for Generation Y is gaining experience and training, and possibility of self-development is considered critical for the future. For Generation Y and Z, education is not only a way to be competitive in job market, but also primarily a lifestyle that is dictated by fashion. Nowadays, self-development and self-improvement are fashionable in all spheres of life. This makes a person interesting for others.

When analyzing generations essence, it is impossible for an employer not to consider their values. Each generation plays a special role in company’s activities due to unique qualities and views. They have their weaknesses and strengths that should be considered when hiring an employee for a particular position.

Generations of baby boomers and X mainly occupy leadership positions in various fields of work. They are experienced, stable, want recognition, reputation and high salary [1]. Representatives of this generation are ready to work hard and put the company’s interests above their own, which is certainly appreciated by management. They are confident in such employees and are ready to entrust them with the most difficult tasks and delegate their powers. Generations of baby boomers and X are ready to pass on their experience and guide less experienced colleagues.

Generation Y occupies an intermediate position. They already have some work experience, but it is not enough for a managerial position. They have great ambitions and potential for career

development. Representatives of this generation quickly learn new knowledge they need during work process. Generation Y states that a career is not their whole life [2]. They are not ready to sacrifice their personal lives because of work, they should have free time for everyday things. They are full of ideas and approaches how to implement various tasks set by management. Particular attention should be paid to motivation of this generation and generation Z, as they seek to try themselves in various fields and are not always ready to dedicate their lives to company's development and prosperity.

Table 3. Employees' value for the company

Generation	Values	Type of work
Baby boomers	They put work in the first place, companies are interesting for them above their own. They pass on their experience to young employees. Stable, well coping with their job responsibilities	Good leaders. Form teamwork. Mentoring
X	They manage people well. High efficiency, goal orientation and stress resistance	Senior and middle management
Y	Fast learning ability and high adaptability. They learn foreign languages and new technological programs well. Quickly switch from different tasks. Can combine several professions	This generation does not have enough experience to lead. They participate in various conferences and other events. Offer new ideas for company's development and improvement
Z	Talented and well-oriented in modern world with prevailing technologies. Analyze a large amount of information quickly. They offer non-standard, extraordinary solutions. Can solve several problems at once	They need experienced mentor who will coordinate their work, set tasks correctly and explain nuances

It is worth mentioning that values of employee and employer are radically different. Employer expects from employee to perform his job responsibilities well, which no doubt affects company's activities and competitiveness. On the other side of employment relationship is employee for whom his profession is a tool to meet the needs of money, self-expression, recognition, etc. And system of motivation is the link between them, encouraging employees to achieve goals set by company, and instead they receive tangible and intangible benefits [3].

To create effective system of motivation of employees of different age, it is necessary to take into account their priority values from generational theory, which will direct costs to those incentives that are needed by a particular employee.

In XXI century, the following skills are considered most relevant:

- basic level of education
- competencies;
- qualities of character.

In 2016, EU introduced updated Digital Competence framework (DigComp 2.0), which consists of 5 main blocks of competencies and in turn 21 competencies that are included in them [4].

1. Information literacy and data literacy.
2. Communication and interaction using digital technologies.
3. Ability to create digital content.
4. Security.
5. Ability to solve problems with computer technology [5, 59].

Table 4. Incentives that have great impact on generations motivation

Baby boomers	Material rewards (awards). Social guarantees (medical care, food, etc.). Social benefits. Awards, certificates for labor achievements. Trip vouchers and memberships at company's expense.
X	Material rewards with transparent system of bonuses and awards. Fixed salary. Useful gifts (focused on their needs). Courses, trainings at company's expense.
Y	Informal communication during working hours. Flexible schedule and ability to work remotely. Additional weekend. Business trips, conferences in other countries, cities. Ability to use social networks, corporate portal, various technologies during working hours.
Z	Mentoring system. Opportunity to realize own creative potential. Ability to use social networks, corporate portal, various technologies during working hours.

“Digital” literacy (or “digital” competence) occupies special place in the key competences for decent life and professional activity defined by EU.

Thus, HR specialists formulating system of motivation should take into account direct dependence of direct impact of digital literacy level on success in various activities.

An element of staff management of public servants is also staff assessment, which solves a wide range of tasks, namely:

- employees' promotion;
- improvement of staff management methods;
- staff selection and placement;
- strengthening ties between management and subordinates.

There are many methods of staff assessment, which are divided into traditional and modern. Traditional methods include: bibliographic method, given score, ranking, pairwise comparisons, standard, graphical profile and evaluation by results. Traditional methods are simple, clear and low-cost, which makes them attractive for use in budgetary institutions. But, building staff management system based on generational theory, it is more appropriate to use modern methods of staff assessment, which provide opportunities to assess employees' personal qualities, which affect results of their activity and their potential.

Modern methods include: certification, 360 °, center assessment method, human resources analysis, goal management method, assessment method of key performance indicators (table 5). Using modern methods of staff assessment of public servants allows to identify employees' personal qualities, which is fundamentally important in staff management, taking into account generational theory. For example, certification assesses employees' qualifications, knowledge and skills. It is based on employee's assessment by his manager. 360 ° method allows to identify employees' characteristics, but it is not used alone. Center assessment method reveals employees' potential and their personal qualities. Assessment is carried out by management. Human resource analysis reveals employees' commitment to company, and assessment is carried out anonymously.

Table 5. Modern methods of employees' assessment

Method	Assessment goal	Benefits	Drawbacks
Certification	Defining needs for training and staff development	Low costs	Does not consider employee's personal characteristics and evaluates him outside organizational context
360°	Development of motivation strategy and staff development	Identification of employees' strengths and weaknesses	Subjective
Center assessment method	Defining needs for training and staff development, as well as formation of staff candidates pool	High costs including working hours	Objectivity
Human resources analysis	Development of ways to motivate and increase staff loyalty, assess staff ability to achieve business goals	Reveals employees' commitment to company	Not reliable enough
Goal management method	Motivation assessment	Allows to form conscious work	Biased
Assessment method of key performance indicators	Development of motivation and monetary incentives for employees	Objective enough and positively perceived by staff	Laborious process of establishing key performance indicators

Goal management method allows to establish quality of employee's performance of key tasks, therefore, while applying this method there is obligatory condition of presence of company strategy and employees' performance goals. Assessment method of key performance indicators allows to evaluate work results.

In our opinion, goal management method is the most convenient method of public servants' performance assessment.

Staff assessment by this method is carried out in four stages (Fig. 1).

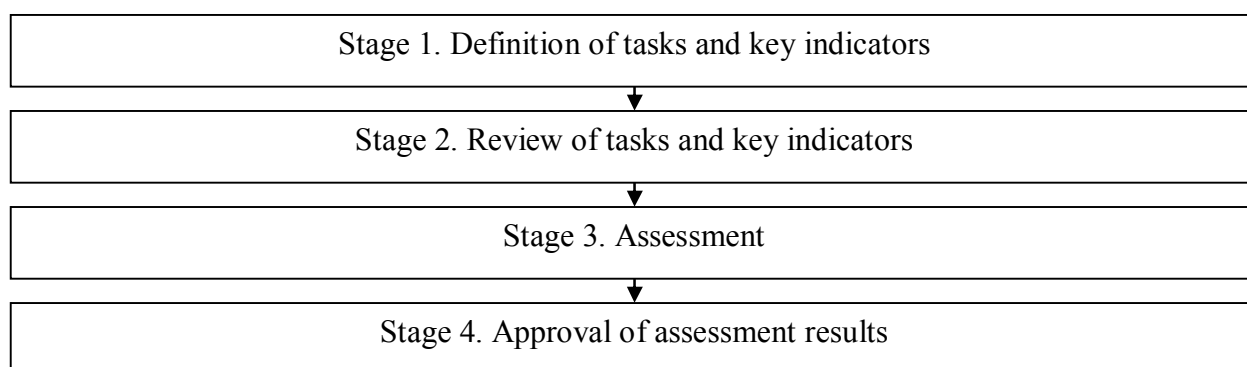
**Fig. 1. Stages of public servants' assessment**

Tasks and key indicators should reflect result on which work results will be focused. Each task must correspond to specific indicators that are grouped in a certain way and provide opportunities to assess social, economic, managerial and other performance. Specific character of public servants' work lies in provision of mainly administrative services, which determines specificity of criteria for their evaluation. Such criteria include: employee's qualification level and

his professionalism, respect for consumer, effectiveness (or positive solution of any problem), openness of information and timeliness [6]. Assessment indicators for public servants' performance include several groups (Fig. 2)

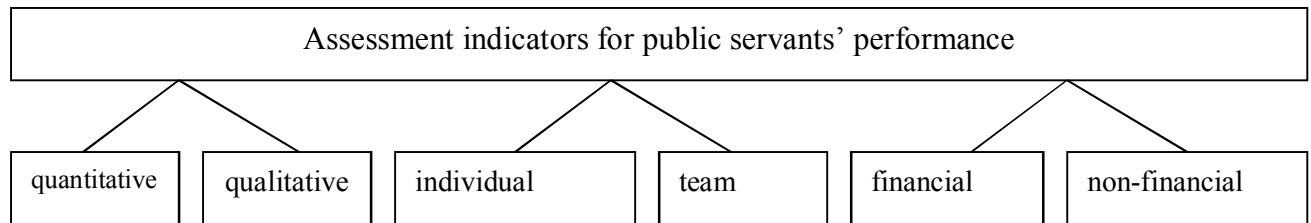

Fig.2. Groups of assessment indicators for public servants' performance

Quantitative indicators can be measured in hryvnias, units, percent. Qualitative indicators can be used to assess compliance with labor discipline, quality of paperwork, etc.

Individual indicators are used to assess personal achievement. Instead, team indicators are used to evaluate teamwork.

Financial indicators are used to evaluate financial performance, such as costs. Non-financial indicators provide opportunity to assess effectiveness of internal management processes [7].

Choosing criteria and indicators for assessing work effectiveness in budgetary institutions, it is necessary to take into account characteristics of generations. For example, for Generation Y, which aims at flexible work schedule, it is impractical to use strict adherence to labor discipline, in particular, presence at enterprise during working hours as indicators of evaluation. Generation Y performance appraisal should focus on achieving results, not on working hours.

By the way, according to experts, Generation X is able to bring more revenue to the company, and Generation Y – helps to save more. Such features must also be taken into account when defining evaluation indicators.

General approaches for formulating tasks and assessment of public servants, considering generational theory are given in Table 6.

Table 6. General approaches for formulating tasks and assessment of public servants, considering generational theory

Generation	Achievements indicators	Responsibility	Control
Baby boomers	Ability to fulfil	Responsible	Do not require strict control
X	Necessity to be forced for achieving stated goals	Do not want to take responsibility	Require constant control
Y	Depends on working conditions	Responsibility depends on awards	With proper work organization do not require increased control
Z	Require constant staff rotation	Appropriate individual responsibility	Control should be informal

Specific character of different generations also lies in setting tasks, in particular:

1. Baby Boomers recognize authorities who are able to take responsibility, so it will be appropriate for them to form tasks by management.

2. Generation X also recognizes authorities. To fulfil tasks, they require to be forced additionally. Specific character of generation X is that they are able (and interested) in solving difficult problems.

3. Generation Y sees leader as a partner, who aims to perform some tasks by his own example.

4. Generation Z does not recognize authorities; they can only be motivated.

Goal management indicators are set according to SMART principle, which means that indicators should be [8]:

-specific, i.e. concrete, to relate specifically to organization, department, employee;

-measurable, i.e. target value of quantitative and qualitative indicators is set;

-attainable, i.e. realistic, which means while determining indicator to focus on available labor, financial and material resources to achieve established indicators;

-relevant, which implies compliance with employees' qualifications and competencies, as well as being result-oriented rather than effort;

-time frame, which means setting time criteria to achieve certain indicators.

Difficulty of using this method lies in difficulty of formulating indicators. For their correct definition it is necessary that they clearly answer the questions (Fig. 3)

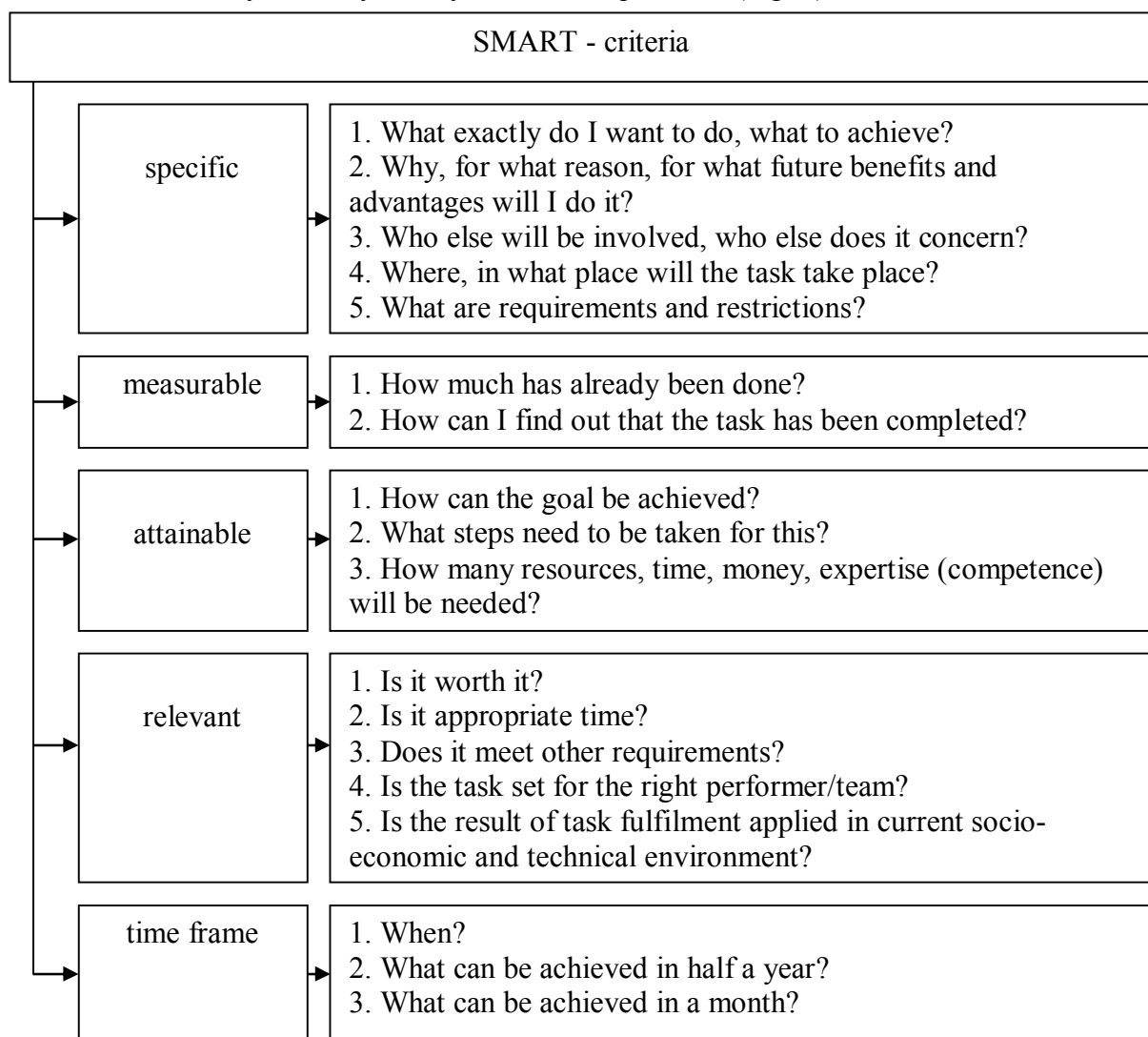

Fig.3. Formulating SMART - criteria

Thus, using goal management method provides opportunity to establish indicators, taking into account generations' characteristics, which can ensure formulating system of clear and accessible tasks of different groups of workers. It is important that number of set tasks (indicators) should be limited by (3 - 5 tasks).

Generational theory problems also apply to staffing. Key management positions today are held mainly by Generation X employees, but there is a reorientation of labor market to Generation Y employees. The following should be taken into account when developing measures to hire Generation Y employees:

- generation Y employees are characterized by lack of fear before uncertainty;
- generation Y employees often change jobs ((if, average service length at one workplace for generation X resumes is 5-6 years, then for generation Y - 1 working year);
- weakly motivated by career and long-term goals;
- require flexible work schedule;
- expect reward.

Thus, general measures that can be applied to staff management, adapted for different generations are the following:

1. Creating bonuses that can be interesting for any generation (additional weekends, membership of fitness center, etc.).
2. Ensure optimal learning process for each generation.
3. Formation of effective team taking into account interests of different generations. Before forming a new team, it is advisable to create a project team that will ensure familiarity and cohesion of employees.
4. It is advisable to create groups of representatives of different generations, which will ensure exchange of information, knowledge and experience, as well as ensuring cohesion.
5. Ensure formation of "interest groups", which will help to make closer ties with employees of older and younger generations.
6. To improve corporate company culture, which means exclusion of certain points that may affect a certain group of indicators negatively.

Conclusion.

Any organization strives to receive from its employees the highest productivity and the lowest cost. Generational theory implementation in staff management makes it possible to meet the requirements of both employees as well as employers.

So, in this article it has been determined that differences between generations in modern world set difficult task for HR specialists, as it is necessary to correlate company's goals and objectives with interests of people with different values.

It has been defined that generation X is able to cope with routine work better, generation Y is the most effective where systematic thinking and responsibility are required, and generation Z should be given tasks that require creative approach.

Each generation has its own group of values, but similar values for different generations are: decent salary and personal growth, education.

It has been determined that different groups of indicators are affected by different incentives, in particular, for Generation X – it's material rewards with transparent system of bonuses and awards, fixed salary, useful gifts (focused on their needs), courses, training for company's expense.

For Generation Y - informal communication during working hours, flexible schedule and ability to work remotely, additional weekends, business trips, conferences in other countries, cities, ability to use social networks, corporate portal, various technologies during working process.

For public servants' work assessment, it is advisable to use modern methods of staff assessment, which allow to identify employees' personal qualities. In our opinion, goal management method is the most convenient method of public servants' work assessment.

Choosing criteria and indicators for assessing work effectiveness in budgetary institutions, it is necessary to take into account characteristics of generations. For example, evaluation of Generation Y work efficiency should focus on achieving results, not on working hours.

General measures that can be used for staff management, adapted for different generations are the following: 1) creation of bonuses that can be interesting for any generation; 2) to ensure optimal learning process for representatives of each generation; 3) formation of effective team taking into account interests of different generations. 4) formation of groups from different generations; 5) creation of "interest groups"; 6) to improve corporate culture.

References

1. Shchetinina, L., Rudakovska, S., Danyliak, M. (2017). Personnel management taking into account the theory of generations. *Economics and business management*, 1, 277-283
2. Ryabykh, D. The theory of generations. *Biznes-zhurnal*. <http://www.marketing.spb.ru/lib-around/socio/generation.html>
3. Rozhavska, A (2014). Transformation of approaches to staff training. *Management issues*, 3, 6-7
4. Schwab, K. (2016). *Is the fourth industrial revolution*. Moscow: Exmo, 280
5. Shlyaga, O. (2016). Application of motivational monitoring at an industrial enterprise. *Economic Bulletin of the Zaporozhye State Engineering Academy*, 2, 38-46
6. Vinogradsky, M., Vinogradskaya, A., Shkapova, O. (2009). *Personnel Management*. textbook way. Kyiv: Center for Educational Literature.
7. Astashova, Yu. (2014). The theory of generations in marketing. *Vestnik Yuzhno-Uralskogo gosudarstvennogo universiteta*, 1, 108-113.
8. Kyrvas, V. (2014). Forming information and communication competence of modern students with the features of generation. *Aktualni pytannia navchannia*, 2, 288-292.

Irina Liganenko

Ph.D. Associate Professor

The Danube branch

PJSC «Higher educational institution

«Interregional Academy HR»

COACHING TECHNOLOGY AS MODEL FOR DEVELOPMENT OF PUBLIC SERVANTS

Abstract. *The article considers coaching model as a new form of consulting, mentoring, and training of public service managers, which allows solving the problems of an individual and organization in general. The paper analyzes relationship between coaching and management consulting, as well as motivational factors of public servants.*

Introduction

Creating conditions for public servants' lifelong learning, regardless their age and terms of civil service experience, is one of the main tasks of reforming public administration system in the country and adapting Civil Service to European Union standards.

Each employee should feel necessity to increase level of their professional competence. Improving professional level is the key to form positive public opinion about civil service.

Distinctive characteristic of professional development is its continuity, i.e. lifelong process, which provides people of different age with constant knowledge improvement and competencies expansion. Lifelong professional development of Civil Service means purposeful and planned process of positive changes in interrelated components of employee's potential in personal (first of all, motivational and axiological), educational, professional, career planning, etc., which meets the needs both of public servant and civil service system, and is carried out during the whole period of professional development.

Presenting main material

Nowadays, training is one of the main trends in the field of human resource management. Importance of employees' purposeful training has been recognized long time ago. It is commonly believed that professional training of public servants is focused on staff training to satisfy their objectives successfully. There are many methods to achieve this goal. Conveniently they can be divided into two groups:

- on-the-job training;
- off-the-job training.

On-the-job training is most often provided in form of coaching or mentoring. Coaching is managers' training during work process under constant control and assistance of a personal mentor (coach).

Mentors can be only those employees whose skills are developed at the highest level, which involves self-development and improving basic skills quality, subject of coaching is work itself and workplace. Usually managers need to develop such competencies and skills as communication, leadership, staff evaluation, conflict resolution, planning, etc.

Within the concept of professional socialization in civil service, mentoring acts as a way to share knowledge of more experienced employee with less experienced one.

In general, modern mentoring is an effective method of retaining and motivating staff, where the goal of mentoring is to create favorable conditions for effective adaptation and loyalty of staff to the organization.

Another tool of professional socialization is coaching. Coaching training in civil service promotes development of new abilities and skills. Therefore, emphasis is made on new, not past experience. Coaches focus on identifying employees' potential, provide resources that allow employees to focus on developing their abilities and skills. Prospects for using this practice in our country open up new opportunities for "growing" public servants.

Introducing coaching methods to civil service is managers' training during work process under constant control and assistance of a personal coach. Only those employees whose skills are developed at the highest level, which implies self-development and improving basic skills quality, can act as a coach.

The subject of coaching is work itself and workplace. Traditionally, managers need to develop competencies and skills such as communication, leadership, staff evaluation, conflict resolution, planning, etc.

As far as executive candidate pool concerns, we mean career coaching, which includes assessment of competence, professional opportunities, career planning counseling, selecting ways for development, skills training and support in a new position. In addition, coaching style of assessment allows diagnosing level of acquired skills, identify areas of development and build a plan for individual candidate.

Coaching (learning, training) – is a method of counseling and training [1]. Coaching differs from classic consulting and training by not giving advice and strict recommendations, but seeking solutions together with client. Coaching differs from psychological counseling by focus of motivation. Working with a coach involves achieving certain goals, new, positively formulated results in life and work. Coaching does not teach, but helps to learn.

Coaching, as technology, allows solving a number of problems:

1. Focuses on revealing potential.
2. Aimed at creating "result in process", does not provide recipes, recommendations, appointments.
3. Decision is made by a manager, a coach only helps to come to this decision.
4. Helps increase personal managers' effectiveness.
5. Aimed at forming individual management style.
6. Identifies "problem areas" in organization development.
7. Defines "growth points" (collective, personal).
8. Team building.
9. Development of organizational culture and staff motivation, etc.

Based on above mentioned, it seems that coaching should be understood as method of counseling aimed at revealing human's inner potential and putting into action system of their motivation, the main task of which is the most effective achievement of personal or professional goals.

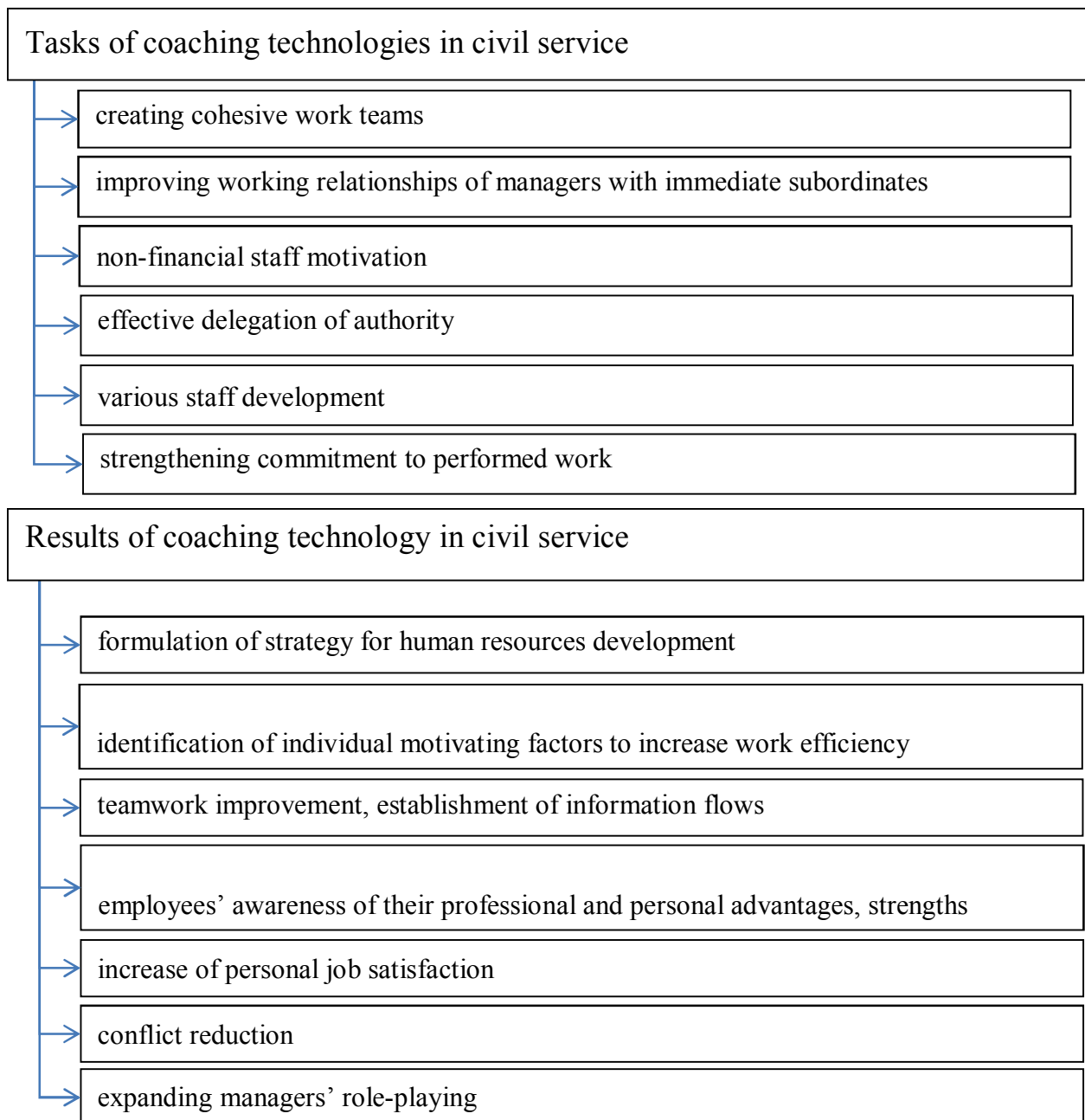

Fig.1 Peculiarities of coaching technologies in civil service

If we adapt tasks of coaching technologies to civil service, we can say that it is a process of self-development that gives employees clear idea of what they do, what they strive for and why they strive for it. No other method of human resources development takes into account personal employee's history, which allows relying on his best qualities.

Principles of equality and partnership, which are basis of coaching, give each employee the right to contribute to organizational, motivational and legal issues solution.

This technology teaches to act and think outside the box, better than required by rules of service instructions. Managers of any rank expand range of their opportunities in order to apply their professional skills, abilities and personal qualities (Fig. 1).

Coaching is revealing of human potential in order to increase its effectiveness [2].

Coaching includes four basic stages:

- goal setting,

- reality check,
- building ways of achievement,
- achieving the goal.

If we conduct comparative analysis of mentoring and coaching in civil service, we can see that as methods they are quite close, but they have a number of differences, which are shown in the table (Table 1).

Table 1. Comparative analysis of methods of mentoring and coaching in civil service.

Comparison parameter	Method	
	Mentoring	Coaching
Goal	It is based on sharing experience between experienced public servants and public servants who are beginners	Solves problems by developing public servant's independence and responsibility for result
Situation of implementation	It is mostly used during period of staff adaptation	It is not used for beginners. It aims to improve skills of experienced public servants
Duration of process	It is quite a long process because it involves learning of necessary competencies.	Duration of coaching depends on the stated goal.

To improve or control any employee's skills, it is appropriate to use method of process control. The essence of this method lies in observing employee's work by senior manager or coach (holding the meeting, stage of documentation preparation, report presentation) and further joint analysis.

For difficult situations analysis it is possible to use one of coaching models PARLA, which is an international model of behavioral analysis. This abbreviation interpretation is the following [3]:

- P-problem,
- A-action,
- R-result,
- L-learned,
- A-applied.

It may take a lot of time, questions and arguments to get results and conclusions for the future. Nevertheless, proposed model is quite simple and effective.

Usefulness of coaching as a method comparing to instructing, for public service managers and the staff, for institution that accepts coaching culture, lies in the following positions:

Coaching technologies are aimed at mobilizing internal resources of management staff, they develop necessary skills to work with dynamically changing information, contribute to development of advanced strategies for achieving results through high motivation for work, and reveal creative resources and increase responsibility for results.

1. Improving efficiency. This is the main thing for which coaching is used. Changes generated by coaching, aimed at meeting strategic goals of management staff, have cascading character, creating positive changes even outside stated area of changes.

2. Staff development. Professional development of public servants does not mean just sending them to courses once or twice a year. The process of human resources development is long-term. During their work with a coach, municipal employees get full idea about prospects of

professional and personal development, personal role in developing potential of organizational structure, they develop stable internal motivation to achieve the goal. Coaching ensures congruence of individual development of employees in order to develop potential of the team in general. Work is carried out until maximum possible result of potential is revealed.

3. Better learning. Coaching involves quick learning “without leaving the workplace”, and this process brings joy and satisfaction. Coaching technologies are aimed at mobilizing internal resources of management staff, develop necessary skills to work with dynamically changing information, contribute to development of advanced strategies for obtaining results through high motivation to work, as well as reveal creative resources and increase responsibility for results.

4. Improving relationships. When a person is asked questions, it allows you to evaluate him and his answers. Coaching adapts manager’s personality to high moral and moral qualities that must be possessed by a public servant.

5. Improving quality of life. Improving relationships and related success change work environment for better.

6. Public servant’s free time. Staff interaction in coaching style gives public servants free time to perform functions of higher importance, which they previously could not find time for, because employees take responsibility for results of their activities themselves.

Due to semi-closed nature of career system, public servants are not inclined to advertise their plans, goals and decisions. Otherwise, they risk facing opposition from competitors and blocking their ambitions. Therefore, in real practice, individual career plans, which have closed character, are cultivated,

In those government organizations where there is real rather than formal candidates pool, it makes sense to develop general career plans based on assessment of internal motivation of officials. This will form a career trajectory for each candidate, based on goals and objectives of organization. This scheme of promotion of civil service staff will make it possible to determine specific measures for motivating and stimulating public servants. The plan should include the following sections:

I. Professional development of public servant. Advanced training, retraining of managers and specialists, briefings, rotation, self-education. Along with these forms of education, you can plan special training for career self-organization (interviews, consultations, coaching sessions, etc.).

II. Stimulating career growth. It is associated with increasing prestige and attractiveness of civil service. To achieve this, meetings should be held with government administration managers, political parties and public associations; strengthening ties with the media; attracting attention of scientists, art and culture performers. Along with this, measures can be outlined to encourage employees who have career achievements.

III. Career relocations. Work with candidates’ pool: internship, project management, temporary staff, etc.; vacancy replacement planning; conducting certifications, exams, competitions, etc.

Management of public servants’ professional development as systemically organized activity in Ukraine takes place in difficult social and professional environment, which is influenced by many factors. Without any doubt, analysis of factors impact is interesting and can become an independent research task.

In our opinion, professional development takes place not only at personal (individual) level, but also on the scale of entire socio-political institution - civil service and affects entire socio-professional sphere of public administration.

This leads to necessity of identifying special group of socio-managerial factors, including reforms of civil service, state staff policy, regional features of Civil Service functioning.

Based on approaches considered in this paper, as well as principle of “external – internal” conditionality of professional development process, the most successful is classification of factors influencing professional development of public servants, which includes two clusters: extrasystemic and intrasystemic (Fig. 2).

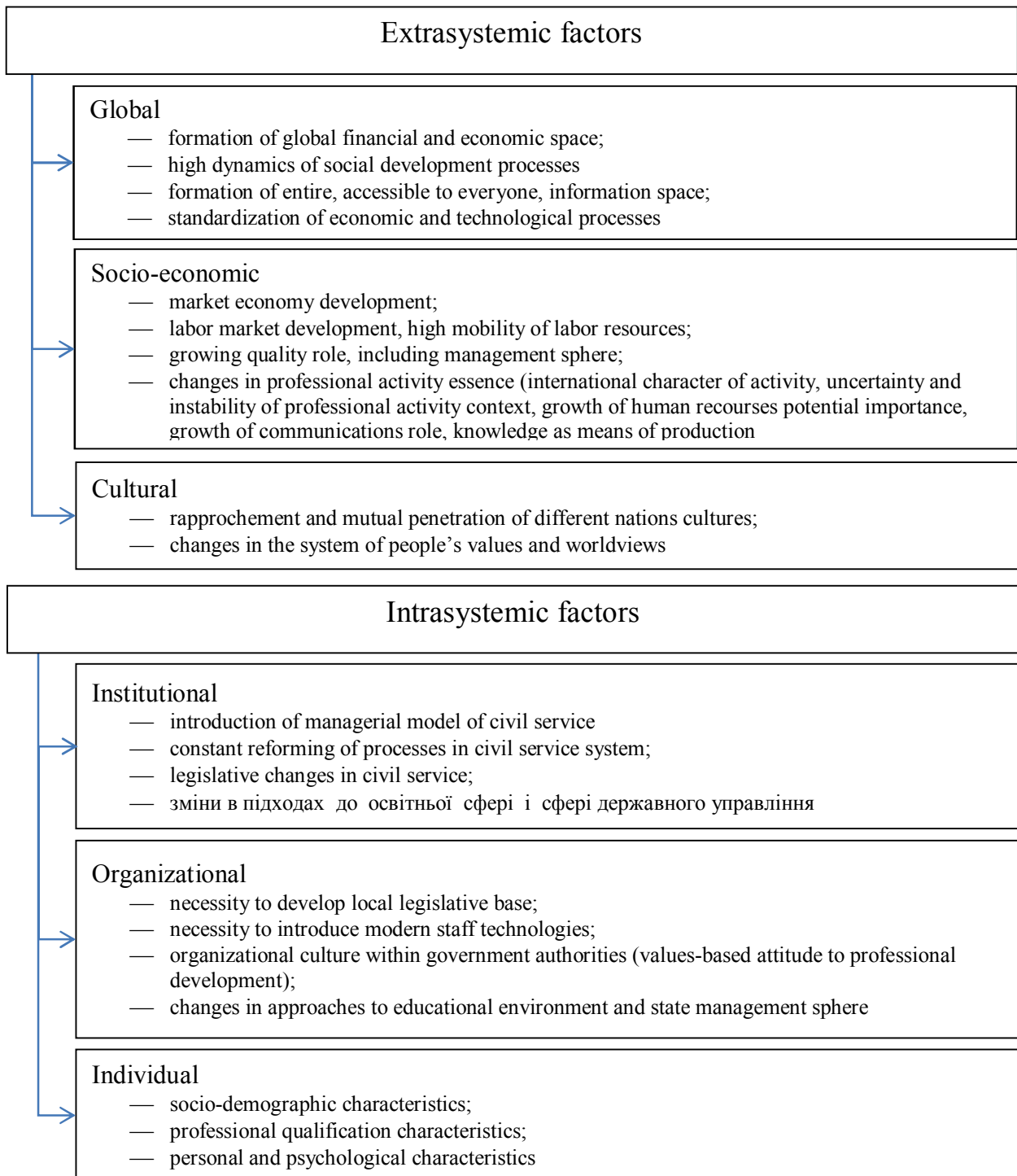

Fig. 2. Classification of factors of public servants’ professional development

Presented classification, apart from clusters determination, has internal logic and allows representing relationship and mutual influence of groups of factors “vertically” and “horizontally”. Vertically, factors are related on the principle “from public to private”.

Thus, in group of socio-economic factors, development of market economy leads to labor market appearance, labor recourses mobility and changes in professional activity essence. In group of institutional factors, implementation of managerial model of civil service leads to constant reforming of processes in civil service, which is accompanied by legislative changes and, in particular, approaches to employees’ education.

When displaying factors horizontally, principle from a larger group to a smaller scale is applied. Thus, high social processes dynamics causes dynamic changes in professional activity essence, which is accompanied by changes in the system of people’s values and worldviews, including civil service, and, accordingly, affects necessity of using new approaches to training and human resources management. Importance to consider employees’ personal and psychological characteristics. Thus, professional development process is characterized by certain patterns (integrity, continuity and staging), which are very important and should be considered when building a management system. Stages are the most important regularity of professional development. Approach considered in this study to allocation of pre-service and service stages allows to take into account peculiarities of professional development at each of them, to develop effective management system for professional development of civil servants from the moment of mastering their profession and throughout the service.

IV. Motivation and inspiration in the field of public civil service are carried out in the mode of “manual” rather than systemic management. In our opinion, coaching tools will serve as an effective tool for diagnosing and identifying priority motivators for public servants, as well as developing technologies to stimulate managers and professionals, taking into account effectiveness and efficiency of their work. Experts say that leaders of state organizations often underestimate importance of motivational factors. There is no systematic approach in their application. For this reason, there is salary imbalance, lack of transparency of state guarantees provision, there is no flexibility in assignment of positions, awards and inspiration [4].

Formulating motivational mechanism of modern officials’ service, it is necessary to consider changes of public servants’ values orientations: focus on career growth, competitiveness in work, responsibility before citizens, professionalism and innovation. Such values can be used as a basis for public servants’ inspiration.

Currently, development and implementation of modern inspiration mechanisms of public servants is becoming especially important. In the most general form, public servant’s motivation is understood as a set of driving forces that motivate a person to certain actions. Motivation is used for moral and material encouragement of public servants depending on quality and quantity of work spent. The system of material incentives includes: wages, social payments, benefits. System of moral inspiration includes employment guarantees, providing opportunities for professional development, promotion of employees, providing some independence in fulfilling some assigned functions or tasks, participation in decision-making at higher levels of management, training, letters of thanks and certificates of appreciation.

It should be noted that public servants’ motivation focuses on material incentives. Various allowances to official salary of public servants have significant impact here, in particular allowances for rank, for special conditions of civil service, as well as bonuses.

It should be noted that for Ukrainian officials, especially for category of specialists, money is certainly important. However, not all of them are aimed at monetary values. According to research, employees work for money to a certain level - personal idea about their level of “decent life”. When leaders of state organizations answered the question about motivational factors they defined “for themselves”, money was placed in third place after such factors as “success” and “professional growth”. However, money was identified as the most important motivator for “their staff”, i.e. specialists [5].

Organizational, status and symbolic factors are distinguished in the structure of social incentives. Priority is given to collective incentives. After all, final results in civil service are most often created by working groups due to coordinated interaction and cohesion of employees. At the same time, collective incentives “work” for stable groups.

Speaking about development of coaching counseling model for leaders of government authorities, it should be noted that coaching process includes elements of training, diagnostic methods, training and mechanisms of psychological assistance.

Main tasks of using coaching technologies when working with leaders of civil service are: development of leadership resources, clarification of personal goals and objectives during coaching trainings; optimization of actions and management decisions on the basis of mastering key know-how of modern development management in organization, considering rather tightly regulated structure of government service; improving skills in the field of diagnostics, formation and maintenance of corporate culture; improving persuasive communication skills; improving skills of managing employees (subordinates); mastering tools and developing skills to improve decision-making system in organization; mastering skills of self-management (time management, stress management). In accordance with considered tasks the following modules of coaching sessions can be formed:

1. Effective leadership.
2. Management of subordinates.
3. Communications management.
4. Management of institution development
5. Management of organizational culture.
6. Making management decisions.
7. Self-management.

As a result of implementation of coaching technologies can be noted:

- intensive training based on the personal practical experience of participants;
- personal development;
- increase of business efficiency;
- practice and training of professional management skills;
- ability to work out several behavioral strategies;
- development of communication skills;
- skills of forming organizational culture, teamwork;
- leadership and cooperation.

Individual coaching is carried out in the process of internship in state government authorities. Internships are introduced as additional module to training program, however, only public servants included in candidates pool of managerial staff can actually train. Other categories of candidates participate in various commissions work.

Usage of coaching techniques in civil service not only helps to increase productivity, but can also bring great success to the government, because employees, who have completed coaching, show their abilities more widely and creatively, as coaching develops independence and individual personality traits; each trained employee puts forward his ideas and is responsible for their implementation; staff adapts to changes more quickly, which contributes to development of improvement culture, service becomes more dynamic; coaching gives people energy, freedom and self-confidence, increases pace of their lives.

As far as candidates pool of managerial staff concerns, we mean career coaching, which includes assessment of competencies, professional opportunities, career planning counseling, choice of development path, skills training and support in a new position. They might be group coaching sessions, personal coaching, photo coaching (real) and remote telephone, online coaching. In addition, coaching style of assessment allows diagnosing skills level for that moment and identify areas for development and build a plan for candidate's personal development. In general, development of candidates' pool of managerial staff of public servants is built in accordance with principles of talent management, i.e. individuals which acquire abilities that allow them to obtain activity product, which differs with novelty, excellence and social significance:

- orientation on strategic interests of region - candidates' development is focused on long term perspective, considers strategic goals in the field of economic and social development of region;
- network character – candidates' development is based on creation of social network (community), which includes both candidates and other managers from organizations of real economy sector, as well as external experts who have opportunity to share ideas and management experience regardless of location;
- knowledge management - development is organized in such a way as to form intellectual capital of region: to acquire and identify valuable knowledge and experience of individual managers and their organizations, to describe and systematize them, provide knowledge exchange, create opportunities for collective experience.

Thus, this system does not have narrow profile, it is aimed at achieving various goals of organization, important from practical point of view.

We can define main prospects for coaching development in Ukraine:

- Professional associations. Transition to active development of professional coaching in Ukraine on the basis of International Union of Coaches (ICF). Due to active participation of Representation in our country, professional community will develop, annual conferences, coaching weeks and other events will be held;
- Recognition. Coaching is recognized at all levels of management. Mostly it is conducted with senior management. But at the middle level, it is also quite common. Now it is necessary to recognize coaching as a separate independent technology of staff development at scientific level, its allocation as a separate discipline;
- Scientific research. A number of scientific and practical publications have already been published in Ukraine, and research is being conducted in the field of coaching. It is assumed that in the coming years, interest in this topic will only increase and the number of studies will increase sharply;
- Distribution. Today, coaching in Ukraine is in "expansion" stage. At present, followers of American tradition are mostly represented. In our country there are very few sources and materials of coaching theory. Today, most managers in Ukrainian companies know what coaching is, understand its importance and even try to apply its basics in practice.

Coaching is a huge opportunity for Ukraine, because our country is now in a situation when we need to integrate into the world economy in the most effective way and shortest period of time. We do not have many resources that we can use for this. But our greatest resource is people, their inner potential, mood and focus on results.

Conclusion.

Coaching-consulting of government authorities' managers is a multi-stage work of coach-trainer in interaction with leader in order to provide emotional, informational and methodological support in case of problems in implementation of management activities, promote personal and professional growth of leaders by activating socio-psychological resources. Coaching with ordinary employees is necessary for personal and professional growth, development of skills relevant to their work, for managing conflict situations, mastering decision-making skills, productive communication, creating balance between work and personal life.

Thanks to coaching, public servants will learn about their abilities and become confident in their positions, will be able to make successful decisions based on benefits, including their own wellbeing.

Public servants start working better when they have a clear idea about their working tasks, have rough or clear plan for their fulfilment, and take responsibility for their activity results. However, this knowledge they receive independently, not because of instructions from above.

Thus, if this method of staff management becomes common form of interaction between employee and manager, we can assume that excellent results will be achieved: employees' self-motivation will appear, their trust to a manager will increase, which will allow them to work more effectively, revealing their potential. getting pleasure from work results and they will have desire to improve professionalism and climb the corporate ladder. As a result, staff attitude to their own work will change: from objective necessity it will become source of job satisfaction, which will contribute to self-respect growth and have a positive impact on employee's self-esteem.

References

1. Some issues of implementation of comprehensive public administration reform: Resolution of the Cabinet of Ministers of Ukraine (2017). № 647: <http://www.kmu.gov.ua>
2. Besser-Sigmund, K. (2007). Self-coaching: Culture of personal managers and leaders. St. Petersburg: Werner Regen.
3. Downey, M. (2007). Effective Coaching: Coach Coach Lessons. Moscow: Dobraya Kniga.
4. Seryogin, S., Goncharuk, S., Goncharuk, N. (2011). Personnel policy and civil service. Dnepropetrovsk: DRIDU NADU.
5. Vorona, P., Goshovska, V., Lopushinsky, P., Sharovara, T. (2016) Local authorities in the post-Soviet space. Poltava .: PP Shevchenko.

Olena Sergienko

*PhD in Economics, Associate Professor, National Technical University «Kharkiv Polytechnic Institute», Kharkiv, Ukraine
orcid.org/0000-0002-9796-9218*

Maryna Tatar

*PhD in Economics, Associate Professor, National Aerospace University «Kharkiv Aviation Institute», Kharkiv, Ukraine
orcid.org/0000-0002-1111-7103*

Oleksandr Bilotserkivskiy

*PhD in Technical, Associate Professor, National Technical University «Kharkiv Polytechnic Institute», Kharkiv, Ukraine
orcid.org/0000-0003-4707-7964*

Valeria Baranova

*PhD in Economics, Associate Professor, Karazin Kharkiv National University, Kharkiv, Ukraine
orcid.org/0000-0002-8163-881X*

APPLIED ASPECTS OF PROACTIVE MODELING OF INNOVATIVE-INVESTMENT PROCESSES OF COMPLEX HIERARCHICAL SYSTEMS: ENTERPRISE–REGION–STATE

***Abstract.** The paper proposed a proactive mechanism of innovative activity management of complex hierarchical systems (CHS), consisting of successive stages of assessment, analysis, planning, forecasting and innovative activities regulation at the levels of an enterprise - a region – the state. Specific tasks of the proposed mechanism require model support, in connection with which the author has developed a set of models for the proactive innovation management SYSTEM. The valuation models and analysis of the innovation capacity and innovation outcomes of socio-economic system of a region (SESR), which allow, in contrast to the existing models, to compare the results of innovation activities and innovation potential and to make a conclusion about the effectiveness of the existing potentia use are built. The model of evaluation of innovative projects of business-industrial structures (BIS) efficiency based on the use of fuzzy set theory and methods of multicriteria problems solution, which allow to consider the risks arising at each stage of the innovation life cycle. The set of models of economic evaluation of SESR innovative activities based on panel data, which allows to estimate the resource use efficiency in the implementation of innovative activities and to predict the consequences of managerial decisions on stimulation of innovative activities is proposed. The simulation model scenarios of stimulation of SESR innovative activity, which allowed the simulation of scenarios to stimulate and assess their performance in order to select the best scenario of innovation regional systems according to the criteria of profit maximization, maximizing the number of innovative-active BIS and maximize the gains integrated assessment of SESR innovative activity results are designed. The simulation results allowed to determine the best scenario for promoting regional systems and the state as a whole.*

Introduction.

While implementing reformation and European integration processes in Ukraine, taking into account the rapid development of the information society, the formation of innovative economy and innovative development where the role of the state is a key one, acquire special importance. The government should ensure the transition to the innovative model of development based on the use of SIFferent means of innovative processes stimulation at all levels of management. One of the most important factors that influences the acceleration of innovative processes development in the country, is a budget support of innovation at all levels.

Limited sources of innovative projects financing with own funds business-industrial structures (BIS) and with the help of domestic or foreign investors can lead to the disproportionate development of some industries compared to others, less profitable, but strategically important state industries. However, the activation of innovation activity (IA) will accelerate the development of high-priority industries, lead to an increase in the number of innovation-active BIS, the growth of profit due to the implementation of innovative activities, which in turn will affect the improvement of life quality and will meet the population needs. The issues of activation of innovation activity management at the level of regional systems are of a special importance. The socio-economic system of the region (SESR) as a territorial unit is characterized by definite managerial and financial resources and a certain innovative potential of business entities located on the territory of a regional system. The role of the state is to support management influence on innovation activities of BIS, taking into account the industrial sector they operate in to ensure the promotion of innovation development of SESR in Ukraine.

The purpose of the study is development a set of models for managing innovation activity of complex hierarchical systems (IACHS) based on existing potential, goals and results of innovation, which will accelerate the development of particular business structures, economies of regional systems and countries to improve the quality of life. To achieve this goal, the following tasks were set:

1. To analyze the development of innovation in Ukraine and the problems of its management.
2. To develop a mechanism for managing the innovation of complex hierarchical systems.
3. To build models to stimulate innovation of regional systems and business-industrial structures.
4. To improve models for assessing the innovation potential of regional systems, business-industrial structures and the results of their innovation activities.
5. To improve models for evaluating the effectiveness of innovative projects.
6. To build models for assessing the economic efficiency of innovation in regional systems.
7. To develop a model of innovative activity of business-industrial structures of regional systems.
8. To develop a simulation model of realization of innovative activity stimulation of complex hierarchical systems and to define the best scenarios of stimulation.

1. Theoretical and methodological base of research of innovative activity management problems in Ukraine

Among the researches in the scientific literature there is a significant part which deals with various aspects of functioning of innovative activity management system at the level of business-industrial structures and approaches to its modeling.

Also, most of the researches are focused on dealing with the issues of national and regional innovation management. At the level of regional innovative activity management the study is mainly related to the definition of the innovation strategy of regional systems or the development of innovation infrastructure of regions and interregional comparison of innovation performance of regional systems based on the use of integrated indicators.

The authors [1-4] focus on the "production capabilities" component and form a set of indicators of a region industrial potential estimatio. Particular attention of other researchers [5] is paid to labour and capital resources for the implementation of innovation. Therefore, the set of indicators mainly consists of those that characterize the cost of labor and capital.

The authors [6-9] propose to evaluate the following components of a region potential: scientific and technical, innovative potential, resources and results, each of which is determined by many parameters.

A special attention should be paid to the consideration of many issues relating to innovation activity and innovation policy in the current legislation of Ukraine, in particular in normative legal acts [10-17].

However, the issues of forming an effective mechanism for managing innovation at the level of regional systems and model support of such a mechanism remain out of consideration. Existing approaches to innovation management do not take into account the individual characteristics of regional innovation development and are insufficiently substantiated. Problems of innovation management of complex hierarchical systems require a comprehensive, systematic solution due to the complexity of innovation processes, individual characteristics of each regional system and business-industrial structures engaged in innovation, operating in conditions of uncertainty and the impact of many destabilizing factors, the need to take into account various conditions and criteria of management efficiency.

The complexity of the studied issues requires the use of new, modern mathematical methods and models that will assess the individual characteristics of innovative development of SESR in Ukraine and build a mechanism for managing innovation in each region, taking into account the sectoral focus of business structures, existing innovation potential, which will increase efficiency of regional systems innovation activities, increase the number of innovation-active structures, the volume of innovative products and profits from innovation.

As the research methods the following ones were used:

- theory of active systems to describe the innovation activities management system of a region socio-economic system ;
- cluster analysis to analyse regional systems according to the level of potential development and results of innovation activity;
- taxonomy method to determine the integrated indicators of potential and results of innovation activity of SESR and BIS;
- correlation-regression analysis to build models of dependence of innovation results on a potential;
- fuzzy set theory for risk assessment of an innovation project;
- method of panel data analysis for construction of econometric models of economic efficiency estimation from the realization of innovative activity of SESR;
- dynamic probabilistic model of the development of fast social and economic processes to design a model of innovative activity of BIS;
- method of system dynamics to build the simulation model of stimulation scenario of regional systems innovative activity ;
- method of simulation modeling of scenarios for the analysis of all possible ways of stimulation of regional systems innovative activity and choosing the best scenarios.

The calculations were performed using Microsoft Excel, Statistica, Eviews and Vensim.

2. The formation of a mechanism of innovation activity management in complex hierarchical systems

The statistical analysis of innovation processes in Ukraine conducted in recent years has allowed to ascertain the decline in innovation. In particular, the cost of innovation is increasing annually, but the share of business-industrial structures undertaking innovation activities decreases. This indicates the rising cost of labor, material and other resources for the implementation of innovative activities in the country, so not every company has the opportunity to implement new processes and upgrade their products. Among the reasons of this slow development of innovative processes in Ukraine it is necessary to highlight the low innovation activity of industrial enterprises, the absence of the state's stimulation of innovative activity of business entities, because the main sources of financing innovative activities of industrial enterprises (over 70%) are funds of enterprises, whereas the share of the state financing is about 2%. Also among the reasons for the slowdown of innovative development should also be mentioned the presence of disparities in regional funding of IA systems. So, the analysis indicates the necessity of improvement of state and regional innovation management mechanism, based on the use of interconnected, logically complete complex of economic and mathematical methods and models which will allow to increase the efficiency of IA management of SESR in Ukraine.

Fig. 1 shows the proposed mechanism of innovation activity management of complex hierarchical systems: an enterprise – a region – the state. The first block of the mechanism combines the problem of determining goals, objectives and implementation strategy of innovation activity of SESR. The second block is the unit of analysis of innovation activity – provides for the assessment of innovative potential of SESR and business-industrial structures, the results of their IA and assesses the compliance of results and capabilities. According to the set goals, objectives, chosen strategy, innovation potential analysis and ID results planning of IARS management is realized (block 3). Block 4 provides the assessment of the effects of IA implementation by regional authorities performing the following tasks: assessment of funded innovative projects effectiveness; assessment of economic efficiency of IARS and evaluation of the effect of BIS innovation activity. Block 5 provides a solution to the problem of making decisions on IARS management. Based on the formed set of management actions (block 3) and their forecasts (block 4) the simulation of control and possible IARS management scenarios are realized. Block 6 of the mechanism provides a solution of monitoring the results of IA implementation and regulation of IARS.

The complexity of the tasks of IARS management requires the use of a wide range of economic and mathematical methods and models. Therefore, modeling tools of support of the proposed mechanism of IARS management play a special role in ensuring the effectiveness of its operation. The complex of economic-mathematical methods and models that are interrelated, has consistently supported the implementation of blocks 2-5 of the constructed mechanism, and assess the results of various scenarios of regional systems innovative activity management, depending on the goals of the state. The problem of the mechanism of SESR innovation activity management requires an increased interaction with regional and state authorities as a single system [18, 19, 20]. Such a system of regional systems innovative activity management is considered as an active system of a certain type, within which the state authorities are considered as the top-level element, the regional authorities – as the subjects of management of the second level and business and industrial structures as the active elements that interact with each other in the process of innovations implementation [21].

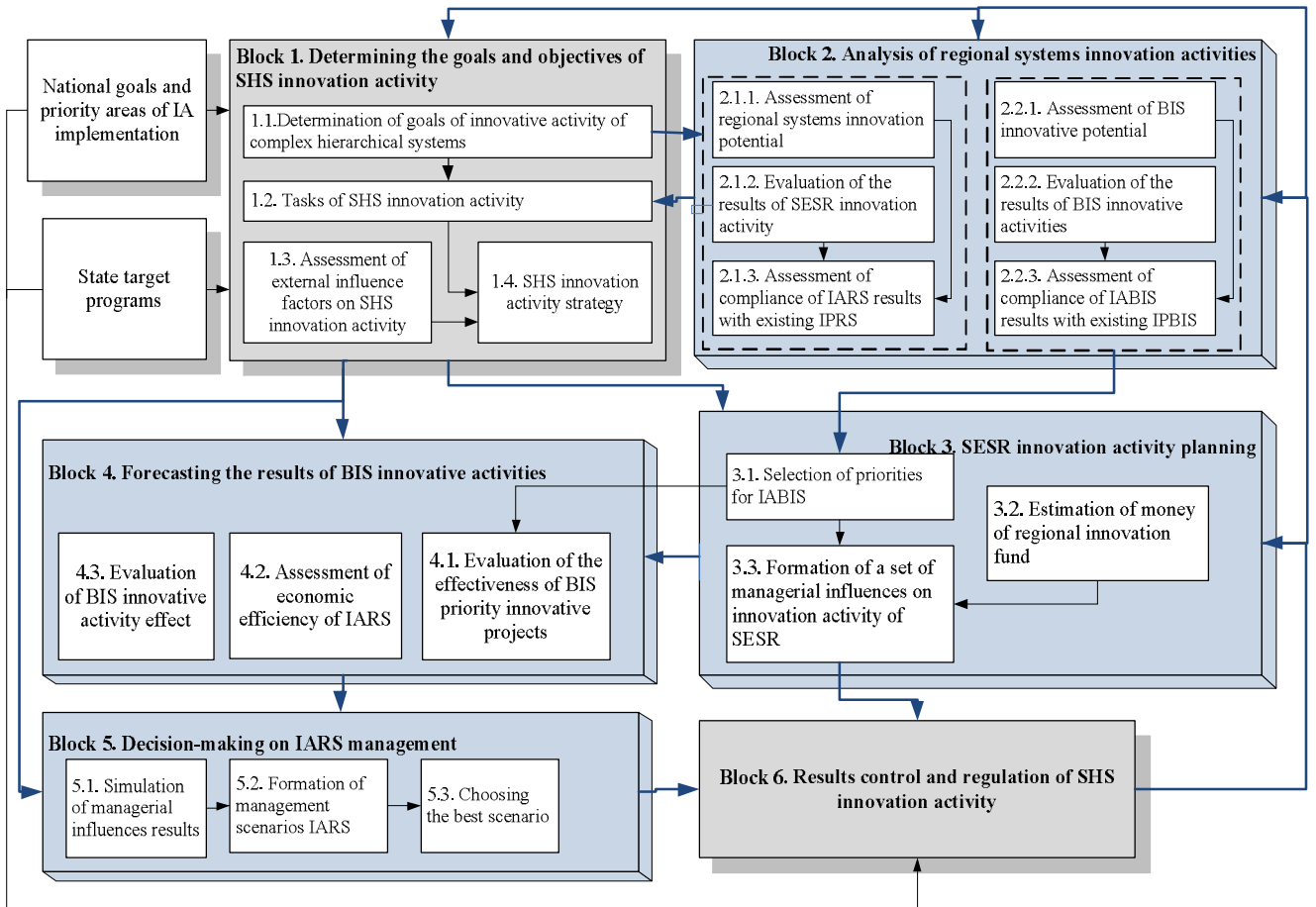

Fig. 1. SHS innovation management mechanism: enterprise - region - state

Financial impact, which finds its expression in the formation of an effective system of stimulation of SESR innovation activity granted by regional (national) innovation Funds is proposed to consider among the vast variety of managerial actions for the implementation of SESR innovation activity.

Using the theory of active systems [22-27] allowed us to build the nonlinear dynamic optimization models to stimulate innovation at the level of regional systems and the state, which take into account both regional features of innovation processes and features of innovation development of BIS and to optimize the distribution of funds to ensure a maximum profit from innovations.

The model of stimulating SESR innovative activity out of the proceeds of the State Innovation Fund (SIF) is as follows:

it is necessary to find the amount of funds allocated to stimulate the IA of the region

$$\sigma_k^t > 0, \quad (1)$$

where $k = 1, \dots, 25$, is that one maximizing the profit function:

$$\Phi^t = \sum_{k=1}^{25} H_k^t(\sigma_k^t, \Delta(\tau, t - \tau)) - \sum_{k=1}^{25} \sigma_k^t \rightarrow \max \quad (2)$$

and meet the conditions:

$$\left\{ \begin{array}{l} \sum_{k=1}^{25} \sigma'_k \leq \Theta^t, \\ \sum_{k=1}^{25} \sigma'_k \geq 0; \\ \Theta^t \geq 0. \end{array} \right. \quad (3)$$

$$\Theta^t = \Theta^{t-1} + \sum_{k=1}^{25} \alpha_k \cdot \Phi_k^{t-1}(\sigma_k^{t-1}) \quad (4)$$

where σ'_k – is the amount of funds aimed at stimulating innovation in the region in the t period, thousand UAH; Φ^t – is total income from innovation activities in the country in t period, thousand UAH; $H_k^t(\sigma_k^t, \Delta(\tau, t - \tau))$ – is an income of the region from the implementation of innovation activities in t period, thousand UAH; $\Delta(t - \tau, \tau)$ – is a function that takes into account the degree of uncertainty of the internal and external parameters; Θ^t – the amount of funds of the state innovation fund in t period, which is formed from the deductions from profits from the innovation activities implementation by k region in the previous period, thousand UAH, α_k – is a weighting factor that reflects the share of funds from the profit from the implementation of the IA of the region, which is transferred to SIF, and is determined by public administration bodies; $\Phi_k^{t-1}(\sigma_k^{t-1})$ – is a profit from innovation activities in the k region in $(t - 1)$ period, thousand UAH.

Therefore, for the effective functioning IARS management it is proposed to improve the mechanism of management of IARS due to the realization of the complex of economic-mathematical methods and models, based on the use of the theory of active systems and optimization techniques. As the management actions it is proposed to use the most effective financial actions. Also, as a part of the study the models for evaluation of innovative capacity, models for evaluation of SERS innovative results, models of dependence of regional systems innovation activity results on innovation potential have been built.

The model of estimation of innovative projects efficiency has been improved and models for assessing the economic efficiency of innovative activities have also been developed.

For the realization of block 2 of the control mechanism of IARS (Fig.1) the system of indicators that comprehensively characterize innovation potential and the results of regional systems innovative activities of business-industrial structures is proposed. Based on a set of indicators in dynamics for 2013-2019 cluster analysis of the regions of Ukraine, the results of which allowed us to distinguish three groups of regional systems in terms of development of innovation potential and the level of development of the innovative results according to high, medium and low levels has been carried out. For analysis of dynamics of innovative processes development in the regional system on the basis of taxonomy defined, the integral indicators of the level of innovative potential and level of SESR innovation, the results of which coincide with the results of clustering have been determined. This is the evidence of the uneven development of innovation activity of regional systems in Ukraine: the occurrence of several leading regions (Kyiv, Kharkiv, Dnipropetrovsk and Donetsk regions) that attract all the financial and intellectual resources when the outsider regions (Vinnytsia, Volyn, Zakarpattia regions) also need the support.

At the same time, the analysis allowed us to conclude that the results of the implementation of IA are directly proportional to the existing innovation potential of a regional system.

The use of correlation-regression analysis allowed to put forward and confirm the hypothesis that the results of SESR's innovation activity depend on the innovation potential: the results of the region's innovation activity in t period (R_t) are proposed to be considered as a consequence of using its innovation potential (P_{t-1}) accumulated by the end of the $(t-1)$ period, i.e. $R_t = f(P_{t-1})$. The hypothesis was tested and confirmed by designing a number of adequate econometric models according to the data of 2013-2019. So, for the last considered period the following dependence was got:

$$R_{2006} = \frac{1}{1 + e^{2.28 - 4.94 * P_{2005}}} \quad (5)$$

The criteria for evaluating the quality of the model confirm the assumptions about the type of relationship between the indicators (Student's criterion was and exceeded the critical value $t_{kp} = 1.71$, Fisher's criterion was $F = 1037.1$, that is more than critical value $F_{kp} = 4.27$, the coefficient of determination equal $R^2 = 0.975$ confirmed the adequacy of the model).

The evaluation of the results of SESR innovation activities (block 4, Fig. 1) begins with an assessment of the effectiveness of specific innovation projects (IP), for which a model that allows the selection of an innovation project as a result of solving a multi-criteria problem based on the previous estimation of IP effectiveness using methods of analysis of investment projects, risk assessment by stages of the life cycle of IP using expert assessment and fuzzy sets is proposed in the article. Thus, a set of priority IP that need funding is selected, and the implementation of which will allow BIS to obtain certain results from the implementation of innovative activities, and the set of such results of business-industrial structures in the region forms the results of IA regional systems.

For the performance of tasks of Block 4 a model of economic effectiveness evaluation of SESR innovation activity using panel data allowing to consider peculiarities of regional development of innovation infrastructure, innovation potential, sector of production, quality of training, and other factors affecting the final result of innovation activity is designed. Table 1 demonstrates the dependences of the volume of innovation products sold (r_{10}) on production factors, combinations of which are determined by the intersection of line (labour costs) and column (cost of capital), and the coefficients of determination value (R^2), which confirm the high quality of the constructed models.

High quality built dependencies allows to predict the economic efficiency of labor and financial resources used for innovation activities in a region. On the basis of the constructed models the indicators of economic efficiency of innovative activities on regional systems, namely average and marginal productivity of resources and the capital-labor ratio are identified. The lowest level of average productivity of manufacturing innovative products in the calculation ths UAH for one specialist performing scientific and technical work, is observed in Poltava region (179,89), the highest – in Zakarpattia (3870,93) and Volyn (1827,1) regions, the medium - in Sumy (794,86), Mykolaiv (729,33), Kyiv (581,54). High values of marginal productivity of innovative production manufacturing by specialists (ths.UAH per one additional specialist) are in Donetsk (495,87), Khmelnytskyi (453,15) and Volyn (376,35) regions; the lowest is in Ternopil (42,28), Kharkiv (39,99) and Kyiv (35,94) regions.

Table 1. Models of the volume of sold innovative products formation

Volume of sold innovative products (r_{10}) thousand UAH		Factors of financial costs	
		total expenditures on innovation activity (p_{25}), thousand UAH	financing of innovative activity at the expense of own funds, funds of the state budget, local budgets, domestic and foreign investors (p_{33-6}), thousand UAH
Factors of labor costs	number of employees of scientific organizations (p_8), persons	$r_{10t} = A_{0k}^{10} p_8^{0.34} p_{25}^{0.48} e_{kt}$ $R^2 = 0.911$	$r_{10t} = A_{0k}^{10} p_8^{0.47} p_{33-6}^{0.34} e_{kt}$ $R^2 = 0.902$
	the number of specialists who perform scientific and technical work (p_{10}), persons	$r_{10t} = A_{0k}^{10} p_{10}^{0.35} p_{25}^{0.48} e_{kt}$ $R^2 = 0.912$	$r_{10t} = A_{0k}^{10} p_{10}^{0.58} p_{33-6}^{0.28} e_{kt}$ $R^2 = 0.897$
	number of inventors, authors of industrial designs and innovation proposals (p_{29}), persons	$r_{10t} = A_{0k}^{10} p_{29}^{0.43} p_{25}^{0.47} e_{kt}$ $R^2 = 0.924$	$r_{10t} = A_{0k}^{10} p_{29}^{0.58} p_{33-6}^{0.33} e_{kt}$ $R^2 = 0.906$

Note: $A_{0k} = e^{a_0 + a_{0k}}$ – effects that reflect both the general innovation climate in Ukraine (a_0), and the peculiarities of development and individual effects of innovation in regions (a_{0k}).

Zakarpattia region (10.81), Dnipropetrovsk region (4.13), Ternopil region (3.65) and Khmelnytsky region (3.48) are characterized by the largest marginal return on production of innovative products (thousand UAH of products per 1 thousand UAH of additional financing). Regions, with the lowest values are Kharkiv (0.55), Rivne (0.49), Cherkasy (0.28).

Using the method of panel data analysis also allowed to build a model of income generation from innovation (r_{21}) depending on the volume of sales of innovative products (r_{10}):

$$r_{21} = \mu_k^1 + 0.0155r_{10} + \varepsilon_{kt}. \quad (6)$$

Student's criterion for the constructed model was $t = 63.67$ and exceeded the critical value, $t_{kp} = 1.71$, the coefficient of determination $R^2 = 0.96$ confirmed the adequacy of the model, Darbin-Watson's criterion was $dW = 2.05$ and confirmed the absence of autocorrelation between the model residues.

Similarly, using panel data, the dependence of income on innovation (r_{21}) on the volume of scientific and technical work (r_1):

$$r_{21} = \mu_k^2 + 0.0057r_1 + \varepsilon_{kt}. \quad (7)$$

For the model (7) the Student's criterion was $t = 255.98$ and exceeded the critical value, $t_{kp} = 1.71$, the coefficient of determination was $R^2 = 0.91$ and confirmed the adequacy of the

model. The Darbin-Watson criterion is equal to $\epsilon dW = 1.91$, which confirms the absence of autocorrelation between the model residues

Variables μ_k^1, μ_k^2 explain individual effects that reflect the effectiveness of innovation and the overall innovation climate in the regions, ϵ_{kt} - errors in model construction.

The high quality of the built models confirms the possibility of using them to assess the effectiveness of innovation processes in regional systems. Analysis of the results and features of the panel data models allowed to make a conclusion about the low level of efficiency in most regions of Ukraine, which indicates the need to improve the management of IA, namely the importance of stimulating innovation in each SESR.

The study builds a model of innovative activity of regional systems BIS. The simulation model of scenarios realization of regional systems innovative activity stimulation has been developed. Scenarios of innovative activity stimulation have been formed and forecast values of economic result from their realization are received. The best incentive scenarios have been identified.

To forecast the effect of the spread of innovations in the system of the region (block 4, Fig. 1), a model of innovation activity of BIS in a region as a probabilistic process of spreading innovations between enterprises as a result of their interaction is proposed.

The basic system of equations of the constructed model has the form:

$$\begin{cases} \Delta S(t) = \left[-6.67 \cdot 10^{-6} \sigma_t + R(t) \left(\beta(t) + 1 - (1 - p_1)^{r \frac{I(t)}{N(t)-1}} \right) \right] \Delta t + \xi^S, \\ \Delta I(t) = \left[13.34 \cdot 10^{-6} \sigma_t + q \times R(t) - \gamma(t) \cdot I(t) \right] \Delta t + \xi^I, \\ \Delta R(t) = \left[\gamma(t) \cdot I(t) - 6.67 \cdot 10^{-6} \sigma_t - R(t) \left(q - \beta(t) + 1 - (1 - p_1)^{r \frac{I(t)}{N(t)-1}} \right) \right] \Delta t + \xi^R. \end{cases} \quad (8)$$

where $S(t)$ - is the number of enterprises of one region that is receptive to innovation (ERI) in the period t , - units $I(t)$ - is the number of innovation-active enterprises of the region (IAE) that are distributors of innovation units; $R(t)$ - is the number of enterprises that are not receptive to innovation (ENRI) in the region, units σ_t - is the amount of funds aimed at stimulating innovation activity in the region, thousands UAH.; $N(t)$ - is the total number of enterprises in the region under the study, units; $\beta(t)$ - is a share of ENRI that restore susceptibility to innovations; $\gamma(t)$ - is - the share of the IAE, temporarily immune to innovation;; q - is a share of ENRI that go into the IAE due to internal changes; p_1 - the probability of innovation SIFfusion, ξ - possible random obstacles in a closed system (the emergence of a new IAP, IAE, or ENRI to the input interference, the elimination of ENRI for output interference).

The designed models of evaluation of innovative potential and the results of innovative activities of business- industrial structures in Kharkiv region (block 2, Fig. 1) as the result of using the methods of taxonomy and cluster analysis provide an opportunity to determine the groups of BIS: IAE, ENRI. On the basis of such classification the intensity of the transitions of business structures from class to class and the probability of innovation fusion (p_1) was determined as intensity of changes of BIS grade.

Model of effect of innovative activity of business-industrial structures was built using the

method of panel data analysis [28, 29], describing the dependence of income on innovation activities (r_{21}) of the total number of innovative enterprises ($I(t)$):

$$r_{21} = \mu_k^3 + 70.614 \cdot I(t) + \varepsilon_{kt}, \quad (9)$$

where μ_k^3 - is individual effects of innovative activities in the region, ε_{it} - is accuracy of the model.

The student's criterion for the model (9) was $t = 27.24$, that is more than the critical value, $t_{kp} = 1.71$, the coefficient of determination was $R^2 = 0.95$ and confirmed the adequacy of the model, the criterion of Durbin-Watson amounted to $dW = 2.1$, which indicates the absence of autocorrelation between the model residues.

3. Simulation of scenarios to identify possible options for stimulating innovation in regional systems

The proposed models for evaluating and analyzing the effectiveness of IARS (1) - (9) became the basis for developing a simulation model for implementing scenarios to stimulate innovation activity of regional systems for decision-making on IARS management (block 5, Fig. 1), consisting of three blocks: formation of state innovation fund, modeling of innovative activity of BIS and evaluation of results of stimulation of regional systems innovative activity (Fig. 2). Blocks 2 and 3 are repeated in the model, according to the number of Ukraine regions, so the simulation model contains 807 variables.

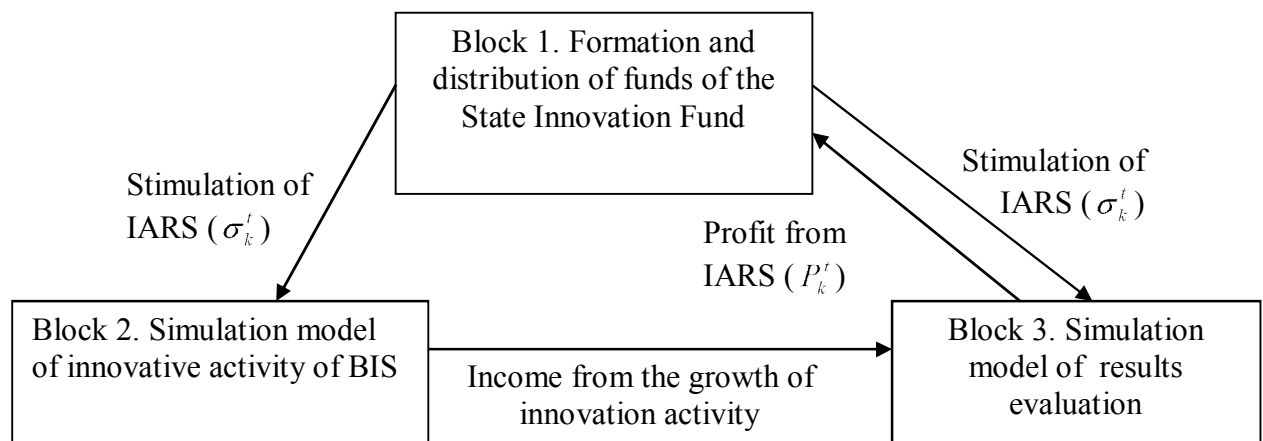

Fig. 2. Scheme of the simulation model of SESR stimulating innovation activity

Along with equations (1)-(9) and functional dependencies, which are given in Table. 1, the main equations of the simulation model are the income functions of k - region, which have the form:

$$H_k^t(\sigma_k^t, \Delta(\tau, t - \tau)) = \frac{\sigma_k^t}{3} [0.0155M_{10,33-6} + 0.0057M_{1,33-6} + 0.00047] + (\mu_k^1 + \mu_k^2 + \mu_k^3 + 2015.606)/3, \quad (10)$$

where $k = 1, \dots, 25$, $H_k^t(\sigma_k^t, \Delta(\tau, t - \tau))$ – is an income of k – region from the implementation of innovative activities in t – period, thousands UAH; σ_k^t – amounts of SIF funds aimed at stimulating IARS, thousand UAH; $M_{10,33-6} = A_{0t}^{10} \cdot 0.33 \cdot p_{29}^{0.58} (\sigma^t)^{-0.67}$ – marginal productivity of manufacturing innovative products, thousand UAH per 1 thousand UAH; $M_{1,33-6} = A_{0t}^1 \cdot 0.09 \cdot p_{10}^{1.07} (\sigma^t)^{-0.81}$ – marginal productivity of scientific and technical works, thousand UAH per 1 thousand UAH; p_{10} – the number of specialists who perform scientific and technical work, persons; p_{29} – the number of inventors, authors of industrial designs and innovation proposals, persons.

Based on the simulation model, 23 scenarios of IA stimulation for 10 years were modeled depending on the share of deductions from the profit of regional systems got from the implementation of IA to SIF, as well as the method of distribution of SIF funds according to the class of a region and ID development implementation. Combinations of parameters allowed to devise scenarios of IARS stimulation on three groups: according to the available FE and results of IA of regional systems; in accordance with the productivity of scientific and technical work in the regions; in accordance with the productivity of innovative products.

Criteria for selecting the best scenarios depending on the goals of innovation were: maximizing profits from innovation, maximizing the number of IAP regional systems and maximizing the integrated assessment of SESR innovation activity results. The results of the best scenarios of IARS stimulation by SIFferent criteria are presented in Table 2. According to the criterion of profit maximization, the best scenario is to stimulate the acceleration of innovative development of SESR in accordance with the productivity of scientific and technical work (profit amounted to 12.12 bln UAH). According to the criterion of maximizing the growth of innovation results, the most effective scenario of IARS stimulation is proportional to IPR during the whole period (Fig. 3), according to which the increase of integrated assessment of IARS results was 3.56%.

Table 2. The results of the most effective scenarios of IARS stimulation on three criteria

Indicators / scenarios	Scenario of stimulation according to productivity of scientific and technical works performance (acceleration of innovative development)	The incentive scenario proportional to the IPR throughout the period	Scenario of stimulation according to FE (scenario of equalization of innovative development of regions)
Profit from the implementation of the IA, UAH billion	12,120	12,005	11,275
The increase in the number of IAP, pcs.	56	58	65
Increase in integrated assessment of IARS results, %	-3,59	3,56	1,48

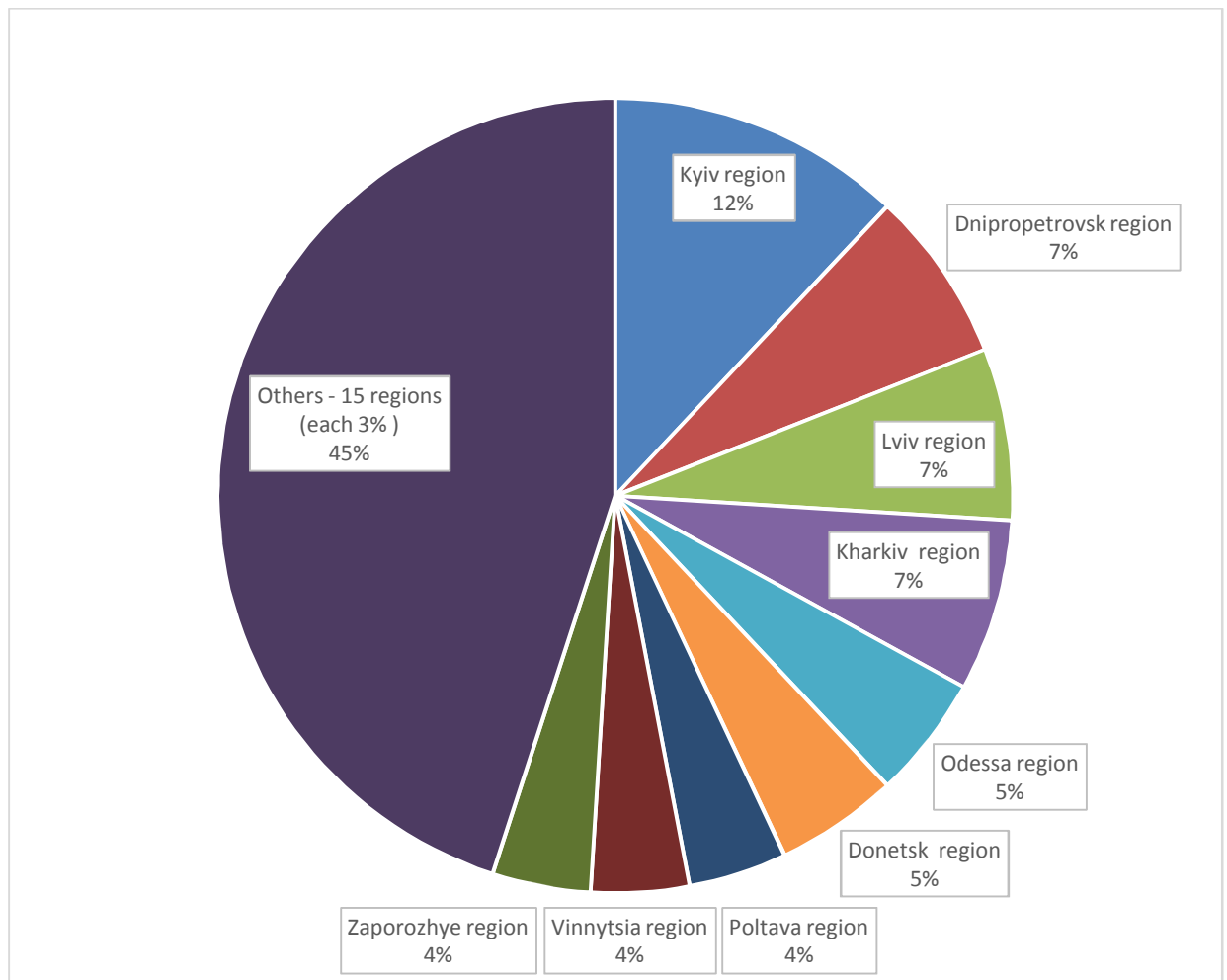

Fig. 3. Chart of distribution of SIF funds according to the best stimulus scenario according to the criterion of growth of innovation activity results

According to the criterion of maximizing the number of IAPs, the best scenario is the stimulus scenario in accordance with the available innovation potential (scenario of equalization of innovative development of SESR) (IAP increase was 65 units). The simulation results also identified the most effective incentive scenarios for selected classes of regional systems. For regions with a low potential and IA results (for example, Sumy region), the most effective scenario is the equalization of innovative development in the allocation of funds in accordance with the innovation potential and with differentiated shares of contributions to SIF. For regions with a medium innovation potential and results of innovation activity (Zaporizhzhya region) the best scenario is the acceleration of innovative development with funds allocated in accordance with the productivity of scientific and technical work in the regions with SIF differentiated shares of SIF contributions. For regions characterized by a high innovation potential and results of IA (Kharkiv region) the most attractive is the scenario of distribution of SIF funds in proportion to the accumulated innovation potential with a constant share of deductions from IA revenues.

Thus, the forecast values of economic results got from the implementation of scenarios for stimulating innovation in the regions have been obtained and the most effective in terms of the main management criteria have been identified.

Conclusions.

1. The analysis of innovative activity in Ukraine indicates the decline in innovation activity of enterprises, which is associated with the inefficiency of the administrative-organizational structure of management of science, technology and innovation activities, as well as priority financing of innovative activity of business-industrial structures at their own cost and expense. The results of the analysis of a condition of innovative processes management in the country confirmed the objective necessity of designing a complex of models of innovative activity management of regional systems.

2. The mechanism of innovative activity management of complex hierarchical systems: an enterprise – a region –the state, based on the application of complex economic-mathematical models, provides a solution to such basic tasks as: the analysis of existing innovative potential of the regional system; the analysis and selection of promising from the standpoint of innovation projects, business and industrial structures, evaluation of their effectiveness, the analysis of innovative activity of entrepreneurial structures in the region, forecasting of results of regional systems innovative activity, adoption of decisions on management of innovation and assessment of their effectiveness for each subsystem and the whole country.

3. A model of stimulation of innovative activity at the state level, which takes into account the regional peculiarities of the development of innovative processes and the level of development of its innovative potential is designed. The model is based on the review of the system of management of SESR innovative activity as an active system of a specific type, which stands on public administration as the top-level element, the regional administrations as the subjects of management of the second level, which interact in the process of implementing innovations.

4. The analysis of the innovative activities of the regional systems of Ukraine has allowed to propose a system of indicators that comprehensively characterizes innovation potential and results of SESR and BIS innovative activity and to design a model of their assessment using the method of taxonomy. For the comparative analysis of the innovation potential and results of its usage, a set of nonlinear econometric models, which allowed to conclude that the low use of capacity in most regions of Ukraine, indicating the need to stimulate innovation in the whole country has been developed.

5. To assess the efficiency of innovative projects the model based on the use of fuzzy set theory and methods of solving multicriteria problems, taking into account the risks inherent in a particular stage of the innovation life cycle is proposed.

6. To build models of economic evaluation of regional systems innovative activity the method of panel data analysis that takes into account the characteristics of regional innovation infrastructure development, innovative potential, the sectoral focus of production, quality of training, and other factors affecting the final result of innovation activities, and evaluate the effectiveness of the use of human and financial resources was used.

7. To assess the impact of state stimulation of innovation activities on the growth of the number of innovative-active business-industrial structures and the assessment of income from IA implementation, the model of innovative activity of enterprises, which takes into account the probabilistic nature of SIFfusion of innovation as a result of interaction of enterprises has been designed.

8. On the basis of the developed complex of models of estimation of IARS efficiency stimulation, the simulation model of implementation of the scenarios that stimulate IA from the funds of the CIF, which allows to evaluate the effectiveness of the ongoing management of IARS for the developed scenarios has been designed. On the results of the scenario analysis the predicted values of the results of their implementation have been obtained and the best scenarios of IARS stimulation according to the main criteria have been identified.

References

1. Gerasimchuk, SV, Kovalevskaya, LL. (2003). Productive Potential of the Region: Methodology of Evaluation and Mechanism of Building up: Monograph. Lutsk, 242.
2. Kobushko I.M., Guseynova E.I. (2003). (2011). Ways to improve financing of innovation development in Ukraine using international experience. *Marketing and Management of Innovations*, 2 (124), 124.
3. Martynenko V.F. (2013). State Management of Investment Process in Ukraine in the Context of Globalization of Economy. *Scientific Journal of the Academy of Municipal Management. Management" Series*, 4, 41-50.
4. Zabrodskaia L. (2015) Innovation priorities of scientific and technological development: international and regional aspects. *Theory and methods of educational management*, 2 (16)
5. Moskovkin V. M., Laktionov AA, Rakovskaya-Samoilova AH (2004). Methodology of Assessment of Integral Indicator of Innovation Activity of Regions of Ukraine with Implementation of EU Approaches. *Problems of Science*, 6, 7-14.
6. Tarasyuk M.V., Malyarchuk A.V. (2017). Current state of implementation of innovation policy of Ukraine and its financial support. *Economic science*, 1, 19-24.
7. Ten types of innovation. (2015). URL: <https://www.doblin.com/ten-types>
8. Yakovlev A. I. (2018). Analysis of innovation activity in Ukraine and ways to improve it. *Science and Science Studies*, 2 (100), 29-44.
9. Onegina V. Onegina V.M., Luneva V.A. (2015). Innovation potential of enterprises and state policy. *KNTUSG Bulletin: Economic sciences*, 161, 50-59.
10. On scientific and technical expertise: Law of Ukraine from February 10, 1995 N 51/95-VR / Verkhovna Rada of Ukraine. URL: <http://zakon.rada.gov.ua>
11. On scientific and scientific-technical activity: Law of Ukraine from November 26, 2015 № 848-VIII / Verkhovna Rada of Ukraine. URL: <http://zakon.rada.gov.ua>
12. On special regime of innovation activity of technological parks: Law of Ukraine dated July 16, 1999 N 991-XIV / Verkhovna Rada of Ukraine. URL: <http://zakon.rada.gov.ua>
13. On priority directions of science and technology development: Law of Ukraine from July 11, 2001 N 2623-III / Verkhovna Rada of Ukraine. URL: <http://zakon.rada.gov.ua>
14. On innovation activity: Law of Ukraine dated July 4, 2002 N 40-IV / Verkhovna Rada of Ukraine. URL: <http://zakon.rada.gov.ua>
15. On priority directions of innovation activity in Ukraine: Law of Ukraine dated September 8, 2011 No. 3715-VI / Verkhovna Rada of Ukraine. URL: <http://zakon.rada.gov.ua> (date of address: 15.01.2020).
16. On the National Complex Program of High Technologies Development: Law of Ukraine dated April 9, 2004 N 1676-IV / Verkhovna Rada of Ukraine. URL: <http://zakon.rada.gov.ua>
17. About creation of the regional centers of innovative development: Decree of the Cabinet of Ministers of Ukraine from May 3, 2007 N 255-r. URL: <http://zakon.rada.gov.ua>
18. Artemenko L. II. (2015). Influence of European Integration on Competitiveness and Innovative Development of Countries. *Economics. Management. Business*, 2 (12), 84-89.
19. Oleinik, L.V. (2017). Management of Innovative Development of Enterprise on the Basis of Formation of Innovative Programs. *Economics and organization of production*, 3, 51-59.

20. Kviatko T.M., Ryzhikova N.I. (2017). Genesis of Competition Theories and Applied Basics of Their Implementation in Innovative and Investment Development of Social and Economic Systems. *Problems of Innovative Economy*, 4, 45-54.
21. Karpets O. S. (2008). Scenario Modeling of Regional Innovation Activity Management. *Business Informational*, 8, 26-29.
22. Translated with www.DeepL.com/Translator (free version)
23. Cooke Ian, Mayers P. (1996). Introduction to innovation and technology transfer. Boston: *Artech House Inc.* 126.
24. Dodgson M. J. W. (2001). Statistical physics of phase transitions (lecture notes). 72.
25. Freeman C. (1995). The national system of innovation in historical perspective. *Cambridge Journal of Economics*, 19(1), 5-24.
26. Freeman C., Clark J., Soete L. (1982). Unemployment and technical innovation. A study of long waves and economic development. L.: *Frances Pinter*, 15-20.
27. Innovation Union Scoreboard (2014). URL: http://ec.europa.eu/enterprise/policies/innovation/policy/innovation-scoreboard/index_en.htm
28. Reamer A., Icerman L., Youtie J. (2003). Technology transfer and commercializations: Their role in economic development U.S. department of commerce report. *U.S. Economic Development Administration*. 84.
29. Baltagi Badi H. (1995). Econometric analysis of panel data. New York: *John Wiley&Sons Inc.*. 253.
30. Wooldridge Jeffrey M. (2001). Econometric analysis of cross section and panel data. M: *MIT Press*. 752.

Alina Tkachenko

*PhD, Associate Professor, Dean of Faculty of Commodity, Trade and Marketing,
Poltava University of Economics and Trade, Ukraine*

PROSPECTS OF UKRAINE ON THE EUROPEAN ORGANIC FOOD PRODUCTS

Abstract. *The article discusses changes in the prospects for the development of the organic food market in Ukraine and the world. The history of organic farming in the world has been investigated. A detailed analysis of world production and consumption of organic products was also carried out. Germany is estimated to have the largest organic produce market by volume of EUR 8.6 billion, France - EUR 5.5 billion, the United Kingdom and Italy - EUR 2.6 and 2.3 billion, respectively. It was found that the largest volumes of organic products were shipped from Ukraine to Germany (39.68%), Poland (17.61%), Switzerland (15.49%), the Netherlands (8.39%) and Austria (6.85%). As Ukraine is a promising supplier of organic products, a study of Ukraine's export potential on its organic market has been conducted and a SWOT analysis of Ukraine's export potential has been conducted. On the basis of this analysis the main directions of the strategy of promotion of organic products are determined. In particular, it is a search for partners, an information campaign for the community, financial and legislative support at the state level, the formation of a positive image of organic producers. The algorithm of promotion of organic products by Ukrainian enterprises is defined.*

Introduction

The expansion of the market for prepared organic food is quite promising. As the market for organic produce of primary production in Ukraine is rapidly developing, the question arises as to the expansion of the range, in particular flour confectionery. Such a conclusion can be made according to the Ministry of Agrarian Policy and Food. For example, there are more than 420 organic and transitional operators in Ukraine, including 294 agricultural producers. Most organic operators in Ukraine are certified according to an EU organic standard equivalent to EU Regulations 834/2007 and 889/2008, which is applicable both to organic exports and to the internal market. The above data underline the feasibility of exploring Ukraine's prospects in the global organic produce market.

1. History of the organic farming

As defined by the International Federation of Organic Agricultural Movement (IFOAM), organic farming is an agricultural system that promotes the environment, socially and economically supports the production of healthy food, fiber, etc. It avoids the use of chemically synthesized fertilizers, pesticides, veterinary preparations, while actively using natural natural preparations in order to increase the natural fertility of soils, plant and animal resistance to diseases. (Mylovanov, 2009). In fact, organic agriculture originated in the so-called "primitive" civilization, going back 12,000 years. However, in the early 20th century, agrochemicals were widely used in agricultural production. But over time, mankind began to become aware of the threat of chemical fertilizers, prompting the search for alternative methods of agriculture. Such methods include Precision Farming, Biointensive Mini-Farming, Biodynamic Agriculture, Effective Microorganism Technologies or Effective Microorganism Technologies, Low Input Sustainable Agriculture and others. These methods include organic farming (Organic Agriculture or Organic Farming). The main ideologists of organic production at the beginning of its development were Rudolf Steiner (Austria), and later developed Masanobu Fukuoka and Mokishi Okada (Japan). British botanist Albert Howard, who held the position of advisor to India's agriculture, has hypothesized that natural farming practices take precedence over conventional ones. In 1943, an agricultural testament by Albert Howard described the "law of return", which later began to define agriculture (A. Howard, 1943).

Albert Howard explained that, for example, in the forest, the remains of dead animals and plants return to the soil, enriching it with organic material, that is, humus. All the necessary minerals circulate in this natural process so that new plant populations differentiate classes and species to have enough nutrients in their life. He stressed that the key to renewable agriculture is the constant presence of organic residues, including waste and effluents of livestock complexes. He also claimed that this "bridge of life" supports plant and animal health. However, his position has given rise to the erroneous notion that the term "organic farming" is defined simply as a method of farming that does not allow the use of artificial fertilizers.

Eva Belfort initiated in 1939 an experiment near the town of Huffley (Suffolk County, United Kingdom). Two opposite farms were involved in two opposite directions - organic and conventional production - which were regularly monitored and verified. It was the first such study of its kind. The results of the research were published in the book *Living Earth* in 1943, which was the impetus for the establishment of the Soil Association, an organic movement advocacy group in the United Kingdom. The Soil Association was founded in 1946 by a group of people concerned about the health implications of the growing intensity of agricultural systems after World War II. Their main problems were:

- loss of soil due to erosion and exhaustion;
- decrease in food quality;
- operation of animals;
- impact on the countryside and wildlife.

For the first 30 years, the Soil Association was founded on a farm in Suffolk, where it was divided into three sections. The first part of the economy used methods of intensive agriculture, the second – traditional systems, and in the third - a mixture of both.

Organic production certification systems began in 1973 due to increased consumer requirements to confirm that the food is of high quality and safe. The Association certifies organic products and so far – 70% of organic products produced in the UK are certified by the Soil Association.

In the mid-1980s, supermarkets began to supply organic food, which became an organic movement. However, the number of organic farmers remained low until the organic aid scheme began in 1995. For example, in the UK, at this time, the government is helping farmers organize organic production. Thus, demand for organic products is increasing in the UK. A large proportion of organic products are presented in supermarkets, and new specialty stores have begun to appear.

In the United States, the founder of the organic movement is J.I. Rodale, who is also the founder of the Scientific Institute of Rodal and the journal "Organic Agriculture and Horticulture." Since the 1940s, Rodale has been exploring "non-chemical" farming practices. Rodale developed the ideas of British scientist Albet Howard.

By the 1970s, increased environmental awareness and consumer demand had contributed to the growth of the organic industry in the United States. However, the new organic industry has been in increasing pain. Despite the general agreement on philosophical approaches, there were no standards or rules for defining organic agriculture. The first certification programs were decentralized, meaning that each state or certified agent could set standards based on manufacturing practices and restrictions in their region. The downside to this decentralized approach was the lack of clarity on what constitutes "organic" from the state government. There is a growing movement to develop a national organic standard that helps promote interstate marketing.

In response, Congress passed the Organic Food Production Act (OFPA) in 1990 to develop a national standard for the production of organic food and fiber. The OFPA has mandated the USDA to develop and write rules to explain the law to manufacturers, processors, and certifiers. The OFPA also called on the advisory board of the National Organic Standards Commission to provide guidance on substances that could be used in organic production and processing. The final rules were written and approved in the fall of 2002.

Although actual technologies for organic food production have not changed significantly since national standards were implemented, "organic" is now a labeling term that indicates that food has been grown in accordance with the federal principles of the Organic Food Production Act. National standards also state that any grower who sells \$ 5,000 worth of agricultural produce annually and wants to label their produce "organic" must be certified by a USDA accredited agency. Companies that process organic products must also be certified.

Any farms or processing operations with less than \$ 5,000 a year in organic agricultural products are exempt from certification. These manufacturers can label their products organically if they comply with the standards, but they are prohibited from using Organic Seal USDA (History of Organic Farming in the United States).

It is worth noting that organic production in Ukraine began to develop in the Soviet era. Thus, in 1976, organic production was introduced in the collective farm. Ordzhonikidze (Mykhailyky village) under the leadership of Semyon Antonets (Pysarenko, V.V., 2008).

Semyon Antonets created his own model of the organic farming system, whose philosophical foundations became the conceptual foundations for the development of the biosphere. The philosophy of the organic farming system of Semyon Antonets is based on the creation of agroecosystems that are as close as possible to natural formations. The system takes into account the basic principle of planet development, since the emergence of life on Earth was provided by two global processes that will continue to support the development of the biosphere today and in the future. They include photosynthesis and nitrogen fixation in all its manifestations. Organic agriculture is the most regulated of these processes, since its technological techniques ensure the effective use of positive environmental factors, first of all, by increasing their share in the production of basic biotic components. The technological measures of the system are based on:

- scientifically sound structure of acreage and specialized crop rotations with saturation of perennial legumes up to 25-27%;
- fine tillage that preserves the natural structure of the plow layer without destroying the vertical orientation of the aeration pores in it;
- use of perennial legumes, siderates and introduction of scientifically-based standards of organic fertilizers, which provides plants with nutrients and a positive balance of humus;
- application of ecologically safe agro-technical and biocenotic measures in the technologies of cultivation of crops (Pysarenko P.V., 2017).

In Japan, microbiologist Massanobu Fukuoka in the early 1940s focused on the development of organic methods of growing grain. This natural farming method, which does not require pesticides, fertilizers, weeding and special care, is now known as Fukuoka agriculture.

During the 1940-1978 period, there was constant debate between organic and conventional farmers. Jerome Rodeil, an American businessman and publisher, experimented with organic production and composting technologies. The international campaign, later dubbed the Green Revolution, began in 1945, helping to raise public awareness of conventional farming methods: the

use of chemical fertilizers, herbicides, pesticides made from petroleum products. This practice has been sharply criticized by society for its destructive effects on the environment. In 1962, Rachel Carson published her own work, *Silent Spring*, which linked the birth of the international environmental movement. The main theme of the *Silent Spring* is the enhancement and often negative impact of human activity on the outside world. Carson's main argument is that the effects of pesticide use are often detrimental to the environment as a whole, and not just to the pest species against which they are used, and such chemicals will be more properly called biocides. In the first place, such effects have the use of DDT, but this book addresses other synthetic pesticides, many of which also have a cumulative effect. Much of the book is devoted to the effects of pesticides on natural ecosystems, but four chapters describe the identified cases of pesticide effects on human health, including poisoning, cancer and other diseases that can be caused by toxic chemicals.

In 1972, one of the most powerful organizations in the world was founded, the International Federation of Organic Agricultural Movements (IFOAM), which brings together participants from more than 100 countries. The organization was founded in 1972 in Versailles, France. Roland Schweizer envisaged the need for organic farming to coordinate and provide scientific and experimental data on the global community. To realize this vision, he invited the sponsors of the organic movement, including Lady Eva Balfour, Kell Arman of the Swedish Biodiamics Association and Jerome Goldstein of the Rodal Institute, to join him in Versailles and start the International Organic Farming Federation. Given the growing problem of environmental pollution, the distinction between organic and conventional agricultural production has become a tipping point, thereby increasing the popularity of organic principles and methods. As early as the early 1980s, consumer associations began to press their governments to define a clear regulation of organic production, resulting in the adoption of organic certification standards.

Today's consumers are not only concerned with the environmental pollution caused by chemical farming methods. There is also increased concern about the quality and safety of food and clothing, the vast majority of which contains pesticides and poison chemicals.

In advanced economies, not only do consumers prefer organic products, but many producers, including organic products, are in the service industry. Yes, London's Rits Hotel is the first in the UK to introduce organic food at its restaurant. This decision by the Rits management was in response to growing consumer demand, as it became fashionable to eat healthy food. The initiative was supported by hotel business professionals who want to attract customers, supporters of organic consumption, offering modern and prestigious service.

In many countries, there is a growing popularity of medical clinics that offer patients individualized healing techniques, based in particular on organic food and active rest. Beauty salons, children's wellness camps are also increasingly applying the principles of organic products (Parkhomenko M.M., 2011).

Since the 1990s, the retail market for organic products has grown by 10-20% annually. Along with organic food, there is an increasing demand for safe, non-chemical household products, such as cleaning products. The "Movement for a Green Future" has become widespread and ubiquitous. In the 1990s, various organic support programs were actively implemented in Europe and the United States. In different countries, the programming documents have different names ("Action Plan for the Promotion of Organic Foods", "Action Plan for the Further Development of Organic Agriculture", "National Organic Program"), but their essence is to create a single system of measures by the state and private structures aimed at the qualitative growth of organic agriculture in

the state. Similar development programs were introduced in Europe and the USA in the mid-1990s: Norway in 1995; Finland, the Netherlands and Sweden in 1996, France in 1997, USA – in 1999.

In the late twentieth - early twentieth centuries. The attention of government officials and businessmen from different countries is increasing to the promising market for organic products, state market regulation systems are being developed, national standards and certification systems are being developed, dynamic development of the organic produce market is taking place and annual growth rates are noted (Artysh V.I., 2012). Organic production is now being promoted by the International Federation for the Organic Agriculture Movement, which brings together participants from 108 countries (Tomashevskaja O.A., 2013).

Organic production is an overall system of farm management and food production that contributes to the preservation of natural resources and applies high animal welfare and production standards.

2. Prospects of Ukraine on the food organic market

Demand for organic products in the EU countries is far outstripping supply, so its large volumes are exported from Ukraine to these countries for further processing and consumption, and Ukrainian organic exporters continue to be one of the most important suppliers in the international market (Galashevsky S.O, 2019). In 2017, 69.8 million hectares were organically cultivated (including area, transition). In 2017, 12.6 million hectares were cultivated in the European Union, representing 18% of the world's organic area and 7% of the total EU agricultural area. The impressive growth of organic produce by 70% over the last ten years indicates the need to develop the organic produce market. More than half of the EU's organic land is concentrated in four countries: Spain, Italy, France and Germany. But the area of organic land is the leading countries - Austria (23%), Estonia (20%) and Sweden (19%).

Analyzing the world market for organic products, it is worth noting that its main market trends was the increase in demand for organic products in most countries. The situation in the global organic market is characterized by concentration of demand in developed countries, increasing demand in developing countries, consolidation of market participants and the development of distribution of organic products. In Fig. 1 presents the dynamics of organic food and beverage sales and organic land sales from 2006 to 2016, according to Ecovia Intelligence.

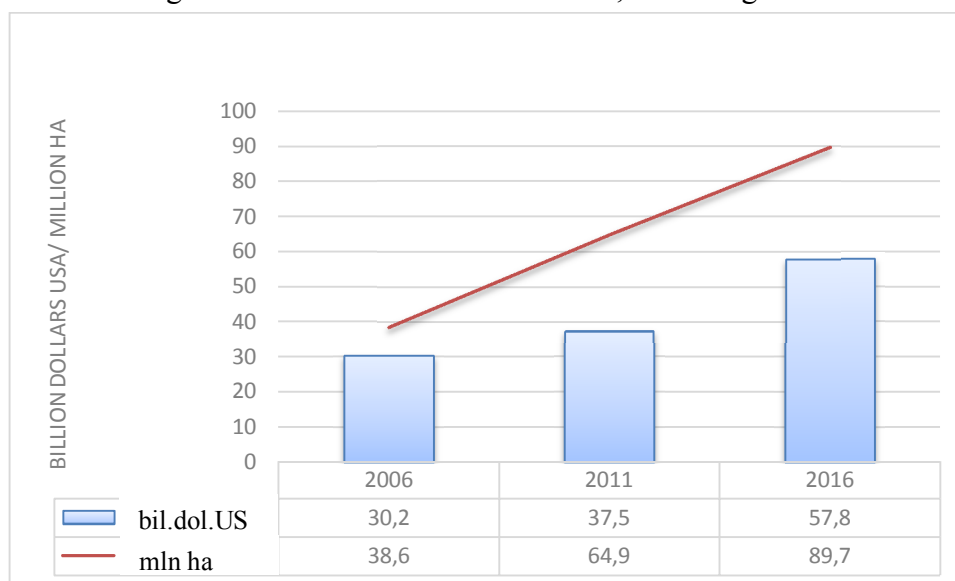

Figure 1. Dynamics of Organic Food and Beverage Sales and Area of Organic Lands in the World from 2006 to 2016

As can be seen from Fig. 1, the global upward trend in organic food demand has almost doubled in 10 years. There is also an increase in organic land, which is also indicative of the popularity of organic production among the world's population.

In 2015, organic farming was conducted by 179 countries. Australia, Argentina, the United States, Spain, and China ranked in the top five in terms of organic land as of 2015 (Figure 2).

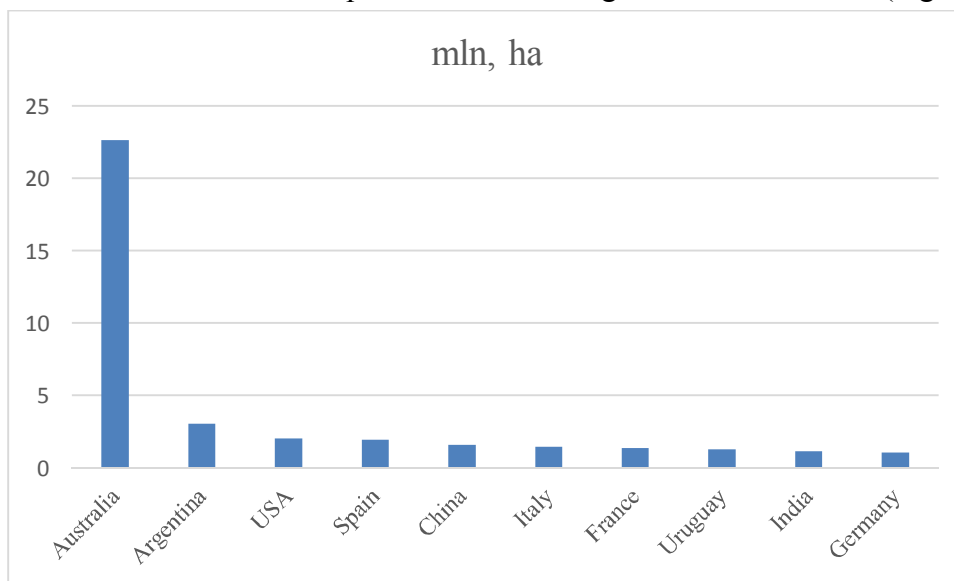

Figure 2. Leader countries by area of organic land, 2015

Europe is generally a promising market for Ukrainian organic food producers. At the same time, European citizens are active consumers of organic products. Organic experts say that in 2015, the organic market in Europe grew by 13% to EUR 30 billion, and the number of organic lands increased by 8%. Figures on organic market leaders in the EU countries for 2015 are presented in Fig. 3.

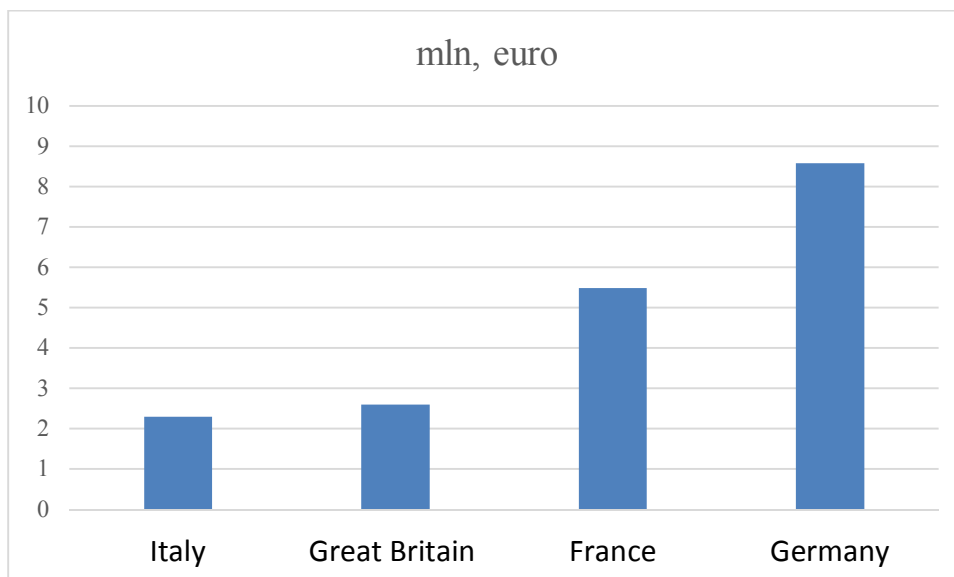

Figure 3. Organic product market volumes in EU countries, 2015

As can be seen from Fig. 3, the largest organic produce market is Germany with EUR 8.6 billion, France – EUR 5.5 billion, the United Kingdom and Italy – EUR 2.6 and 2.3 billion, respectively. Such data indicate that the organic market in Germany, France and Italy is developing quite dynamically, especially given the fact that the countries listed above are among the top ten

countries by area of organic land. At the same time, the UK is one of the leaders in organic consumption in Europe, although this country is not very different from organic land. This suggests that the UK is a promising market for Ukrainian organic produce. In addition, Canada, which is a country friendly to Ukraine, can be a promising market for organic products (Fig. 4).

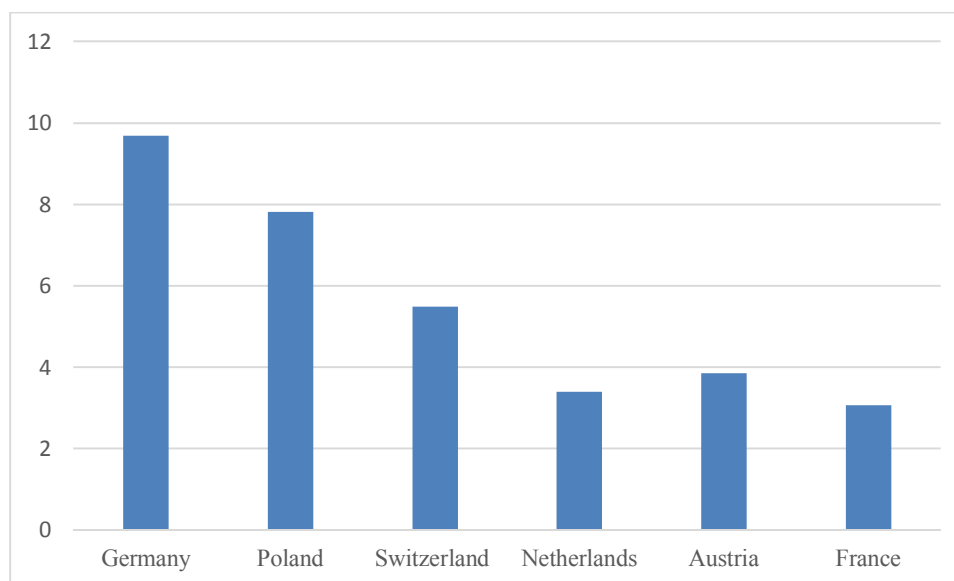

Figure 4. Shares of importing countries of Ukrainian organic products

According to Organic Standard, in 2017, Ukrainian enterprises exported organic products to 14 countries, most of which are European Union countries. The largest volumes were delivered to Germany (39.68%), Poland (17.61%), Switzerland (15.49%), the Netherlands (8.39%) and Austria (6.85%). This indicates that the main partner in sales of organic products for Ukraine is the European Union, so new producers should focus on exports to this region.

Currently, export flows of Ukrainian manufacturers are focused on Western countries, but there are a number of problems with export deliveries, in particular to European countries, due to the non-compliance of domestic technical regulations. In addition, due to the imperfection of state market surveillance, a significant proportion of counterfeit, "pseudo-organic products" gets into the market, which undermines the credibility of Ukrainian producers both in the domestic and foreign markets. Despite the overall fall in exports, exports of organic products increased significantly from 2012 to 2016 (Figure 5).

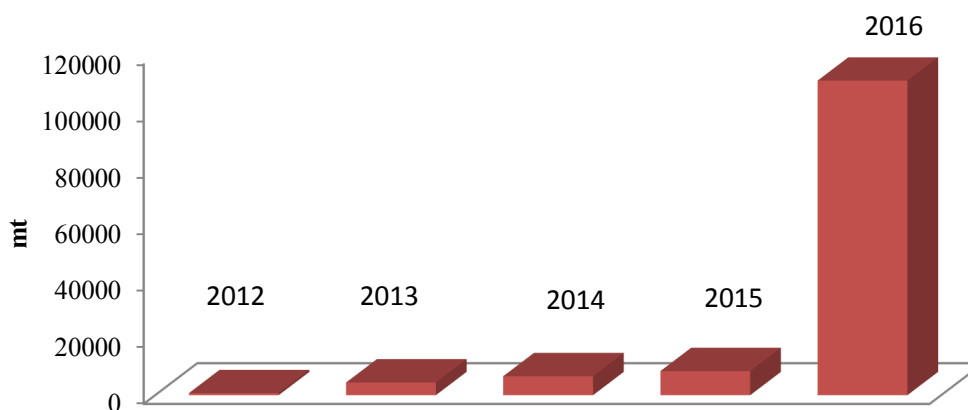

Figure 5. Volume of organic exports from Ukraine, 2012–2016

Thus, according to Fig. 8, exports of organic products in 2016 increased 151 times compared to 2012. Increasingly, organic products are exported annually to Ukrainian producers, which, in our opinion, is associated with both an increase in production and the promotion and consumption of organic products in the world. In addition, Ukraine is a profitable partner for the EU countries, although European companies also consider countries such as Russia and Kazakhstan as important strategic partners in the supply of organic products in exchange for raw materials from China. However, Ukraine's favorable geographical location allows it to be supplied by road or rail, or by sea - by ship or barge. Crops exported to Ukrainian enterprises: millet, spelled, collapsed and unroasted wheat (spring and winter), frozen blueberries, oats, buckwheat, corn, lupine, apple concentrate, pumpkin seeds, rye, kernel and sunflower seeds, barley, barley, mustard, soy, flax.

Ukraine is a promising supplier of organic food to the European Union. In recent years, organic exporters in Ukraine have received support from international funds, including:

1. The Swiss-Ukrainian project "Organic Market Development in Ukraine", implemented by the Research Institute of Organic Agriculture (FiBL, Switzerland) with the financial support of the Swiss Confederation through the State Secretariat of Switzerland for Economic Affairs (SECO).
2. The German-Ukrainian Cooperation in Organic Farming Project.
3. Better Regulation Delivery Office (BRDO).
4. EU project "Support to implementation of agricultural and food policy in Ukraine".
5. Swiss-Ukrainian program "Development of Trade with Higher Value Added in Organic and Dairy Sectors of Ukraine".

It should be noted that state support and support for organic sector production by Western funds stimulates domestic enterprises to develop this particular segment of the organic food market. For example, 37 companies represented Ukraine at the world's largest exhibition of organic food BioFach in 2020. The most common among Ukrainian organic food products are cereals and legumes, oil, berries, juices. According to Organic Ukraine, as of 2017, the leaders of the organic sector in Ukraine are LLC Organic Milk (TM "Organic Milk") and LLC "Stary Porytsk" (TM "Staroporitskoye") – producers of dairy products. In the third place – Ethnoproduct LLC (Ethnoproduct TM) – meat, milk, grain. The fourth is Organic Original LLC (TM "Ekorod") – groceries, fifth – "Galex-Agro" which is export-oriented grain producer.

As of June 1, 2016, there are 239 enterprises registered in the organic sector, of which 162 are agricultural producers. The consumption market is most developed in big cities – Kyiv, Odessa, Lviv, Kharkiv, Dnipro.

LLC "Staryy Porytsk" is an agricultural enterprise whose purpose is to maintain and develop organic production. The farm operates in two main areas: dairy farming and crop production. The production includes cheese, brine and butter.

LLC "Grocery Factory" covers more than 80% of the Ukrainian premium cereals market. Includes the products of the trademarks "Zhmenko", "Sladov", "Salute di Mare".

LLC "Organic Original" is a producer of organic products of TM Ekorod, which includes cereals, flour, watermelons, melons, sunflower oil, honey.

EthnoProduct, a private joint-stock company, is a Ukrainian-Swiss agricultural enterprise with a closed production cycle of organic agricultural products. Organic lands are located in the northeast of Chernihiv region of Ukraine, where about 4000 hectares of organic land (pastures, hayfields, arable land) are cultivated. The dairy processing plant produces ready-made organic food under its own trademark "EthnoProduct". In general, organic products produced by the enterprise

include: raw milk, pasteurized milk, sour cream, kefir, low-fat kefir, low-fat yogurt, honey, meat, sausages, vegetables, as well as cereals and legumes.

Galex-Agro (Zhytomyr Oblast) is a company engaged in growing wheat, polby (polby), rye, barley, oats, beans, wiki, buckwheat, millet, soybeans, corn.

Thus, today the domestic organic food market is represented mainly by dairy and grain products. Expanding the range of confectionery and fruit and berry organic products is promising.

Considering the peculiarities of the organic market, before starting the export of organic products, Ukrainian enterprises should analyze their opportunities to enter foreign markets. We propose the following model of export capability analysis by Ukrainian enterprises (Fig. 6).

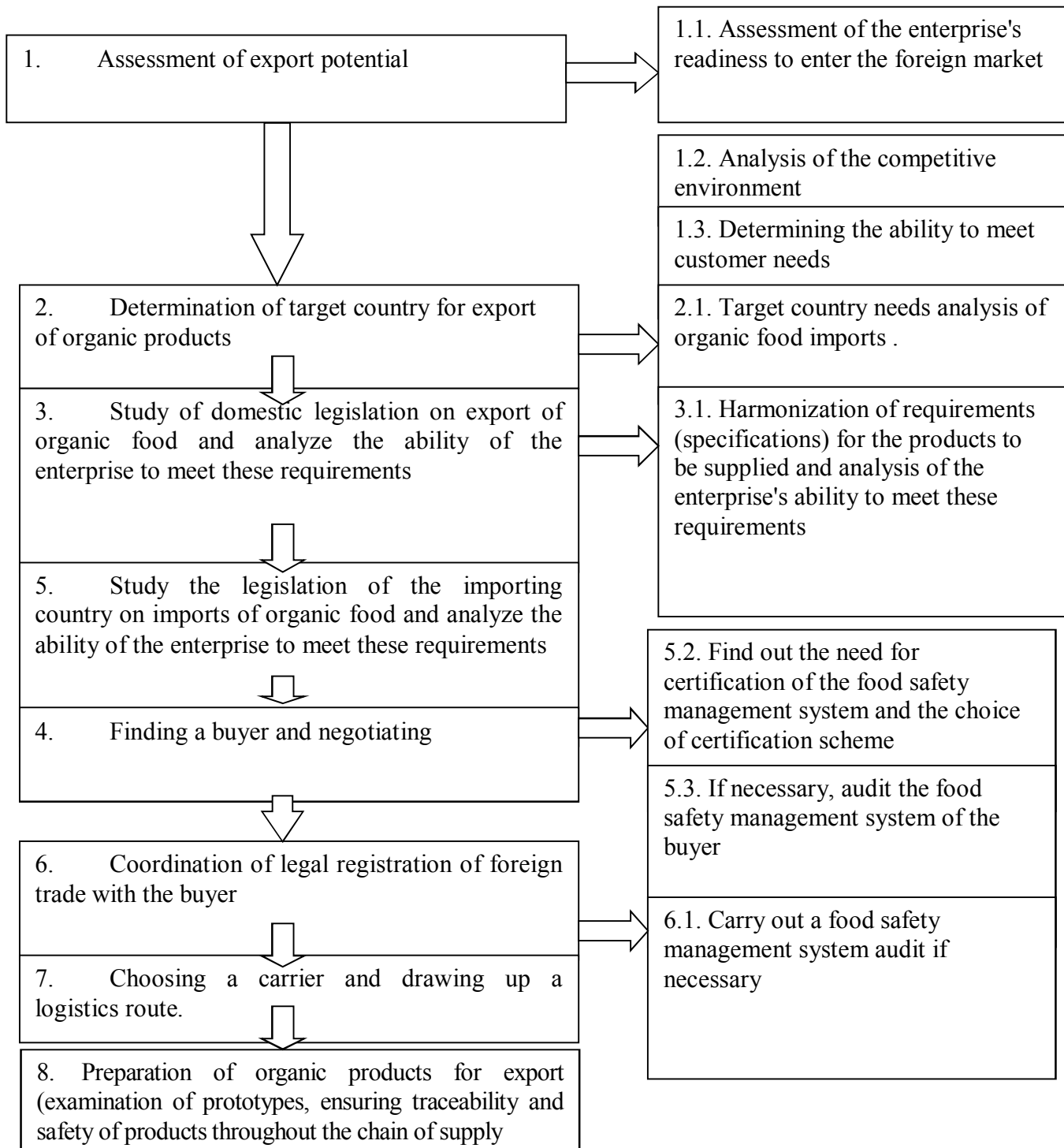

Figure 6. Model of export capability analysis by Ukrainian enterprises

Ukraine has already established itself in the world market as an exporter of raw materials for food products, in particular grains and oilseeds, which, in our opinion, will greatly simplify the search for foreign partners to buy agricultural, not traditional, but organic products. It is worth noting that Ukraine is increasing the number of organic lands, and the expansion of the market for organic products leads to the search for new markets. Despite the slight decline in the growth rate of organic land over the last three years, the volume of organic farming has been increasing overall. Most Ukrainian organic farms are located in Odesa, Kherson, Kiev, Poltava, Vinnytsia, Zakarpatska, Lviv, Ternopil, Zhytomyr regions. Along with the increase in the number and areas of organic land in Ukraine, the capacity of the consumer market has also increased (Fig. 7).

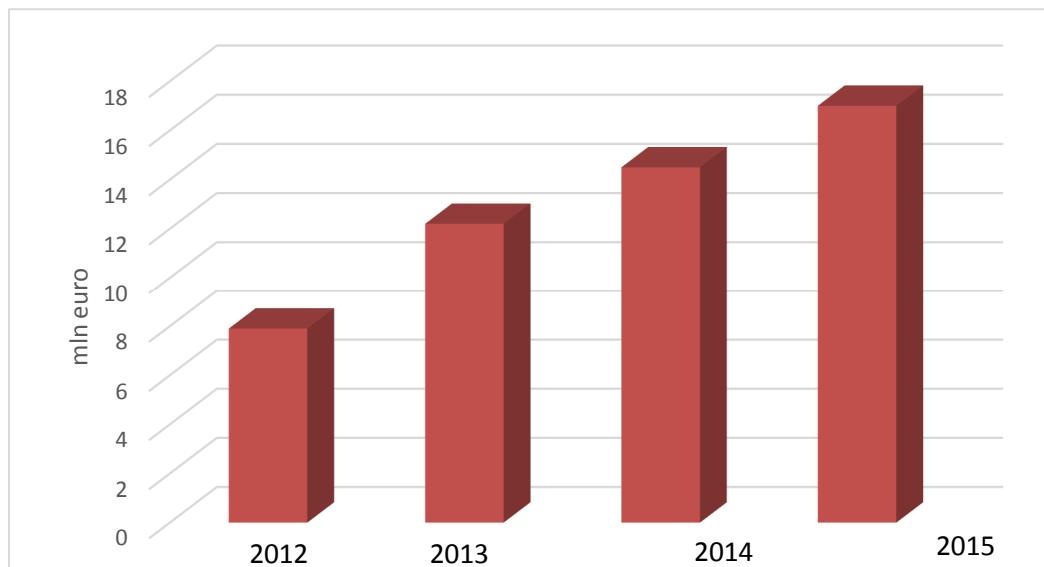

Figure 7. Consumer Market Capacity for Organic Goods, 2012-2015

Based on the data of Fig. 7, the capacity of the consumer market increased by 2.15 times in 2015 compared to 2012. Such data indicate a rather rapid development of organic production in Ukraine, however, comparing the consumption of organic products, for example in Germany and Ukraine, its capacity in Germany is 505 times higher than in Ukraine. For its more dynamic development it is necessary to support organic producers both on scientific (studying of foreign experience, development of new technologies, introduction in production of finished food products on the basis of organic raw materials), and on investment (search of foreign donors) and educational (promotion of healthy food, holding workshops in schools and higher education institutions) levels.

Along with the positive developments in the field of organic production of Ukraine, there are a number of unresolved problems, which, in particular, concern the export of organic products. To address them and develop specific proposals, we conducted a SWOT analysis of the export potential of Ukrainian organic producers (Table 1). Therefore, the results of the SWOT analysis revealed the weaknesses and strengths of the export potential of Ukrainian organic producers. We have identified four main strategies for strengthening and building it, namely:

- search for partners. Ukrainian producers need to constantly expand their partner base, explore foreign organic food markets and possible distribution channels, and the search for foreign investors who can invest in organic food production remains an important issue. In order to find distribution channels, it is important to master the tools of communication through the Internet network, to register the company on international trading organic platforms;

- information campaign for the society, which will promote organic products among Ukrainian consumers, because before entering the foreign markets, producers should be approved in the domestic;

- State support at the financial level. Since the transition to organic production is quite risky, costly and long-lasting, the state should encourage producers. Although there are already some developments in this area, the state needs to take advantage of the positive experiences of more developed countries. Thus, in Germany, the amount of state support is 170-750 euros / ha, Switzerland - 162-970, France - 80-900, the Netherlands - up to 650, Poland - 66.6-394.5, Lithuania - up to 376 euros / ha. The regions of Ukraine can also benefit from the positive experience of the Poltava region, where in October 2017 the Program of development and support of the agrarian complex of Poltava region by priority directions for the period up to 2020 was approved. carrying out and confirmation of conformity of production of organic products (raw materials) and obtaining a certificate of conformity in crop production, animal husbandry and processing of agricultural products, including derivatives period, regardless of the agricultural activities and types of food processing and compensation amounting to 20% of organic products delivered childcare, school, health and social institutions region in terms of public procurement;

- State support at the legislative level - according to the Ministry of Agrarian Policy, the adoption of the draft law "On Basic Principles and Requirements for Organic Production, Circulation and Labeling of Organic Products" (No. 5448) will open new markets for Ukrainian organic producers;

- increase of competitiveness, which consists in integrity and affirmation of a positive image of Ukrainian producers in the world market. An important step in this respect is the gradual transition of all organic exporters and certification bodies to the European Commission's TRACES electronic certification system intended for the issuance of an electronic export inspection certificate, which permits the export of organic products to the EU.

Table 1. SWOT analysis of export potential of Ukrainian organic producers

Internal factors / External factors	Opportunities (O) - expansion of the market of prepared foods based on organic raw materials; - implementation of the Association Agreement with the EU, in part annex XXVIII to ch. 17 "Agriculture and Rural Development" Chapter V "Economic and Sectoral Cooperation"	Threats (T) - low purchasing power of Ukrainians; - a strong competitive environment in developed countries; - falsification of organic products by unscrupulous producers
- Strengths (S) - expansion of safe food products; - reducing the negative impact on the environment; - involvement of investors in agricultural activities; - increasing jobs in rural areas; - increasing the share of healthy food consumers	S + O expectations: - search for European partners for the sale of Ukrainian organic products; - search for investors in the production of finished foods in Ukraine. Strategy: Partner Search	T + S expectations: - promotion of healthy eating; - increasing the share of consumers of organic products. Strategy: A public awareness campaign
Weaknesses of W - imperfection of the legislative framework; - low level of consumer knowledge about organic products; - the cost of transition to organic production; - the need for certification of organic production, which "scares" some producers; - storage losses can be higher due to the rejection of chemical additives	- a powerful system of state support for organic producers; - state social program for disseminating information on conscious consumption and healthy nutrition. Strategy: State support at the legislative and financial levels	- increasing confidence in Ukrainian producers abroad; - creation of a positive image of the Ukrainian producer of organic products at the world level. Strategy: Increasing competitiveness.

The signing of the Association Agreement with the EU expands the prospects of exporting organic products to the EU markets, since one of the areas of implementation of the Agreement is the expansion of trade in environmentally friendly goods and investment in environmentally friendly production.

Therefore, Ukraine is a country with a high export potential in the organic food market. Ukraine has already established itself as a potential exporter of agricultural raw materials, in particular cereals and oilseeds. As the capacity of the domestic consumer market for organic products in Ukraine is growing, but is still not at a high level, the search for foreign markets for organic organic producers is one of the priority areas. Currently Ukraine's largest partners in the organic market are EU countries (Germany, Poland, Switzerland, Austria). Other Western countries - Great Britain and Canada - are promising partners for Ukraine. However, in order to increase organic exports to the state and producers, efforts should be consolidated in four directions: state support for organic producers at the financial and legislative levels, search for partners (investors and potential buyers abroad), increasing the competitiveness of organic products and conducting information campaigns for society promoting healthy eating.

References

1. Mylovanov Y.V. (2009) Orhanichne sil's'ke gospodarstvo: perspektyvy dlya Ukrayiny, Handbook of the Ukrainian farmer, Institute of Plant Growing. V. Yuryev, Kharkiv, Ukraine
2. Pysarenko, V.V. (2008), Marketynh ovochevoi produktsii (metodychni ta praktychni aspekty) [Marketing of vegetable products (methodological and practical aspects)], FOP Hovorov S.V., Poltava, Ukraine.
3. Pysarenko V.M., Pysarenko P.V. (2017). Orhanichne zemlerobstvo dlya pryvatnoho sektora [Organic farming for the private sector]. Orhanichne zemlerobstvo dlya pryvatnoho sektora [Organic farming for the private sector]. Poltava: Public Association «Poltava Society of Agriculture», p.p. 132-138.
4. Tomashevskaya O. A. (2013). Orhanichne vyrobnytstvo v sviti realiyi ta perspektyvy. Ekonomika pryrodokorystuvannya ta ekolohizatsiya navkolyshnogo seredovyscha, 6, 161-164.
5. Artysh V.I. (2012). Osoblyvosti orhanichnoho ahrovyrobnytstva v kontseptsiyi staloho rozvytku APK Ukrayiny. Ekonomika APK, 7, 19-23.
6. Derii Zh., Koval, V., & Sedikova I. (2018). The role of the agricultural sphere in the context of food security. Scientific Bulletin of Polissia, 4(16), 21–27.
7. Galashevsky S.O. (2019). A practical guide organic exporter to the EU, Kyiv-Berlin, 57.

Olga Ostapenko*Candidate of Engineering Sciences, Ph.D, Associate Professor**Associate Professor of the Department of Heat Power Engineering**Vinnitsya National Technical University**Vinnitsya, Ukraine**orcid.org/ 0000-0001-9682-9419*

ESTIMATION OF EFFICIENCY OF ENERGY- AND RESOURCE-SAVING HEAT PUMP TECHNOLOGIES IN UKRAINE, IN THE CONCEPTS OF GREEN LOGISTICS AND SUSTAINABLE DEVELOPMENT

Abstract. *The investigation presents the approach, aimed at estimation of efficiency of energy- and resource-saving heat pump technologies in Ukraine, with taking into account the concept of green logistics and sustainable development. Our research aimed at analysis of energy sector of Ukraine and determination of energy advantages of application of heat pumps in the concepts of green logistics and sustainable development; estimation the perspectives of application of innovative heat pump technologies in the concepts of green logistics and sustainable development in Ukraine. The complex generalized dimensionless criterion of energy-ecological-economic efficiency of innovative technologies are substantiated, that aimed to perform the comprehensive assessment of efficiency of application of energy- and resource-saving, environmentally safe and cost-effective innovative heat pump technologies, in the concepts of green logistics and sustainable development. This approach enables to provide the substantiated determination of the perspectives of application of energy- and resource-saving, environmentally safe and cost-effective innovative heat pump technologies, in the concepts of green logistics and sustainable development, in order to increase the level of energy-economic efficiency of the energy sector of Ukraine.*

Introduction.

As it is noted in [37], the concept of Sustainable Development is determinates the 17 Sustainable Development Goals (SDGs) of development of humanity. The SDGs is defined the tendencies of development of sustainable energy and fuel and energy complex of Ukraine in the direction of European integration, ensuring reduction of greenhouse gas emissions and increasing the use of non-traditional and renewable energy sources with the application of energy- and resource-saving, environmentally safe and cost-effective innovative technologies.

According to [10, 11], Green logistics is a new scientific field, which provides for the use of advanced logistics technologies and modern equipment in order to minimize pollution and increase the efficiency of the use of logistics resources. The concept of sustainable development, according to [1 – 2, 4, 9 - 11], aims to maintain economic advancement and progress while protecting the long-term value of the environment. The concept of sustainable development implies the optimal use of limited resources and the use of environmentally friendly nature-, energy- and material-saving technologies at all stages of the life cycle with the production of environmentally acceptable products [5 – 7].

The basic principles of green logistics are given in [10, 37]:

- 1) rationalization of the use of natural resources and resources of the enterprise;
- 2) maximum utilization of production, packaging and packaging waste;
- 3) reducing the consumption of raw materials and materials with low recyclability or safe disposal;
- 4) application of modern high technology and recycling technologies;

5) increasing the level of environmental orientation and responsibility of logistics personnel.

These principles of green logistics allow to implement green technologies and help to rationalize the use of material flows of the enterprise. According to above mentioned, the tasks of green logistics are presented in investigations [10, 37]:

1) the use in the production of environmentally friendly and safe materials, as well as resource-saving technologies in order to minimize environmental pollution;

2) maximum utilization of industrial waste as secondary raw materials, materials and defective and defective goods;

3) optimization of waste disposal costs;

4) resource saving and energy saving in production;

5) increase of product competitiveness;

6) reducing the cost of production;

7) reducing the time for collection, differentiation and refining waste;

8) reduction of transport costs;

9) attraction of all production facilities, etc.

As it is noted in [10, 37], the above tasks of green logistics allow you to use the latest waste processing and recycling technologies, resource-saving technologies in production, and maximum recycling of production, packaging and packaging waste.

Sustainable development of society is possible only in the conditions of energy saving, that is, the development of systems that use energy more efficiently, provide the same or even higher level of transport services, lighting, heating, etc. with less energy consumption. The use of fossil fuels and nuclear energy is contrary to the principle of sustainable development, since these resources are non-renewable, and their use pollutes the environment. Moving towards a sustainable society requires a slow elimination of dependence on fossil fuels. Therefore, the way to overcome the current energy crisis is to switch to the use of alternative (non-traditional) energy sources, in particular, the introduction of heat pump installations. Advantages of application of heat pump installations for the conditions of Ukraine are determined and substantiated on the basis of the results of research, published in a number of national and foreign publications [12 – 40], as it is noted in [19].

1. Analysis of energy sector of Ukraine and determination of energy advantages of application of heat pumps in the concepts of green logistics and sustainable development

As it is noted in investigation [37], On August 18, 2017, the Government of Ukraine approved the Energy Strategy of Ukraine for the Period up to 2035 "Security, Energy Efficiency, Competitiveness". Ukraine's energy strategy will help ensure energy security and sustainable development of Ukraine's energy sector through 2035. The prerequisites for the development of a new Energy Strategy of Ukraine were: the need to ensure energy independence and energy security of Ukraine, changes in the energy policy of the European Union, the creation of an Energy Union in Europe and the signing by Ukraine of the Memorandum on the full integration of the energy markets of Ukraine and the EU, the signing of the Paris Agreement of Climate Change. Ukraine's energy strategy takes into account European achievements in the fields of energy production, energy efficiency improvement, aimed at ensuring the decarbonisation of the energy sector and reducing the amount of harmful emissions into the atmosphere. Ukraine's energy strategy will help to provide conditions for a gradual reduction in the use of traditional fossil fuels and increase the share of energy from non-traditional renewable sources.

An energy strategy should ensure energy independence and energy security of Ukraine on the basis of maximizing the use of its own energy resources. Ukraine's new energy model should provide equal opportunities for the development of all types of energy generation, with particular emphasis on improving energy efficiency and implementing innovative resource-saving technologies for the use of energy from renewable and alternative sources [37].

A number of investigations in recent years were devoted to the studying of efficiency of application of innovative resource-saving technologies in the world and Ukraine [1, 5 – 7, 11, 12, 19, 37].

The paper [37] considers the prospects for the application of innovative resource-saving technologies in the concepts of green logistics and sustainable development. Assessment of the perspectives of application of innovative resource-saving technologies in Ukraine was carried out with taking into consideration the main goals of sustainable development, tendencies of development of sustainable energy and fuel and energy complex of Ukraine in the direction of European integration, ensuring reduction of greenhouse gas emissions and increasing the use of non-traditional and renewable energy sources. The study illustrates the application of principles and objectives of the concept of green logistics in order to increase the level of energy-economic efficiency of the energy sector of Ukraine with the application of energy- and resource-saving, environmentally safe and cost-effective innovative technologies.

Our research [37] is based on the "Tracking SDG7" - resource, which uses the databases of the International Renewable Energy Agency (IRENA), the International Energy Agency (IEA), the World Bank, the United Nations Statistics Division (UNSD) and others ("Tracking SDG7", "Rise", "Esmap"). We also used statistics from Eurostat and World Bank resources ("Eurostat", "DataBank. WorldBank").

As it is noted in [37], the 20-20-20 goal package includes the following goals for 2020:

- a reduction in EU greenhouse gas emissions of at least 20% below 1990 levels;
- ensuring gross final energy consumption in the EU is at least 20% of renewable energy;
- ensure a 20% reduction in primary energy consumption by improving energy efficiency.

In Fig. 1 (from the investigation [37]) shows a comparison of gross inland energy consumption by fuel (in%) for 28 EU countries, 19 Euro area countries and Ukraine.

From fig. 1 [37] shows that in Ukraine, the percentage of usage of renewable energy and biofuels is 3...4 times lower than in the EU and the Euro area. This indicates the need to increase the share of non-traditional and renewable energy sources in the fuel and energy sector and in the energy sector of Ukraine.

The International Energy Agency (IEA) has prepared an analytical work "Forecast of world energy development for the future until 2035 (IEA-2012)", according to which in 2010-2035 the level of world energy consumption will increase by 35%, the smallest increase in energy consumption will be for coal (13%), the largest increase in energy consumption - for renewable energy sources (87%) [3].

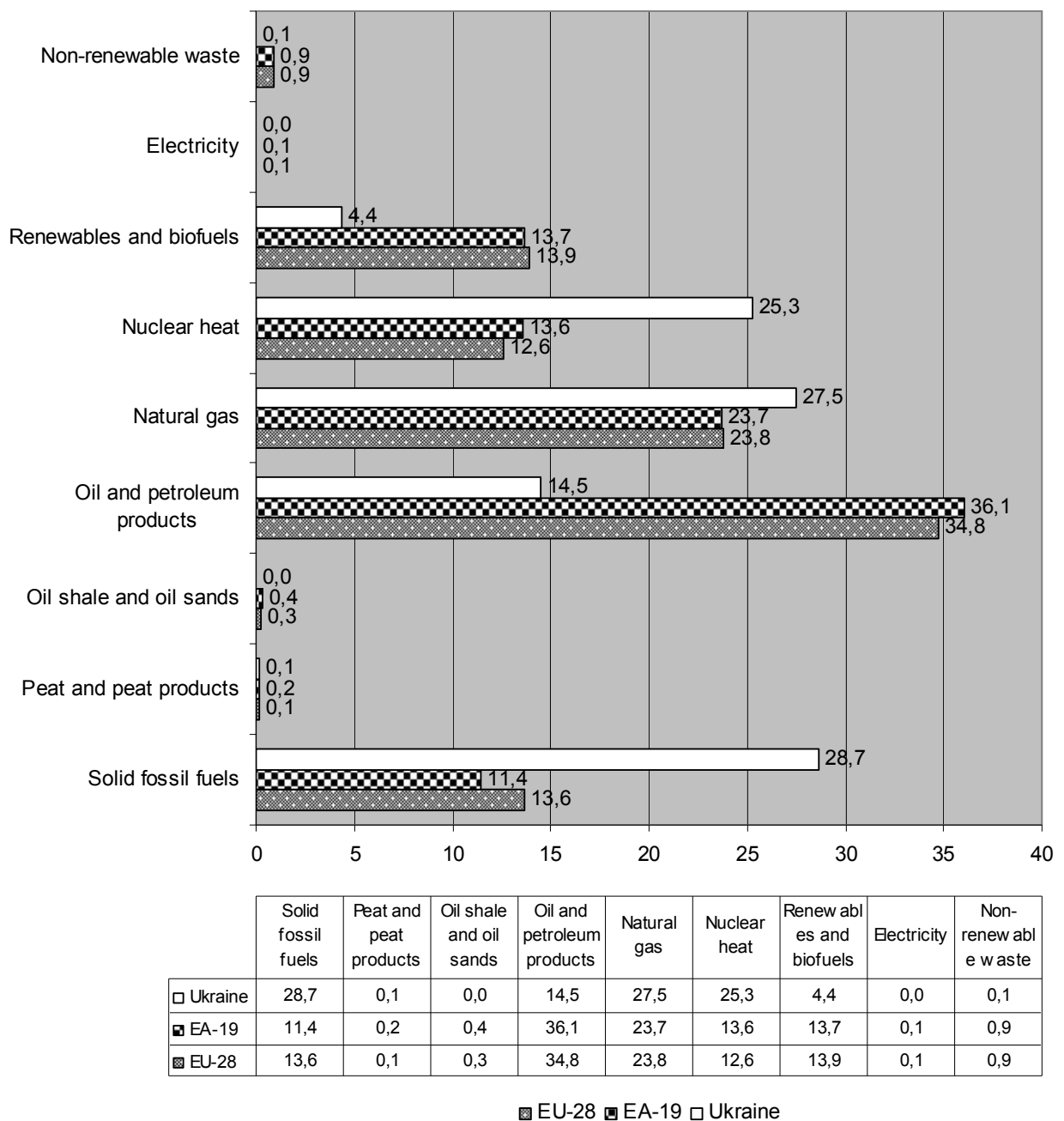

Fig. 1. Comparison of gross inland energy consumption by fuel (in%) for 28 EU countries, 19 Euro area countries and Ukraine

Source: authors research results from [37]

Based on the publication [8], the structure of electricity production in the United Energy System of Ukraine in 2019 from power plants of different types is determined; the results are shown in Table 1.

In Table 1 are indicated: TPP - thermal power plants, CHP (combined heat and power) - power plants, using a heat engine to generate electricity and useful heat simultaneously, HPP – hydro power plants, HAPP - hydro accumulating power plants, NPP - nuclear power plants, WEP - wind energy plants, SPP - solar power plants of thermodynamic cycle.

Table 1. Structure of electricity production in the United Energy System of Ukraine in 2019 from power plants of different types

Electricity generation	2019	
	Million kW-hours	%
Electricity generation - total	153964,80	100
including:		
TPP and CHP, of them:	55781,45	36,23
TPP of Generating Companies	44926,93	29,18
CHP and cogeneration units	10854,52	7,05
HPP and HAPP, of them:	7867,60	5,11
HPP	6528,11	4,24
HAPP	1339,49	0,87
NPP	83002,42	53,91
Alternative sources (WEP, SPP, biomass)	5542,73	3,60
Block-plants and other sources	1770,60	1,15

Source: [8]

It should be noted, that the long-term forecast of the IEA and other international organizations takes into account the annual decline in energy intensity of gross domestic product by increasing energy efficiency in all sectors of the economy, especially more energy-intensive - in industry and energetics [3]. The component values of 1 MWh of electricity sold in the wholesale electricity market in 2019 are shown in Table 2.

Table 2. The component values of 1 MWh of electricity sold in the wholesale electricity market in 2019

Source of electricity and primary energy sources	Component values of 1 MWh of electricity sold in the wholesale electricity market, UAH / MWh	Share of the cost of electricity sold in the wholesale electricity market in the wholesale price of electricity, %
NPP	323,28	25,6
TPP of Generating Companies	534,31	42,32
HPP except small ones	43,98	3,48
HPP small	7,57	0,60
WEP	37,13	2,94
Solar energy	50,90	4,03
Biomass and biogas	8,22	0,65
CHP and other	178,78	14,17
Other components of the wholesale price of electricity	78,45	6,21
Wholesale price of electricity	1262,61	100,00
Sales of electricity to the wholesale electricity market by producers	1184,16	93,79

Source: [8]

Electric energy in Ukraine is generation by different types of power plants, as it is seen from Table 1. Knowing the values of efficiency factors of power plants and the shares of electric energy, generated by these stations, we can determine the average efficiency factor of electric energy generation in Ukraine.

Averaged value of the efficiency factor of electric power plants will be [34]:

$$\eta_{EPP} = \frac{\sum \alpha_i}{\sum (\alpha_i / \eta_i)}, \quad (1)$$

where α_i – shares of electric energy, generated by corresponding electric power stations; η_i – efficiency factor of the corresponding electric power station.

Taking into account the values of shares of electric energy, generated by corresponding electric power stations (from Table 1) and the values of efficiency factor of the corresponding electric power station from investigation [34] and others, we may obtain from the formula (1) the averaged value of efficiency factor of power plants in Ukraine.

From electric power plants the electric energy across distributive grids arrives to the consumers. Efficiency factor η_{DG} of distributive electric grids operation is determined by the level of energy losses in the process of its transportation [34], which may be determined according to the annual report of National Commission of Energy Branch Regulation of Ukraine, using the value of total technological losses of electric energy in grid of Ukraine.

At the end of energy chain there is a consumer of electric energy (for example, electric motor). Efficiency factor of 55–100 kW electric motors, taking into account losses of energy in motor control unit, will be $\eta_{ED} = 80\text{--}85\%$. Efficiency factor of large power electric motor will be $\eta_{ED} = 90\text{--}95\%$ [34].

Thus, having analyzed chain of generation, transportation and conversion of electric energy, we will obtain the value of general efficiency factor of generation, transportation and conversion of electric energy to the consumer of electric energy with electric drive [34]

$$\eta_{EP} = \eta_{EPP} \cdot \eta_{DG} \cdot \eta_{ED}. \quad (2)$$

Cogeneration drive for electric energy consumers has advantages as compared with electric one, because it enables to avoid additional losses of electric energy during transportation. Besides, application of cogeneration drive from gas-piston engines for electric energy consumers can be considered as one of important directions of energy and resources-saving, as it provides utilization of fuel gases heat after gas engine, that provides better energy efficiency. For cogeneration drive for electric energy consumers the general efficiency factor of generation, transportation and conversion of electric energy will be determined by the formula: $\eta_{EP} = \eta_{EM} \cdot \eta_{ED}$, where η_{EM} – efficient factor of gas-piston engine.

Efficient integration of steam compressor heat pump (HP) with electric and cogeneration drives in industry and energy sector is substantiated by the need to provide the economy of equivalent fuel as a result of introduction [34].

Economy of equivalent fuel (in per cent) as a result of usage of steam compressor HP with electric and cogeneration drives is determined in the following way:

$$\Delta B_e = \left(1 - \frac{\eta_{s.h.}^n}{\varphi_r \cdot \eta_{EP}} \right) \cdot 100, \quad (3)$$

where $\eta_{s.h.}^n$ – netto-efficiency factor of substituted source of the heat, φ_r – real coefficient of performance of steam compressor HP from the investigation [34], η_{EP} – general efficiency factor of generation, transportation and conversion of electric energy from formula (2).

In home, foreign literature and in practice the efficiency of HP usage is estimated mainly according to real coefficient of performance. For efficient operation of HP with electric drive value of $\varphi_r \geq 2,5 \dots 3,0$ is considered to be acceptable; high energy efficiency of HP is provided at $\varphi_r = 3,5 \dots 4,0$. Such values of coefficients of performance are proved by statistic data of real coefficients of performance of HP, manufactured by such companies as LG, Mitsubishi, MHPUL, MHPUE, FUJITSU, McQUAY, HPVU, "ENERGY", "TRITON-LTD" [34].

High energy efficiency of HP with cogeneration drive is provided if $\varphi_r \geq 2,0$; it is stipulated by the fact, that additional heat power of utilization equipment of HP cogeneration drive is taken into account [34].

According to [34], efficient introduction of steam compressor HP with electric and cogeneration drives in industry and energy sector will be achieved on condition:

$$\varphi_r > \frac{\eta_{s.h.}^n}{\eta_{EP}} \quad (4)$$

Study of HP energy efficiency was performed, applying the method of mathematical modeling of HP operation. Energy efficiency of HP with electric drive and cogeneration drive of the compressor from gas-piston engine (GPE) was investigated in [34]. The schemes of the above-mentioned HP are given in [26].

The study [34] contains the evaluation of equivalent fuel economy as a result of introduction of steam compressor HP of small (up to 1 MW), average and large powers with electric and cogeneration drive (from GPE). Study was performed for the cases of usage in electrically-driven HP electric energy from various types of electric power stations (of alternative types of electric power plants on the base of steam-gas installations (SGI) and gas-turbine installations (GTI), solar power plants of thermodynamic cycle (SPP), wind energy plants (WEP)), and also for averaged values of efficiency factors of electric power stations in Ukraine. The study takes into consideration that netto-efficiency factor of substituted source of the heat is $\eta_{s.h.}^n = 0,8$.

By the results of study [34], it has been determined, that sufficient energy efficiency of HP with electric drive for various sources of drive energy of steam compressor HP and with the account of energy losses for generation, transportation and conversion of electric energy is provided at $\varphi_r \geq 2,5$. High energy efficiency of HP with electric drive for various sources of drive energy of steam compressor HP and with the account of energy losses for generation, transportation and conversion of electric energy is provided at $\varphi_r \geq 3,5$. It has been determined, that high energy efficiency of HP with cogeneration drive with the account energy losses for generation, transportation and conversion of electric energy to HP is provided at $\varphi_r \geq 2,0$. These values of the coefficient of performance well agree with statistical data regarding the real coefficient of performance of HP, manufactured by companies LG, Mitsubishi, MHPUL, MHPUE, FUJITSU, McQUAY, HPVU, "ENERGY", "TRITON-LTD".

The presented in [34] results of research allow to evaluate equivalent fuel economy as a result of usage of steam compressor HP with electric and cogeneration drives for various operation modes of HP and allow to perform the choice of efficient operation modes of steam compressor HP, taking into account of the impact of drive energy sources of steam compressor heat pumps and energy losses for generation, transportation and conversion of electric energy.

2 Perspectives of application of innovative heat pump technologies in the concepts of green logistics and sustainable development

In our study [37] we suggested to perform the comprehensive assessment of efficiency of application of energy- and resource-saving, environmentally safe and cost-effective innovative technologies, in the concepts of green logistics and sustainable development, with application complex generalized dimensionless criterion of energy-ecological-economic efficiency of innovative technologies:

$$K_{INN}^{compl.} = \beta \cdot K_{RES} + \Delta E + \Delta EC + K_{REC}, \quad (5)$$

where β – share of replacement the traditional technology by innovative technology;

K_{RES} – dimensionless criterion of relative energy- and resource-saving efficiency of innovative technology, which used for the determination of energy- and resource-saving operation modes, this criterion may be applied on condition that $K_{RES} > 0$; ΔE – is relative economic efficiency of innovative technology, which used for the determination of economically valid operation modes on condition that $\Delta E > 0$; ΔEC – is relative ecologic efficiency of innovative technology, that enables to determine ecologically safe operation modes of innovative technology on condition that $\Delta EC > 0$; K_{REC} – dimensionless criterion of relative recycling (and/or utilization of the waste) efficiency of innovative technology, which used for the determination of recycling or waste utilization possibilities of innovative technology; this criterion may be applied on condition that $K_{REC} > 0$ [37].

In the research [37] the justification of the application of the methods of green logistics and sustainable development for the analysis of perspectives of application of innovative technologies is presented. According to such approach, in our research is determined that: energy- and resource-saving, economically substantiated, ecologically safe and recycling (and/or utilization of the waste) efficient innovative heat pump technologies will be provided on conditions of: $K_{INN}^{compl.} > 0$ and $K_{RES} > 0$ and $\Delta E > 0$ and $\Delta EC > 0$ and $K_{REC} > 0$. The greater is the value of $K_{INN}^{compl.}$ index, the more energy efficient, ecologically safe, economically efficient and competitive innovative heat pump technology will be. Application of the suggested in [37] approaches, aimed at determination of the areas of efficiency of application of energy- and resource-saving, environmentally safe and cost-effective innovative technologies will be demonstrated on the specific example of HP. Fig. 2 (from the investigation [37]) shows the results of comprehensive assessment of efficiency of application of energy- and resource-saving, environmentally safe and cost-effective innovative technology - cogeneration heat pump technology, in the concepts of green logistics and sustainable development. In our research [37] the values of complex generalized dimensionless criterion of energy-ecological-economic efficiency of innovative heat pump technologies are determined on conditions of replacement share the traditional technology by innovative technology, which change in the range of $\beta = 0,125 \dots 1,0$.

Fig. 2 (from the investigation [37]) shows the area of efficiency of application of energy- and resource-saving, environmentally safe and cost-effective innovative cogeneration heat pump technology, using the heat of water recycling system with cogeneration heat pump installation (CHPI) of small power. This area is determined by the complex generalized dimensionless criterion of energy-ecological-economic efficiency of innovative technologies from the formula (5).

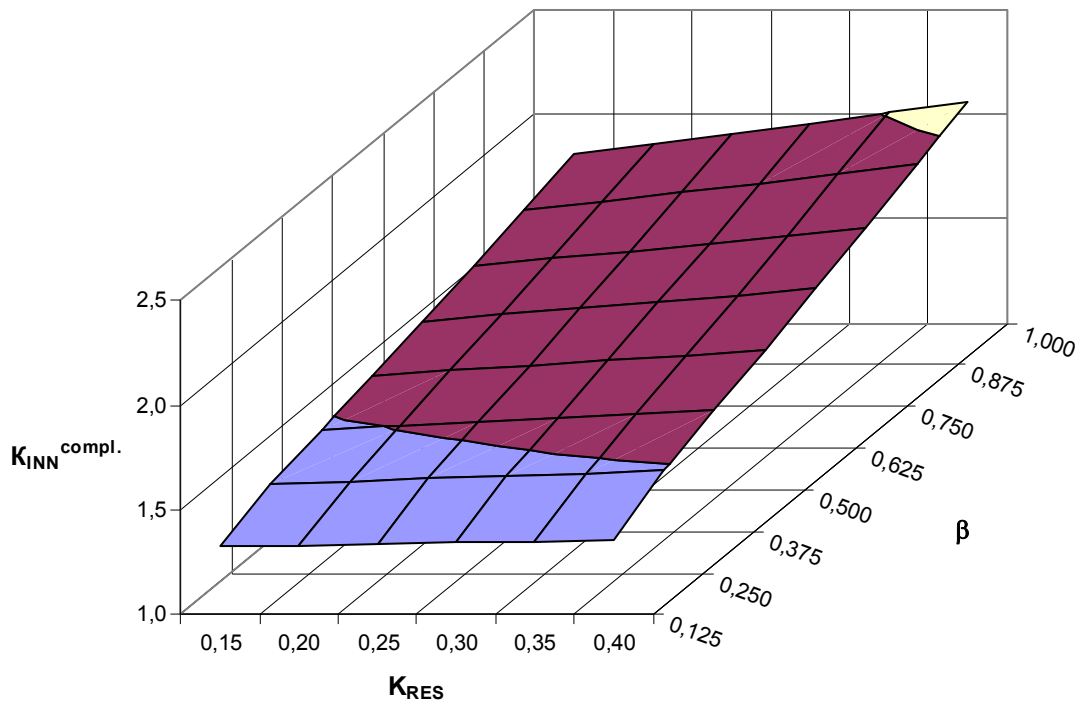

Fig. 2. Area of efficiency of application of innovative cogeneration heat pump technology of small power, using the heat of water recycling system

Source: authors research results from [37]

As it is seen from Fig. 2, on conditions of $K_{INN}^{compl.} > 0$ and $K_{RES} > 0$ and $\Delta E > 0$ and $\Delta EC > 0$ and $K_{REC} > 0$, dependence, shown in Fig. 2, determine areas of efficiency of application of energy- and resource-saving, environmentally safe and cost-effective innovative cogeneration heat pump technology, using the heat of water recycling system. On such conditions, the above-mentioned innovative heat pump technology can be recommended as energy- and resource-saving, environmentally safe and cost-effective innovative technology.

Conclusions.

The investigation presents the approach, aimed at estimation of efficiency of energy- and resource-saving heat pump technologies in Ukraine, with taking into account the concept of green logistics and sustainable development.

Our research aimed at analysis of energy sector of Ukraine and determination of energy advantages of application of heat pumps in the concepts of green logistics and sustainable development; estimation the perspectives of application of innovative heat pump technologies in the concepts of green logistics and sustainable development in Ukraine.

The complex generalized dimensionless criterion of energy-ecological-economic efficiency of innovative technologies are substantiated, that aimed to perform the comprehensive assessment

of efficiency of application of energy- and resource-saving, environmentally safe and cost-effective innovative heat pump technologies, in the concepts of green logistics and sustainable development. This approach enables to provide the substantiated determination of the perspectives of application of energy- and resource-saving, environmentally safe and cost-effective innovative heat pump technologies, in the concepts of green logistics and sustainable development, in order to increase the level of energy-economic efficiency of the energy sector of Ukraine.

The application of the methods of green logistics, sustainable development and sustainable energy in order to increase the level of energy-economic efficiency of the energy sector of Ukraine with using of heat pumps is presented in given paper.

The justification of the application of the methods of green logistics and sustainable development for the analysis of perspectives of application of innovative technologies is presented in the research [37]. According to such approach, in our research is determined that: energy- and resource-saving, economically substantiated, ecologically safe and recycling (and/or utilization of the waste) efficient innovative heat pump technologies will be provided on conditions of:

$K_{INN}^{compl.} > 0$ and $K_{RES} > 0$ and $\Delta E > 0$ and $\Delta EC > 0$ and $K_{REC} > 0$. The greater is the value of $K_{INN}^{compl.}$ index, the more energy efficient, ecologically safe, economically efficient and competitive innovative heat pump technology will be. On such conditions, the above-mentioned innovative heat pump technology can be recommended as energy- and resource-saving, environmentally safe and cost-effective innovative technology.

The suggested in [12 – 25, 27 – 32, 37] methodical fundamentals allow to determine the areas of efficient application of energy- and resource-saving, environmentally safe and cost-effective innovative cogeneration heat pump technology and develop recommendations of high efficient operation of innovative cogeneration heat pump technology. For practical application of the suggested in studies [12 – 25, 27 – 32, 37] methodical fundamentals for comprehensive assessment of efficient application of energy- and resource-saving, environmentally safe and cost-effective innovative heat pump technologies, in the concepts of green logistics and sustainable development, we propose to use the results, obtained in the research [12, 14, 19, 25, 31, 33 - 39].

References

1. Brych, V. Yar., & Fedirko, M. M. (2018). Concept of Energy Efficiency in the Context of Sustainable Development of Ukraine's Municipal Heat Engineering. *Ukrainian Journal of Applied Economics*, Vol. 3, 1. Retrieved from: <http://ujae.tneu.edu.ua/index.php/ujae/article/view/214/212>. [in Ukrainian]
2. Emas, R. (2015). The Concept of Sustainable Development: Definition and Defining Principles. *Brief for GSDR 2015*. Retrieved from: <https://sustainable-development.un.org>.
3. Foreign experience in improving energy efficiency and introducing new technologies for electricity generation. Retrieved from: https://ua.energy/wp-content/uploads/2018/01/4.-Efektyvn_vyrobn_elektroenergiyi.pdf. [in Ukrainian]
4. Klarin, T. (2018). The Concept of Sustainable Development: From its Beginning to the Contemporary Issues, *Zagreb International Review of Economics and Business*, Vol. 21, 1, 67 – 94. DOI: 10.2478/zireb-2018-0005.
5. Koval, V., Duginets, G., Plekhanova, O., Antonov, A., & Petrova, M. (2019). On the supranational and national level of global value chain management. *Entrepreneurship and Sustainability Issues*, 6(4), 1922-1937. [http://doi.org/10.9770/jesi.2019.6.4\(27\)](http://doi.org/10.9770/jesi.2019.6.4(27)).

6. Koval, V., Slobodianiuk, O., & Yankovyi, V. (2018). Production forecasting and evaluation of investments using Allen two-factor production function. *Baltic Journal of Economic Studies*, 4(1), 219–226. doi:10.30525/2256-0742/2018-4-1-219-226.
7. Koval, V., Prymush, Y., & Popova, V. (2017). The influence of the enterprise life cycle on the efficiency of investment. *Baltic Journal of Economic Studies*, 3(5), 183–187. doi:10.30525/2256-0742/2017-3-5-183-187.
8. Main indicators of the fuel and energy complex of Ukraine for 2019. Retrieved from: http://mpe.kmu.gov.ua/minugol/control/uk/publish/article?art_id=245436840&cat_id=35081. [in Ukrainian]
9. Mandryk O, Arkhypova L, Pukish A, Zelmanovych A & Yakovlyuk Kh. (2017). Theoretical and methodological foundations of sustainable development of Geosystems. IOP Conf. Series: Materials Science and Engineering, 200 012018. DOI: 10.1088/1757-899X/200/1/012018
10. Melnikova, N; Yanchenko, N. (2018). The analysis of the interpretation and the essence of green logistics. *Social Economy*, Vol. 56, pp. 183–189.
11. Omel'chenko, I. N., Aleksandrova, A. A., Brom, A. Ye., Belova, O. V. (2013). Osnovnyye napravleniya razvitiya logistiki XXI veka: resursosberezheniye, energetika i ekologiya. *Gumanitarnyy vestnik*, 10. Retrieved from: <http://hmbul.ru/articles/118/118.pdf>. [in Russian]
12. Ostapenko, O. P. (2019). *Analysis of energy, ecological and economic efficiency of steam compressor heat pump installations, as compared with alternative sources of heat supply, with accounting the concept of sustainable development*. Sustainable Development Under the Conditions of European Integration. Part II, (pp. 312 – 329). Ljubljana:Visoka šola za poslovne vede.
13. Ostapenko, O. P. (2018). Application of the method of complex assessment of energy-ecological-economic efficiency of energy supply systems with cogeneration heat pump installations and peak sources of heat. *Science and Education a New Dimension. Natural and Technical Sciences*, 171, 51 – 54. DOI: 10.31174/SEND-NT2018-171VI19-11.
14. Ostapenko, O. P. (2019). Application of the methods of green logistics and sustainable development for the synthesis of highly efficient systems of energy supply with heat pumps. *Knowledge management, economics and Law: proceedings of the 1st International Scientific conference* (pp. 42 – 44). – Batumi: Publishing House «Kalmosani».
15. Ostapenko, O. P. (2017). Areas of high energy efficiency of energy supply systems with cogeneration heat pump installations of large power and peak fuel-fired boilers for heat supply systems. *Science and Education a New Dimension. Natural and Technical Sciences*, 132, 70-74.
16. Ostapenko, O. P. (2017). Areas of high energy efficiency of energy supply systems with cogeneration heat pump installations of small power and peak electric boilers in heat supply systems. *Science and Education a New Dimension. Natural and Technical Sciences*, 121, 77-80.
17. Ostapenko, O. P. (2017). Areas of high energy efficiency of energy supply systems with cogeneration heat pump installations of small power and peak fuel-fired boilers. *Science and Education a New Dimension. Natural and Technical Sciences*, 140, 64-68.
18. Ostapenko, O. P. (2017). Areas of high energy efficiency of energy supply systems with cogeneration heat pump installations of small power and peak electric boilers. *Science and Education a New Dimension. Natural and Technical Sciences*, 148, 85-89.
19. Ostapenko, O. P. (2020). *Estimation of energy-ecological-economic efficiency of energy supply systems with cogeneration heat pump installations in Ukraine, in the concepts of green*

logistics and sustainable development. Institutional Development Mechanism Of The Financial System Of The National Economy: (pp. 52 – 66). Batumi: Publishing House “Kalmosani”.

20. Ostapenko, O. P. (2016). Energy efficiency of energy supply systems, based on combined cogeneration heat pump installations and peak sources of heat. *Scientific Works of Vinnytsia National Technical University*, 1. Retrieved from: <http://works.vntu.edu.ua/index.php/works/article/view/462/464>.

21. Ostapenko, O. P. (2016). Energy efficiency of energy supply systems with cogeneration heat pump installations and peak sources of heat in heat supply systems. *Scientific Works of Vinnytsia National Technical University*, 2. Retrieved from: <https://works.vntu.edu.ua/index.php/works/article/view/472/474>.

22. Ostapenko, O. P. (2017). Methodical fundamentals of energy economical efficiency assessment of energy supply systems with cogeneration heat pump installations and peak sources of heat. *Scientific Works of Odesa National Academy of Food Technologies*, 81, 136 – 141. [in Ukrainian]

23. Ostapenko, O. P. (2015). Methodical fundamentals of complex assessment of energy efficiency of steam compressor heat pump plants with electric and cogeneration drive. *Scientific Works of Odesa National Academy of Food Technologies*, 47, 157 – 162. [in Ukrainian]

24. Ostapenko, O. P. (2017). Methodical fundamentals of complex assessment of energy-ecological-economic efficiency of energy supply systems with cogeneration heat pump installations and peak sources of heat. *Scientific Works of Vinnytsia National Technical University*, 3. Retrieved from: <https://works.vntu.edu.ua/index.php/works/article/view/510/509>.

25. Ostapenko, O. P. (2018). Principles for selection of the areas of energy-ecological-economic efficiency of energy supply systems with cogeneration heat pump installations and peak sources of heat. *Applied Scientific and Technical Research –2018: proceedings of the Second International Scientific and Practical conference* (p. 69). – Ivano-Frankivsk: Forte Symphony.

26. Ostapenko, O. P. (2015). *Refrigeration equipment and technology. Heat pumps*. Vinnytsia: VNTU. [in Ukrainian]

27. Ostapenko, O. P. (2016). *Scientific basis of evaluation energy efficiency of heat pump plants*. Saarbrücken: LAP LAMBERT Academic Publishing.

28. Ostapenko, O. P. (2016). Spheres of energy efficient operation of energy supply systems with cogeneration-heat pump installations and peak sources of heat. *Scientific Works of Vinnytsia National Technical University*, 3. Retrieved from: <https://works.vntu.edu.ua/index.php/works/article/view/479/481>.

29. Ostapenko, O. P. (2016). Spheres of high energy efficiency of energy supply systems with cogeneration heat pump installations of large power and peak fuel-fired boilers. *Science and Education a New Dimension. Natural and Technical Sciences*, 110, 64-67.

30. Ostapenko, O. P. (2017). Spheres of high energy efficiency of energy supply systems with cogeneration-heat pump installations of small power and fuel-fired boilers in heat supply systems. *Scientific Works of Vinnytsia National Technical University*, 1. Retrieved from: <https://works.vntu.edu.ua/index.php/works/article/view/497/499>.

31. Ostapenko, O. P. (2019). *Study of energy-economic efficiency of energy supply systems with cogeneration heat pump installations, using the heat of the industrial and natural sources, in industry and municipal heat power branch of Ukraine*. Social and Legal Aspects of the

Development of Civil Society Institutions Part I, (pp. 292 – 308). Warsaw: Institute of European Integration, Bmt Eridia.

32. Ostapenko, O. P. (2018). Substantiation of the method of complex assessment of energy-ecological-economic efficiency of energy supply systems with cogeneration heat pump installations and peak sources of heat. *Scientific Works of Vinnytsia National Technical University*, 1. Retrieved from: <https://works.vntu.edu.ua/index.php/works/article/view/526/524>.

33. Ostapenko, O. P., Bakum, Y. V., & Yuschishina, A. V. (2013). Energy, ecology and economy aspects of the efficiency of heat power stations operating on natural and industrial heat sources. *Scientific Works of Vinnytsia National Technical University*, 3. Retrieved from: <https://works.vntu.edu.ua/index.php/works/article/view/384/382>.

34. Ostapenko, O. P., Leshchenko, V. V., & Tikhonenko, R. O. (2015). Energy efficiency of energy supply systems, based on combined cogeneration heat pump installations. *Scientific Works of Vinnytsia National Technical University*, 4. Retrieved from: <http://works.vntu.edu.ua/index.php/works/article/view/451/453>.

35. Ostapenko, O. P., & Portnov, V. M. (2018). Analysis of energy-economic efficiency of energy supply systems with cogeneration heat pump installations in industry and municipal heat power branch of Ukraine. *Imperatives of Civil Society Development in Promoting National Competitiveness: proceedings of the 1st International Scientific and Practical conference* (volume I, pp. 111 – 113). – Batumi: Publishing House «Kalmosani».

36. Ostapenko, O. P., & Portnov, V. M. (2018). Economical aspects of the efficiency of usage of energy supply systems with cogeneration heat pump installations of various power levels. *Eastern European Studies: Economics, Education and Law: proceedings of the International Scientific conference* (volume II, pp. 60 – 62). – Burgas: Publishing House FLAT Ltd-Burgas.

37. Ostapenko, O., Savina, N., Mamatova, L., Zienina-Bilichenko, A. & Selezneva, O. (2020). Perspectives of application of innovative resource-saving technologies in the concepts of green logistics and sustainable development. Turismo: Estudos & Práticas (UERN), Mossoró/RN, Caderno Suplementar, 02. Retrieved from: <http://natal.uern.br/periodicos/index.php/RTEP/article/view/1261/1202>.

38. Ostapenko, O. P. & Shevchenko, O. V. (2011). Perspektyvy zastosuvannya teplonasosnykh stantsiy v Ukraini. *Suchasni tekhnolohiyi, materialy i konstruktsiyi v budivnytstvi: nauково-tekhnichnyy zbirnyk*, 2, 132-139. Vinnytsia: VNTU. [in Ukrainian]

39. Ostapenko, O. P., Valigura, I. O., & Kovalenko, A. D. (2013). Energy ecological efficiency of heat pumping stations, operating on natural and industrial sources of heat at variable operation modes. *Scientific Works of Vinnytsia National Technical University*, 2. Retrieved from: <https://works.vntu.edu.ua/index.php/works/article/view/376/374>.

40. Kostetska, K., Khumarova, N., Umanska, Y., Shmygol, N., & Koval, V. (2020). Institutional qualities of inclusive environmental management in sustainable economic development. *Management Systems in Production Engineering*, 28 (2), 15-22. <https://doi.org/10.2478/mspe-2020-0003>

41. Sustainable energy for all. Retrieved from: <https://www.seforall.org>.

Olena Zayats

*PhD in Economics, Assistant Professor,
Uzhorod National University,
88000, Uzhorod, Ukraine,
orcid.org/0000-0001-9904-8706*

**THE TRANSFORMATION OF INSTITUTIONAL MECHANISMS OF REGIONAL
TRADE-COMPETITIVE AGREEMENTS REGULATION**

***Abstract.** The study determines the substance and structure of the new system of the multi-level governance. The monitoring of regional trade agreements as institutions was undertaken. The development of the regional integration regulation within the global institutional architecture is considered. The peculiarities of the new stage of regionalism were identified. It is proved that competition between regional trade agreements and multilateral trade system has a complementary nature in the trade liberalization and integration initiatives as a result of synergy between regional and multilateral negotiating processes. Emphasizing that the mechanism for resolving issues of normative nature needs the subsequent development, particularly, through intensification of the negotiation process under the auspices of the WTO. And also identified that regional institutions and agreements can transform into an important element in the structure of the modern global management, since they are able to adapt global agreements in accordance to the regional specifics, in this way providing their effective realization.*

1. Introduction.

As for present day developments, international economic activity, as general, is accomplished not only within the national borders of the separate states. Inability of a state to create and support an active economy and to be included into a global business means that it stays economically weak, doesn't have the ability to develop dynamically, to compete at the international markets, can not ensure the economic growth and an adequate prosperity of its population. The intertwining of the international background, invariably build up into the structures, whereby the more apparent role belongs to the regional economic integration processes which in a number of cases have a decisive influence on the prospect of a global economic development. The increasing importance and economic potential of the states encourage countries realization of collaboration necessity for extension of the spectrum of actions and perspectives in economic, political, cultural, military, scientific and other spheres. In some regions the realization of the integration projects is assigned to supranational organizations, which activity can contradict with economy globalization tendency, especially it is associated with significant public orders creation, if they claim to be self-relevant in the international legal system.

As a result, the world economy globalization is also evident in the formation of a general business and informative worldwide range on a global scale. The creation of integration areas is one of the main tendencies near one or a group of the most developed countries and the areas which are fulfilled into different international legal forms and what is also determined by different grades of integrative processes in precise world regions. Another, but not least, the development tendency of the last centuries is the liberalization of international trade, which beside protectionism becomes an instrument for international trade regulation and it is also used for foreign economic policies implementation [1].

Progressively appears the understanding that the world economic and international economic relations are not up to function consistently without joint institutional mechanisms of coordination and control for all market stakeholders.

2. Results

2.1. System of the multilevel control. The enhancing of the integration relations between countries is happening for the simultaneous importance elevation of the supra-national institutions in the regulation of international economic relations sphere (both on regional and global levels) and activities of regional integrative alliances that develops into the powerful entities of the world economy. Conversely, aggravation of the international competition promotes activation of the regional integration relations between countries that are situated in different territorial regions of the world economy. It implies that institutional development of the inter-regional cooperation creates the new system of the multilevel control as a defined set of tools, formal and informal norms, procedures [2, c. 172–177].

At a micro-level, the companies began more actively create the vertical control schemes and gradually degenerate into transnational corporations. During the last decade at a macro-level came into being the whole system of economic and financial intergovernmental organizations with observers mandates for the world economic development, came out imbalance in order to provide the comprehensive support for countries in the case of necessity in the regional economic integration sphere. In due course it was Dj. M. Keynes who became one of the ideologists and authors of the agreement articles (statute) of so-called Bretton Woods Agreements [3], originating in the late wartime IMF and the World Bank, which up to now are the key international economic organizations.

The final act of Bretton Woods conference were recommendations to the states with the purpose of international trade and economic relations adjusting with reference to creation of International Trade Organization (through Havana statute creation (Havana conference) and creation of General Agreement on Tariffs and Trade (GATT) (London and Geneva conferences) [4].

For almost half-century history, as of the effective date of the General agreement nine such rounds were undertaken, most of them involved tariffs reduction, but the process of revision, reinterpretation or expansion of the articles of the Agreement began on the final rounds.

The WTO creation actually became the most world trade reform since the end of Second World War, implementing in a more up-to-date the attempt of International trade organization creation in 1948. This concluded GATT's the basic complex of universal agreements implementation and makes it possible to assert about new global law and order establishment in three main spheres of the commercial operations as goods, services, intellectual property.

For 2019 in the GATT/WTO 480 regional trade and economic agreements were notified [5]. Next to quantitative also quality changes in nature of the agreements in relation to regional integration were noticed [6]:

- firstly, it relates to transition towards the open model of regional integration, as it's development is directed to the international trade promotion, but not on the trade and economic collaboration control (as it was typical for indigenous conception of regions development);
- secondly, in regional trade agreements with the reduction in tariffs and quotas other barriers mechanism disposal is also determined and it also promotes deep integration

- development of the countries, the achievement of which needs broad-based political measures (as it was done in the EU) which moves beyond a traditional trade policy;
- thirdly, in the world practice there has been enhanced trading blocs appearance, which combined countries with the different social and economic development level and income, but which are considered as equal partners within the complied regional-trade arrangements by type North-South (beginning of this process is related to the compilation of the agreement regarding North-American Free Trade Area organization);
 - fourthly, it is noticed the increasing of the regional trade agreements amounts which are compiled between remote countries, development of collaboration between which is based on the principles of strategic partnership which is not necessarily related to the factor of geographical proximity and boundaries generality.

The enhanced monitoring of RTA as institutions, as well as their statistical research is complicated by several circumstances. Regional trade agreements include goods and services, however a statistical base which is formed by the WTO calculates separately trade agreements related to goods, and trade agreements related to services (it vastly increases the general amount of RTA) and a database takes into account the adherence to already existing agreement, as a separate new regional agreement. Besides, the most important fact is that not all regional agreements are notified in the WTO (first and foremost it is related to integration agreements, which are concluded between the developing countries), at the same time they are strongly active. Another peculiarity is if countries which conclude RTA are not the members of the WTO, a similar agreement is not taken into account in the world statistics, so that's why it is possible to consider that the actual amount of the concluded RTA is considerably larger in a modern world economy.

Regional integration agreements also considerably differ one from other in relation to the goods coverage and liberalization depth depending on tariff and non-tariff measures usage. What considers goods coverage, all agreements comprise industrial products (with certain exceptions), and almost all of them do not include an agricultural production, products that did not complete the primary processing (fishing and forestry products) and the mining industry products.

The exclusion of the agricultural products took place through restrictive trade policy support by majority of the governments in this sector, in the context of the national farmers support programs. Regarding to the industrial products, its certain list was existed. In relation to the depth liberalization, defined by integration agreements member-countries, it is necessary to notice, that the most previous agreements, concluded between the developing countries, was designed to partial tariffs reduction, when at the same time, agreements between the developed countries progressively removed tariffs in relation to the products covered by the agreement. Some agreements eliminate the usage of non-tariff border measures between member-countries, such, as the import licensing, anti-dumping and counterbalancing measures. In fact, only in the EU, the liberalization of border trade was completed between its members through the removal of tariff and non-tariff measures related to all products. Including these reasons a term «Free Trade Agreement» covers the agreement with the different lists of products and liberalization depth.

2.2. The evolution of the regional integration regulation within the global institutional architecture and, actually, the establishment and development of regionalization is fluctuating and classified in such stages.

The first phase (1950–1970) is related to the strengthening of integration tendencies between neighbouring countries with domination of horizontal or latitudinal integration and involves the level of countries North-North, South-South. Regional trade agreements that were concluded in that period actually involved the countries with the similar development levels and which were located in one region. The main development task of regional convergent and integration cooperation was a mutual removal of tariffs imposed on the manufactured goods, and regional cooperation assistance for the purpose of regional coordination achievement.

The state institutions were acting the key role in the development of regional convergent and integration associations. The first successful results of economic convergence and integration development in the EU countries urged the strengthening of integration processes between the developing countries. It was at that time when decisions about institutions of European integration development were made, as well took place the first attempts of the association of the countries with the low level of economic development, which recently inherited sovereignty from former metropolises.

In this period a tendency to strengthening of regional convergence is visible, when some agreements between countries were ceased to be effective, and some of them were either actually replaced or modified by previous ones [7; 8]. It is related, primarily, to the agreements concluded between countries that had developed, and the agreements within the EU. However, the sheer number of agreements did not specify the world trade coverage part of the countries and on the volume of coverage by the trade liberalization, tariff measures applicability and their influence on trade in goods. These and other aspects of the notified agreements are important for understanding the cooperation between regional and multilateral integration on the present time.

The second phase (the second half of 1990th, 1980th) is characterized by the new liberalism development together with globalization strengthening, which influenced on the transformation of ideas of regional coordination in the direction of regional development effective models determination, which is based on a competition mechanism, with the active use of regional policy instruments. In this period, intensively developing across regions integration is observed, the effectiveness of which involves the collaboration between countries by type North-South, also starts the development of regional trade agreements (and consequently the growth of integration associations amount), which became a certain alternative to the global institutional mechanisms for trade relations adjusting.

The third phase (early 21st century and so far) has been marked by the development of the new-wave of regionalization, which is related to strengthening and deepening convergent and integration cooperation of the South-South countries, where among the developing countries, initiators of integration cooperation are those with a higher level of economic development take the lead (India, Brazil, China). This period differs stormy development of regional integration initiatives, which already exceeded the framework of continental regions and have more complicated content of convergent collaboration: liberalization involves not only trading in goods, but also trading in services, electronic trade, investment regime, adjusting of the public purchasing mechanism, intellectual property protection, ecological questions (table 1). The specific aspects of the new stage of regionalism directly predetermine a dynamics and development directions, not only of the convergent and integration associations, but also of the national economies, as a list of questions which involves the similar RTA, are close in terms of content to that one which is viewed within the limits of multilateral negotiation process.

Table 1. Criteria for «close» and «open» regionalism*

Criterion	«Close regionalism»	«Open regionalism»
Tariff and non-tariff measures removal	+	+
Customs tariff level	high	Low
Preferential trade agreement with countries with relatively low level of development	+	+
Compensation system establishment	+	+
Promoting the external export development	low priority	high priority

*Reference: [7]

The new qualitatively forms of regional and global convergence display makes important the engagement to convergent and integration processes occurring in a world economy, of all the countries, irrespective of the development level achieved.

On the modern stage there is a loss of discredit to the multilateral institutional regulation mechanism through crisis phenomena dissemination in a world economy, food and energy safety focusing, unstable commodities and energy products price condition, deceleration of the international negotiation process under the auspices of the WTO and so on. All of this stimulates the development of the regional initiatives, including the same towards of regional development integration.

In accordance with the Doha declaration adopted by the countries of G20 [9], has been noted that every country has the primary responsibility for own economic and social development, and in the conditions of interdependence of national economy and global economic system the effective use of trade and investment possibilities will help countries to ensure the economic growth and get through the social problems, related to inequity of profits in society (these problems are particularly relevant to the developing countries). Practically, all existing in the world economic and convergent integration alliances with the participation of the countries, which have different levels of socio-economic development, at the time of creation declared almost identical tasks, namely: expansion of market space, creation of liberal external trade and favourable foreign-policy environment, issues of particular concern, related to ensuring of the economy growth and welfare. However, if for the advanced countries the deepening of convergent cooperation could be viewed as a certain function from already achieved level of development, but all other countries consider convergence, as a method of improvement of their socio-economic position.

The openness of the economy achieved through reducing barriers to the free flow of capitals and goods, is not directly related to the economic growth, increasingly, it depends on the effective internal strategy and institutional policy presence, which form sufficient adaptation to the changes of global environment and provide integration to the world space on a parity basis [5]. The evolution of the crisis in a world economy had a significant impact on the trade barriers increase and proper strengthening of protectionism tendencies in the national trade and economic policies. However, due to the current system of the multilateral regulation of trade and economic relations,

which is ensured by the pre-described institution such as the WTO, substantial growth of protectionism has been contained.

The new import restrictions, which had been implemented within the framework of anti-crisis measures, only in the country-members of G20 during 2008–2009 covered 0,8% of the world trade and included 66 trade barriers and 47 other measures [10, p. 49] of trade restriction. During the next period (2009–2010) restrictions were reduced more than a half, but, anyway they represented 0,4% of the world trade general volume. Anti-dumping procedures began actively used by the countries as a protective method, the amount of which also grew in the crisis period (the basic part of anti-dumping procedures (27%) were applied to the goods made in China) [11, p. 10].

The taxes usage as a facilitative mechanism was more disseminated among the world developed countries (42,9% from a total volume), among some developing countries, their volume also was considerable (Russia – 31,3%, Chile – 46,0%, Indonesia – 76,9%), although on average in this group of countries it was 16,4% [12, p. 98]. At an average, for the development of stimulant initiatives by the countries of the world during 2010-2015 the significant amounts of fiscal incentives were directed: by the developed countries of the world on average approx 2,1% of GDP, by the developing countries 5,6% of GDP. The greatest package of stimulant measures by volume was realized by the developed countries – the USA and Japan, among the developing countries – by China [13].

Besides, economic inequity and insolvency of global governance influence on the development considerably more, than other global risks, and obstruct effectively to react on them. Solving the problem of the global governance improvement has a great importance [14].

The process of regional convergence development has own logic, and that is why cannot be fully regulated by a unilateral decision on the part of such global institution, as the WTO, as the development of convergent integration blocs foresees the creation of the own system of supranational institutions. On such conditions, arise a certain contradiction of trade and economic relations settlement between the WTO and a special mechanism of RTA realization, which exists today and needs the proper decision. At the same time, the WTO exactly provides the unique rules for world trade development which creates fair, non-discriminatory, mutual nature of trade and economic relations between the all countries of the world economy. Under crisis condition of the world economy development, namely, the multilateral mechanism of trade relations regulation did not let the protectionism measures to spread, which began to be used by the countries for national economies defense.

Unilateralism of the USA triggered in the western scientific circles a big discussion related to the subsequent prospects of the multilateral collaboration between the EU and the USA within the framework of the existent international institutions. In the post bi-polar world, with its variable market condition, the coalition can not exist for indefinite periods due to coherency lack between collective and individual participants interests of the similar associations (sometimes they are inclined to intentions information exchange, then how exactly this condition is one of the most important for general decisions approval). In addition, the variety of the international institutional structures and organizations makes the effective implementation of decisions impossible, accepted on the multilateral basis [15].

Unlike unilateralism, the basic postulate of multilateralism consists of the following: limiting the freedom of action of the state in the process of its collective cooperating with the other international institutes is compensated by the additional possibilities, which enable all participants

of multilateral process to achieve the common goals. On the understanding that every partner has certain comparative advantages in a particular sphere, the joint efforts of the all participants of collective actions can succeed, what cannot be realized in the case of activity independently by every participant. And though the collective procedures of decision making are intended to ensure the balance of interests and on this basis realism and the decisions achievement, are remained as the basis of multilateralism, the content of this concept will change. To that end the EU post bi-polar regionalism, the new qualitative type of regional collaboration, which was formed under the conditions of the global system depolarization of the international relations and the restructuring of the resistant world balance and to its feature belongs the advantages of equal partnership in a counterbalance to the countries – regional leaders’ dominance upon small states.

2.3. A competition between regional trade agreements and multilateral trade system actually defines the identity of mutual relations between regionalism and multilateralism. However, this competition has complementary nature in the trade liberalization and integration initiatives as a result of synergy between regional and multilateral negotiating processes, designed to trade and markets openness development. The next step of development will be the taken over of these two strategic directions in terms of the better experience and results, therefore regional integration agreements will become the important element (the blocs of construction) of the multilateral system of trade and economic relations regulation.

The mechanism for resolving issues of normative nature needs the subsequent development, particularly through intensification of the negotiation process under the auspices of the WTO within the framework of the Doha round, directed on the alignment of the multilateral mechanism supervision after the RTA, in order to provide their transparency, determination and alignment of the particular formulations, procedures and norms, specific for the noted kinds of agreements etc. The rules, that regulate the development and RTA activity on a part of the WTO, have lack of efficiency, and consequently, acceptance of the new institutional mechanisms of trade cooperation on multilateral and either on regional level are needed. The significant step of this regulation mechanism development is the acceptance of the WTO member-countries of the «Compendium provisions which regulate regional trade agreements». The effect of the compendium is directed for the transparent mechanism establishment of RTA development within the limits of multilateral trade system. This mechanism of transparency involves such elements: period determination submission of RTA conclusion; providing of availability and completeness of the statistical information which characterizes regional grouping activity; an obligatory submission report about the grouping participants’ obligations; the improvement of RTA multilateral supervision mechanism that provides the system analysis, requirements uniformity etc.

In accordance to the Compendium a submission period about the RTA conclusion is defined, however, the period within the members of the WTO must be informed in relation to a new agreement, are not clearly defined by the current requirements, and consequently, as a result, in practice a lot of RTA are notified after the publication or implementation. In compliance with the Article XXIV 7(a) of GATT: a term «should immediately notify» is interpreted as the notification of RTA on the part of the WTO should take place prior to the entry into force and the period of the preliminary statement should not be shorter than 90 days (Article V: 5 of GATT). The settlement of RTA still remains problematic, which are entered into force without notification in the WTO. First of all, it concerns the preferential agreements between the developing countries. Actually, RTA should cover all the economy industries without an exception, and a transition period must have the

limited terms (possibly not be greater than 10 years) and foresee the clear timeline for trade liberalization in the separate industries. As a result of regional agreements application, the common customs tariff which is being implemented within the limits of the Customs union, should not exceed the lowest tariff existed in a country with the lowest tariff in the relevant industry, or even the lowest tariff, within the limits of the preferential treatment regime.

In general, convergence and integration should be estimated in terms of is it a step towards increased freedom of trade or, conversely, a limitation towards to trade flow. In accordance to the rules of GATT/WTO, there is an exception from the preferential treatment regime, namely, the article XXIV of GATT, which is the basis of regional integration agreements development and foresees the possibility of customs unions and free trade zones creation. In accordance to the rules, before convergent and integrated groupings creation, the existence of «transitional agreements» for a sufficient length of time is possible, which should result the Customs union or free trade zone formation through the «wise period» in conditions that trade barriers between members are removed on «almost all» goods, and trade barriers with other countries are not at least increased.

The main reason of progress absence within the framework of the last round of negotiations are the requirements of some member –countries of the WTO to the developing countries, in relation to the tariffs decrease from the side of those other countries on their own non-agricultural products to the level inherent the developed countries at presence, that significantly limits the export capacities of the developing countries, and also agricultural subsidies for the local producers, widespread among the developed countries. All of that considerably limits the markets access for the developing countries, and which are nowadays exactly interested in export-oriented models of the development. Anyway, the difficulties of the negotiation process within the framework of the Doha round could be systematized as follows:

- the negotiations lasted before were quite successful, as involved the basic part of the manufactured goods and mainly did not concern the problematic groups of «sensible» goods and procedures related to them (trade of services and agricultural products, support of agro-industrial production, anti-dumping measures, and so on);
- previous rounds of negotiations, as usual, were concentrated on tariffs which are easily enough to be measured, and as a result are easily to be discussed;
- separate appendixes to other issues of the discussion have slowed the progress of negotiations;
- variety of interests and priorities of the country-participants of the negotiation process influenced on negotiations agenda forming;
- the developed countries of the world economy are promoting a thesis related to the sectoral approach development (production of electronics, chemical products, industrial equipment, and so on) in the opposite of markets opening of the developing countries (especially, such as Argentina, Brazil, China, India);
- the discrepancies in the usage by the developing countries of the special protective mechanisms related to the agricultural producers, where the tariffs level becomes higher in accordance with the preference treatment regime level (the developing countries insist on the temporal usage of the high tariffs in defense of internal market protecting from the import increase).

The complexity of solving the problems within the limits of the Doha round, the practice of dissemination of bilateral RTA, in any way calls into question the distribution of the idea of the

multilateral trade system rule based by the WTO. Regional trade agreements significantly divert from the higher purpose of the multilateral regulation mechanism, although the WTO through the existent mechanisms system prevented strengthening of protectionism during the last world financial crisis, that, from one side, did not let the the Great Depression of 1930th scenario development to repeat through the constant monitoring of trade and investment measures that were used by the countries during the crisis. From the other side, namely the global crises phenomena figured out the discrepancy between current agreements and institutional structures that act at a global level, in such important question of the world economy development, as declining of the world economic imbalance. Hence, exactly the regional institutions and agreements can transform into an important element in the structure of the modern global management, since they are able to adapt global agreements in accordance to the regional specific, in this way providing their effective realization.

In the conceptual debates «regionalism-multilateralism» RTA are characterized, in such a way, with faster pace than development of the multilateral regulation system, and are not compatible with its objects, and vice versa, contribute to strengthening. However, the principles of regional agreements functioning often go beyond the WTO principles, and consequently, there is an objective necessity of relations settlement between member – countries of the WTO, which are the participants of RTA, and other member –countries of the WTO, which are not included in regional groupings, provisions harmonizations of regional and multilateral regulating mechanisms and so on. In such circumstances, the WTO objective should become the providing of initiatives development of the WTO country-members from bilateral to more difficult multilateral, that enable to realize the principle of non-discriminatory world trade. Respectively, the regional integration can not become an alternative of the multilateral mechanism of the trade regulation; it should be transferred into the important element of this mechanism.

The practice demonstrates that in conditions of conclusion between the countries of asymmetric regional trade agreements (asymmetrical trade agreements) trade preferences does not have at an end mutual basis, that means, that the country concerned would be entitled within long time to implement the trade preferences than the other one (it concerns a few countries concluded the proper regional agreement). Such incidences in the international practice most frequently covered RTA, which are concluded between the developed countries and the developing countries («North-South»), and within the framework of which, the certain period of time for adaptation of the less developed countries to the trade conditions is determined (and if the more deep integration is expected, to the investment and production conditions) which nowadays exist in the developed countries. During this period, within the limits under the agreement, by the less developed countries from the side of the developed countries some preferences are provided (trade concessions, technical help related to trade, production and investment).

And in a way, countries which conclude various RTA establish their own trade regime within the limits of the general multilateral trade regime, which is regulated by the the WTO. The principles of RTA functioning often go beyond the WTO principles whose activity is focused on the trade liberalization deeping and strengthening of the international trade flow intensification within the limits of the multilateral trade system.

Accordingly, for the harmonious development of the world economy the mutual relations settlement between member –countries of the WTO is necessary, which are the participants of RTA, and between third member-countries of the WTO, in the global trade system.

The research suggests that large numbers of RTA contains provisions which nowadays are beyond of the WTO rules, so-called the WTO-x provisions. They entered into more than one third of regional agreements, they are widely enough presented in the acting RTA (figure 1), and their appearance is related to the Doha Round: particularly it concerns a competition policy (47 % of all the agreements), movement of capital (39 %), intellectual property rights, which are not subject to the agreements (37 %), investments [16, p. 3].

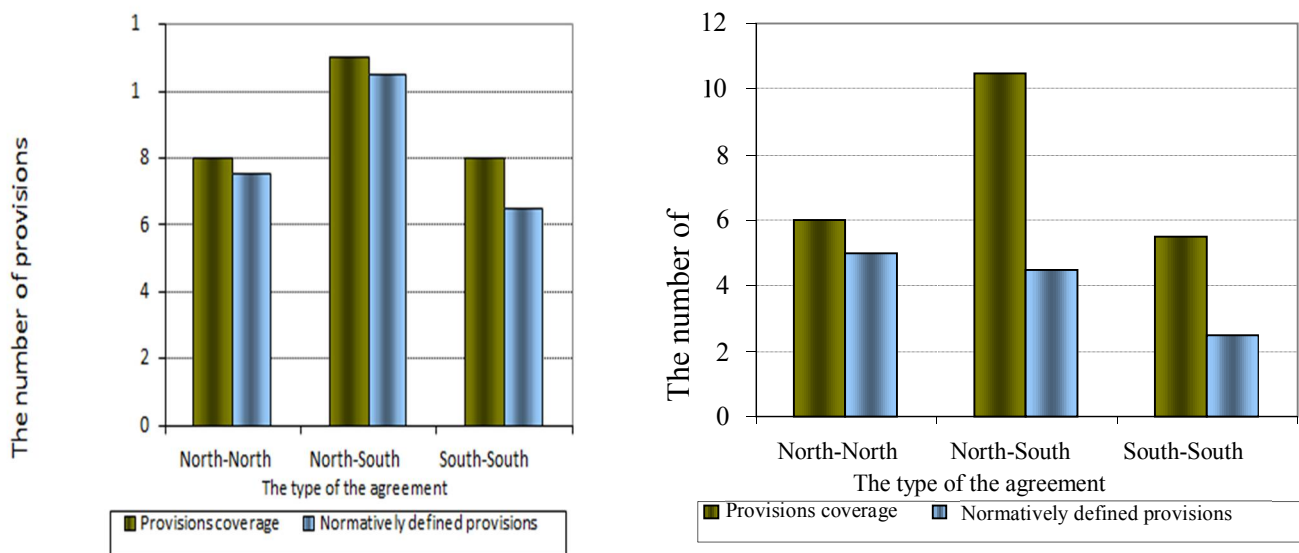

a) the provisions of the WTO+ b) the provisions of the WTO-x

Figure 1. The average number of the WTO+ and WTO-x provisions of regional trade agreements*

*Calculated and constructed by the author on the basis of the reference analysis [17]

The third of RTA involves the question of ecological norms, labour-market regulation, visa questions and so on [17]. In addition, they contain the positions, which involves more deep integration in those industries which are covered by the WTO rules (provisions of the WTO+, which involve industrial and agricultural tariffs, technical barriers, trade of services, by intellectual property rights and are contained in RTA of all types (North-North, North-South, South-South). However, the WTO+ provisions are extending the existing provisions of the WTO; it is up to them to be accepted as soon as possible on the multilateral basis by comparison to the WTO provisions.

3. Conclusions.

Forming of three basic models of regional integration in a world economy actually results the competition strengthening with the multilateral regulation system related to the establishment of the interregional standards not only in relation to the traditional goods but also for the information technologies products, nanotechnology, biotechnology and other products of the «new economy». However, the intergovernmental economic spaces forming, which are established on the basis of continental and transcontinental models, actually stimulates development of the multilateral regulation system.

The fact is that regionalization of the world economy, which is manifested through certain structuring of external competition environment, where the new countries are brought, requires harmonization of not only the interregional, but also the universal norms, regulations and standards on a multilateral basis. As a result, there is the regimes converging, which are set up within the convergent and integration associations, and consequently, the further development of the global regionalization (that foresees the continental and transcontinental models of regional integration development) takes place in dialectical unity with the multilateral regulation system, which is provided by proper international institutions.

References

1. Lukianenko, D. H. (2001). The strategies of the economic development in the context of globalization. Kyiv: KNEU.
2. Hardacre, A. (2009). The EU and the Diplomacy of Complex Interregionalism. *The Hague Journal of Diplomacy*, 4, 167–188.
3. Kulisher, I. M. (2012). The key issues of the international trade policy. Moscow: Sotsyum.
4. Dovhan, V. (2009). The right of the World Trade Agreement. Ukraine's WTO accession. Kyiv: KNT.
5. Regional Trade Agreements Information System. (2020). Retrieved from <http://rtais.wto.org/>
6. Shyff, M. (2005). Regional integration and development. Moscow: Ves mir.
7. Gerchikova, I. N. (2002). The international economic organizations: training manual. Moscow: Konsaltbankir.
8. Pakhomov, Y. M., Lukianenko D. H. & Hubskiy B. V. (1997). National economies in the global competitive environment. Kiev: Ukraine.
9. The G20 Seoul summit leaders' declaration (2010). Retrieved from https://www.fsb.org/wp-content/uploads/g20_leaders_declaration_seoul_summit_2010.pdf
10. Baldwin, R. (2009). The Collapse Of Global Trade, Murky Protectionism, and The Crisis: Recommendations for the G20. London: Centre for Economic Policy Research.
11. International Trade After the Economic Crisis: Challenges and New Opportunities (2010). N. Y.: United National Publication.
12. Economic Report of the President (2013). Transmitted to the Congress. Together with the Annual Report of the Council of Economic Advisers. United States: Government Printing Office Washington.
13. Trade and Development Report (2019) Retrieved from https://unctad.org/en/PublicationsLibrary/tldr2019_en.pdf
14. Global Risks (2019). World Economic Forum. Retrieved from http://www3.weforum.org/docs/WEF_Global_Risks_Report_2019.pdf
15. Trans-Pacific Partnership: 13th Round of TPP Negotiations Set for an Diego. Retrieved from <http://www.ustr.gov/tpp>
16. Bhagwati, J. (2011). World Trade And The Doha Round London. Retrieved from www.nationalarchives.gov.uk/doc/open-government-licence
17. World Trade Report (2019). Retrieved from https://www.wto.org/english/res_e/publications_e/anrep19_e.htm

Iryna Udovychenko

Doctor of Pedagogical Sciences, Associate Professor, Vice-Rector Sumy Regional Institute of Postgraduate Pedagogical Education,

Sumy, Ukraine

orcid.org/0000-1980-5402

COMPETENCE APPROACH OF TEACHING LEAN-LOGISTICS IN GEOGRAPHY LESSONS AT THE PROFILE LEVEL

Abstract. *The article actualizes the expediency of forming a competent school graduate by means of teaching lean-logistics in geography lessons. The content component of the course «Lean-logistics in geography» developed by the author is reflected. Requirements for the evaluation of students' educational and cognitive achievements in the process of mastering the content of the proposed authoring program are highlighted. The attention is paid to the urgency of the development of educational and methodological support in the process of teaching lean-logistics on geography lessons at the current stage of development of education in Ukraine in the context of competence approach and implementation of cross-cutting content lines.*

Introduction.

At the present stage of development of school geographic education, the content of current methodological research presents scientific substantiation of ways of improving the quality of education, which corresponds to the basic provisions of the State standard of basic and complete general secondary education [7].

A competency-based approach to education is responsive to the demands of time and requires participants in the educational process to be able to adapt quickly and flexibly to new requirements: from students to apply their knowledge in dealing with non-standard situations, and from teachers the ability to competently organize learning activities and effectively direct it.

Society now needs advanced pedagogy with an effective system of intellectual and psychological development of the individual, which contributes to the formation of: creative and critical style of thinking; ability to analyze any problems, establish cause and affect relationships, identify contradictions, predict likely options for completing educational tasks, including professional orientation.

The current stage of reforming education in Ukraine is characterized by improving its content, increasing the amount of information needed and at the same time reducing the time spent on its acquisition, and the level of education of students and educators is determined not so much by the volume of knowledge, but by the willingness to solve problems of varying complexity (on the basis of skills, attitudes), competences, including global ones, to which the process of teaching geography at the profile level in general secondary education institutions is directed [8].

In this context, it is appropriate, in our opinion, to supplement the geocentric content of education with elective courses of competence. Thus, in our opinion, it would be expedient, to supplement the course of geography (profile level) for the 10 – 11th. classes with electives, special courses, elective courses of topical, modern and interesting for the students of the upper classes of subjects, the study of which will facilitate their mastery of sections, topics of study programs at a high theoretical level [2].

1. The use of a competent approach and content lines in the implementation of the course «Lean-logistics in geography»

Our initial analysis of the study of lean-logistics in geography allows us to argue that this issue was not considered by scientists from the point of view of the competency-based approach and profile training, which makes it relevant in our time and is the subject of our study and the article is clearly outlined in the goal, such as: updating the feasibility of forming a competent school graduate by means of teaching the content of the course «Lean-logistics in geography».

As our original analysis proves, the question of lean-logistics in geography has largely not been considered by scientists at an angle view of teaching at the profile level students of general secondary schools education.

For the most part, logistics was considered as well as by foreign and native scientists at different times, from the perspective of logistics administration (E. Krykavsky [4], N. Chukhray [4], etc.), marketing logistics (M. Kristopher [5], H. Peck [5], etc.), logistics management (T. Lepeyko [6], V. Ponomarenko [6], K. Tankov [6], etc.) and others.

However, despite the abundance of research, it is currently lacking methodology, methods of teaching logistics and studying lean-logistics by students of educational institutions at the profile level, which has led to the interest in this problem and prompted the justification for the implementation of logistics strategies in practice of teaching geography students at the profile level, generalization methodological tools for the implementation of the elective courses of logistics direction to the practice of general secondary education institutions for the purpose of formation a competent graduate.

Logistics is therefore, considered to be an economic, management and marketing term. However, at the present stage it is quite widely included in our vocabulary and is used by it, talking about logistics of goods and services, logistics of tourist movement and construction of tourist routes, logistics of entry and demand of professions in the labor market, which requires the students to study this concept in order competent positioning yourself and adherence in adulthood.

Implementation of the competence approach as the theoretical and methodological basis of modern general secondary education implies significant changes in the learning process: its goals, content, organizational forms and methods, means, results, etc., given its integrated nature.

The geography curricula of the 10-11th. grades provide for directing the content of education to the formation of subject geographical competence, cognitive interest of students, the development of their intellectual and creative abilities, through the organization of independent learning activities, the process of finding and processing geographical information.

In this context, in order to teach geography at the profile level of 11th. grade students, in our opinion, it would be advisable to introduce an course «Lean-logistics in geography» course in the curricula of general secondary education institutions, which plays an important role in the structure of the profile education of high school and related to the satisfaction of individual requests, inclinations and needs of students; aimed at modernizing the educational process in geography, expanding knowledge of the subject and has an integrated character, so it is considered as subject-integrated.

The main ideas of the course – integration, economization, greening, sociologization, humanization of the geocentric content of education, involvement of students in the implementation of research, designing in geography, pragmatic activity by means of modern geography, with the help of a new form – logical practices.

The aim of the course is to improve the understanding of logistics flows and to establish the concept of logistics as a science based on integrated and complex approaches in the formation of geographical thinking and holistic perception.

Tasks of the course «Lean-logistics in geography»:

- to deepen the geographical, economic and social education of graduates of general secondary education through the study of the basic concepts of logistics, history and stages of development of logistics, functions and types of logistics, its role and place in different areas of human life;

- to orient the individual to individualization and independence in the process of making their own logistics decisions;

- to improve the concept of logistics as a science;

- to familiarize with varieties of logistics flows;

- to identify the individual logistical abilities of students, in accordance with their chosen direction of profiling;

- to create conditions for students to realize themselves as logisticians;

- to deepen geographical and socio-cultural knowledge;

- to develop geographical, spatial, logical and creative thinking;

- to develop logistical skills and abilities;

- to promote the choice of future professional activity;

- to form a geographical, economic, ecological culture and a comprehensive geographical worldview;

- to form a competent graduate of an educational institution competitive in the market of the requested professions;

- to educate a culture of communication;

- to supplement educational and methodological support for geography with new teaching aids;

- to create optimal pedagogical conditions for teaching students at the profile level [11].

Didactic and methodological features of the course «Lean-logistics in geography»:

- elective course is a superstructure of a geographical profile;

- promotes satisfaction of cognitive interests and individual characteristics of students in different fields of human activity;

- extends the content of the geography of the profile level of study, which allows to use thematic information in the process of mastering the content related subjects;

- reflects the content of the curriculum that is fundamental to the creation of this course and does not repeat the content of the academic, profile levels of education.

The structure of the curriculum developed by our course «Lean-logistics in geography» consists of an introduction, 3 sections, 10 topics with orientated content, 5 logic workshops (logistic workshops – a new form of active practical activity of students), reserve hours (0,5 h), expected results (general and specific) of students' educational and cognitive activity (knowledge, activity, value components); from the calculation of study – 1 hour per week for a total duration of 17,5 hours during the semester.

The curriculum of the course, which is of a framework nature, is based on the principles of regularity and continuity of school geographical education, integration of internal and cross-curricular links.

The content of the curriculum presented in the context of the four cross-cutting content lines of the new Ukrainian school:

- environmental safety and sustainable development;
- civil liability;
- health and safety;
- entrepreneurship and financial literacy

and aimed at: studying the concept of logistics, its history, stages of development, functions, types, role and place in human life; development of applied modeling skills, use of logistical knowledge and introduction to students' vocabulary of such concepts as:

- logistics;
- logistic chain;
- logistic operation;
- logistic service;
- logistic system;
- logistic function;
- logistic cycle;
- logistic workshops, etc.

In order to implement the practical component of the curriculum of the course «Lean-logistics in geography», a new form of work is proposed – a logistic practicum, as a means of active educational activity and a pragmatic form of creative activity for the development of logistic skills. According to the structure of the course, 5 such logic practicum are offered, with 6 hours of the curriculum, and which provide the development of practical skills of modeling lean- (city, production, mail, shop, etc.), design spatial models of logistics flow and more.

In addition, the content of the proposed program is career-oriented, as it introduces senior students to such professions as logistics, manager, provider and specifics, geography of the location of educational institutions in logistics.

At the same time, the implementation of the content of the elective course program is aimed at revealing the facts, processes, phenomena from the perspective of four cross-cutting content lines (environmental security and sustainable development, civil responsibility, health and safety, entrepreneurship and financial literacy), the formation of key, overall – subject geographical competencies (table 1).

The content line «*Environmental security and sustainability*» is implemented in geography lessons through the tasks of economical logistics, sustainable development of the country. Such examples are provided by material on rational and economical use of nature, etc. [1].

The result of the implementation of this content line is not only the students' awareness of environmental problems, their awareness of the possibility of solving these problems, both applied and theoretical – natural sciences, etc., but also the formation of environmental, global competence. In such circumstances, students learn to appreciate the natural resources on which their health, well-being, and sustainable development of the country depend; aware of the need to preserve the cleanliness of the environment; participate in appropriate activities; environmentally-minded behave in the environment.

It is advisable to master the content of lean logistics in order to implement the content line «*Ecological security and sustainability*» in the process of teaching geography at the profile level of students in grades 10-11th.

Table 1. Characterization of cross-sectional content lines of geography training at the profile level

№	Cross-cutting content line	A brief description of the through content line
1	Environmental security and sustainability	<p>Formation of a responsible, environmentally conscious citizen, ready for active action in the environment, in the context of awareness of the variability and transience of space-time components, the importance of sustainable development for the future.</p> <p>The through line is implemented through the implementation of logistical tasks in modeling lean- (city, production, mail, shop, etc.), tasks with real data on the use of natural resources, their conservation and multiplication. The analysis of these data contributes to the formation of critical thinking.</p> <p>Possible lessons in real and virtual space (office, meteoport, ecological path), logistic workshops.</p>
2	Civil liability	<p>Formation of a tolerant, responsible member of society, community, family, who understand the principles and mechanisms of functioning of society.</p> <p>The cross-cutting line is realized through making tasks of competence direction, construction of spatial models of logistic flow, means of collective activity (research works, group work, projects, logistic workshops, etc.), which brings together students in the process of joint task fulfillment. The study of geography should evoke as many positive emotions as possible (emotional intelligence), and its content should be aimed at fostering responsibility, honesty, thoughtfulness, diligence, consistency, honesty; formation of civil liability. The implementation of the content line is possible by the use of tasks of competent direction with the justification of their civic position.</p>
3	Health and safety	<p>Formation of an emotionally resilient member of society, a team capable of leading a healthy lifestyle, forming a safe living environment.</p> <p>The through line is implemented with the help of tasks of competence, active exercises to develop healthy lifestyle skills (culinary geography, sports geography, and tourist logistics), safety of circulation (traffic, fire safety, military logistics, and conflict studies), lean-logistics (demographic processes, info logistics).</p> <p>Solving problems associated with the search for optimal methods for solving and fulfilling tasks, mainly practice-oriented, using logistic workshops.</p>
4	Entrepreneurship and financial literacy	<p>Formation of financial literacy by means of applied economy, development of entrepreneurial traits and leadership initiatives, ability to successfully act in the technological fast-changing environment, providing students with better understanding of practical aspects of financial issues (demand, supply, inflation, savings, investing, borrowing, insurance, borrowing, insurance), business logistics.</p> <p>Cross-cutting is realized by solving practical problems of business planning, lean-construction and real assessment of their own capabilities, family budgeting, determining logistics costs, designing spatial models of logistics flow, forming an economical attitude to natural resources.</p> <p>It is possible to implement project activities in the direction of eco-packaging by means of logistic workshop.</p>

The implementation of the cross-cutting content line «*Civil liability*» in the lessons of geography contributes to the formation of students as conscious citizens, patriots of Ukraine, members of society, community, and staff. In order to master the content of this line, students learn to work in a team and to be responsible for team tasks, to do their part carefully. The results, which certify the productivity of the implementation of the cross-cutting content line «*Civil liability*», are the students' awareness of the responsibility for the learning outcomes, in the future – for the results of work, civic position, decisions that may in the future affect the development of the country [3].

It is advisable for the purpose of realization of the content line «Civil liability» in the process of teaching geography at the profile level of students of 10-11th. grades is to master the content of urban logistics, info logistics, logistics in geography; acquisition of skills in logistic design of entry logistics (to higher education institutions), logistics of family life and more.

The content line «*Health and safety*» refers to the tasks of developing healthy lifestyle skills (culinary geography, sport geography, tourist logistics), handling safety (traffic, fire safety, military logistics, conflict studies), lean-logistics (demographic processes, info logistics).

As a result of the implementation of this content line, the student adheres to the rules of safe behavior in the study room, life and environment; is aware of the dependence of health on cleanliness of the environment; adheres to a healthy lifestyle [1].

In order to implement the meaningful line «Health and safety» in the process of geography training at the profile level of students in grades 10-11th., it is advisable to acquire knowledge on tourism logistics, self-realization logistics, logistics services and security operations and to minimize risks to humans. The cross-cutting content line «*Entrepreneurship and financial literacy*» aims students to mobilize knowledge, practical experience and value attitudes in situations of choice and decision-making in the financial and economic direction [3]. In training, such situations are created during the planning of self-educational activities, group study and research work, the implementation of training projects and the presentation of their results (products), the solution of situational exercises and the solution of practical problems in planning economic activities, lean-construction and real assessment of one's own business, logistic opportunities.

In order to implement the substantive line of «Entrepreneurship and financial literacy» in the process of geography training at the profile level of students in grades 10-11th., it is advisable to master applied business logistics and acquire knowledge on stock logistics; procurement, distribution, logistics, transport, customs, warehouse, integrated logistics; practical skills in modeling consumer attractiveness, family budget, and so on. The implementation of new Ukrainian school substantive content lines (environmental security and sustainability, civil liability, health and safety, entrepreneurship and financial literacy) requires increased attention of geography teachers to the organization of the learning process at a profile level, namely:

- the use of education integrators (universal concepts, fundamental theories) in the construction of integrated tasks (questions) from the point of view of four thematic positions (civil liability, financial literacy, environmental safety and health);
- structuring the integrated content of thematic courses (elective, students' choice, etc.);
- the use of exercises for the development of critical thinking of students with the justification of their citizenship as a member of the team (class, school, family, community, state);
- modeling of educational tasks of a competently oriented direction by means of implementing four substantive content lines (civil liability, financial literacy, environmental safety and health) with a projection to obtain high results of educational and cognitive activities of students in the aggregate of knowledge, activity, value components, etc. [10].

2. Features of evaluation of the results of educational and cognitive activity of students by the consequences of mastering the content of the program «Lean- logistics in geography»

The implementation of the content of the curriculum of the course «Lean-logistics in geography» involves the use of elements of the classroom system; active, interactive forms of lesson and extracurricular activities.

The orient content of the «Lean-logistics in geography» curriculum in the context of the implementation of substantive content lines from the projection onto the results of educational and cognitive activities of students (knowledge, activity, value components) will be presented as follows:

– *«Introduction»* (which means «Logistics». Logistics as a science. Logistics as a branch (function) of a corporation. Symbolism of the image of a logistics business. The cognitive and constructive role of logistics in the modern world. Logistics in geography. Sources of knowledge about logistics);

– *section I «Logistics theory»:*

topic 1 «General characteristics of logistics» (Logistic system. Logistic chain. Logistic operation. Object of logistic operations. Object of logistic operations in geography. History of the term «logistics». Stages of development of logistics. Functions of logistics);

topic 2 «Types of logistics» (Types of logistics Classification species groups of logistics. Military logistics. Business logistics. Material and information flows. Logistic costs. Urban logistics. Ecological logistics. Logistics tasks in the world and geography);

topic 3 «Economical logistics» (Economical (lean) production. The basic principles of lean-production. The history of lean-production. The main aspects of lean-production. Methods and concepts of lean-production. Types of costs of lean-production. Industry options for lean-production Lean-logistics. Economical healthcare. Lean-mail. Economical construction. Economical management. Lean-city);

– *section II. «Applied Logistics»:*

topic 1 «Military logistics» (Military logistics as a form of logistics. History of military logistics. Logistic system of military logistics. Military logistics flows in history and the present. Logistics support. Logistics in topography. Elements of military logistics in the geography of the settlement of continents and land conquest);

topic 2 «Business Logistics» (Logistics systems of business logistics. Logistics management tasks in practice. Purchasing logistics. Distribution logistics. Logistics is common. Transport logistics. Customs logistics. Inventory logistics. Warehouse logistics. Info-logistics. Integrated logistics. Business flows-logistics. Lean-business logistics. Business logistics in the Ukrainian economy);

topic 3 «Ecological logistics» (Ecological logistics and environmental safety of the world. Production processes and production wastes. Disposal. Unauthorized emissions. Lean conservation and environmental sound human behavior. Logistic flows of ecological logistics. Lean logistics of the ecological attractiveness of the regions of Ukraine. Logistics and geographical forecasting);

topic 4 «Urban logistics» (City logistics. Urban and rural population. Urban infrastructure. Megalopolis. Agglomeration. Urbanization. Types of cities, their functions and problems. Urban lean-logistics. Lean-logistics of demographic processes and population policy. Lean-logistics your locality);

topic 5 «Logistic services» (Logistics outsourcing. Logistics audit. Logistics providers. Logistics and logistics managers: professions, professional qualities. Logistics educational institutions. Museums of logistics);

– *section III. «Logistic design»:*

topic 1. «Lean-design of commodity flows» (Design in geography. Spatial models. Logistic flows in the field of economy. Logistic flows in the production of goods. Lean-design of commodity flows. Logistic design. Logistic flows in the agricultural sector. Logistic risks. Logistic advantages. Logistic weaknesses. Global «value chains» and «logistics chains»: common, different);

topic 2 «Lean-design in the service sector» (Lean-design in the service sector. Logistic flows in the service sector. Logistic flows in the transport sector. Logistic flows in the financial sector. Logistic flows in the field of education, science, culture, tourism and sports. Political geography and logistics).

Assessment of students' academic achievements in the course «Lean-logistics in geography» takes into account the expected results of educational and cognitive activities of students (in the context of the components of knowledge, activity, value components) (table 2) and involves taking into account the correctness and scientific character of the reproduction of educational material, competence disclosure of concepts and patterns, the accuracy of the use of terminology, evidence of judgments, reasoned conclusions, the presence of a creative approach to the implementation of logy practicum tasks, modeling in the process of activity of subjects of the learning process by knowledge levels:

–the initial (elementary) level, 1–3 points, is characterized by fragmented possession by students of educational material in the logistics area; recognition of certain types of logistics; an attempt to define them and build elementary logistics flows;

–the average (reproductive) level, 4–6 points, is characterized by reproductive actions, provides for the reconstruction of the model information; students determine patterns with the help of a teacher, partially describe logistic flows, explain the relationship in nature and society in a general way; distinguish individual logistic features observing the development of society, cannot always characterize them;

–a sufficient (reproductive-productive) level, 7–9 points, to a certain extent has a creative character, provides for sufficient possession of students with program educational material; the active use of evidence by relevant examples, facts, arguments; ability to describe logistic flows, put the acquired knowledge into practice; identify and correct errors, find ways to independently solve typical situations;

–a high (productive) level, 10–12 points, provides for a wide creative activity of students, full disclosure of the content of logistic concepts, patterns, relationships, comprehensive and correct answers, confirmed by convincing examples; the ability to make generalizations and conclusions on the results of practical activities; independently construct spatial models of logistic flows and argue their expediency [11].

Table 2. Expected general results of educational and cognitive activity of students in the course «Lean-logistics in geography»

№	Components	Expected overall results
1	Knowledgeable	knows, understands, calls, formulates, distinguishes, gives examples, explains
2	Active	applies, develops skills, distinguishes (recognizes), compiles, compares, characterizes, explains, explores, shows on the map, determines, detects, installs, knows how, describes, observes, develops, creates, processes, selects examples, finds , justifies, predicts, distinguishes, uses, models, constructs
3	Valuable	realizes, analyzes, evaluates, compares, makes judgments, is critical, draws conclusions

The content of the proposed program «Lean-logistics in geography» of the elective course contributes to the study of geography at a profile level, because it deepens students' knowledge of logistics and its derivatives, QR-coding (its creation and use), lean-logistics, out sorting, audit and development of such skills as: to distinguish spatial models, describe the features of logistics in space and time; skills development in designing, modeling, constructing, working with cartographic materials, etc. The use of such tools, forms, technologies, techniques in studying the content of «Lean logistics in geography», such as E-books, book trailer, hotlist, multimedia scrapbook, mind mapping (software), QR coding, Print Screen visualization, with active use of geographic information systems, educational Internet services, modernizes the learning process, attracts with the content, and through systematic use in practical activities makes them necessary and appropriate in the knowledge of geography.

The print screen of the logistic lotto «Lean-logistics in geography» illustrates the construction of intelligence models in the cognition of logistics by students of grades 10-11th. using test exercises in the form of tasks to choose one (or several) correct answer, establish consistency of cartographic modeling and info-construction and an example of the tasks of the questions bank of the thematic E-books, which add to the training program «Lean-logistics in geography», forming an appropriate training complex for the disclosure of the elective course content in logistics for the study of geography. Thus, the development and use of author's training programs by teachers, such as «Lean-logistics in geography», diversifies the educational process, makes it interesting and modernized, adapted to the needs and preferences of students, and their framework character helps teachers to implement a creative approach to the development of didactic support, structuring the content and construction of scientific and methodological knowledge of spatial and temporal patterns in geography and pedagogical modeling of subjects activity of geography teaching process at the profile level. Due to the framework nature of the «Lean-logistics in geography» curriculum, a teacher can be creative in realizing its content by selecting objects of study and K-direction tasks. A teacher can vary the hours for studying topics, sections, the implementation of practical training from a reserve of time taking into consideration the students' level, their preferences.

Conclusions

Thus, by introducing elective courses of competency in the educational process in the geography and in accordance with the requirements of the Concept «New Ukrainian school» [1], it is directed to the formation of key competencies:

- communication in the state and foreign languages;
- mathematical literacy;
- competencies in the natural sciences and technologies;
- information and digital competence;
- ability to learn throughout life;
- social and civic competencies;
- enterprise;
- general cultural literacy;
- environmental literacy and a healthy life are embodied in the results of education (knowledge, skills, attitudes), which is especially relevant at the present stage of development of education and forms the conceptual basis for organizing the process of teaching students geography of grades 10-11th. a profile level, that is the content of the components («skills», «attitude», «learning resources») obtained in the process of mastering geography, which were embodied in the

results (knowledge, activity, value components) of obtaining general secondary education (general and concrete expected results).

Key competencies such as communication in the state language, the ability to learn throughout life, competencies in the natural sciences and technologies, initiative and enterprise, environmental literacy and a healthy lifestyle, digital information [9], social and civic competencies, to a greater degree than others, can be formed immediately by means of all subjects, forms of extracurricular activities, which is substantive content lines are aimed at (environmental security and sustainability, civil liability, health and safety, entrepreneurship and financial literacy) and the updated geocentric content of geography education for students of grades 10-11th. a profile level by means of putting into practice the content of the proposed and effectively (positively) tested by the author course «Lean-logistics in geography».

In this context, the ability to independently acquire knowledge is an integral part of competently oriented training aimed at the formation of the key, general subject, geographical competence of applicants for education in institutions of general secondary education.

So, it is necessary and effective process of teaching geography at the profile level of high school students as expedient, systematic and complex process, in which there is the connection of didactic and methodological functions that leads to the competently oriented teaching of geography in high school and is tools for mastering the content of the course «Lean-logistics in geography».

References

1. Concept «New Ukrainian School»: *electronic resource*, access mode: <http://mon.gov.ua>
2. Concept of profile education in high school: *electronic resource*, access mode: <http://osvita.ua/legislation>
3. Concept of realization of state policy in the sphere of reforming of general secondary education «New Ukrainian School» for the period up to 2029: *electronic resource*, access mode: [https://osvita.ua/legislation/ Ser_osv/54258/](https://osvita.ua/legislation/Ser_osv/54258/) (accessed: 12.27.2016).
4. Krykavsky, E. and Chukhray, N. (2004). *Industrial Marketing*, Lviv:Lviv Polytechnic University, 320.
5. Kristopher, M. and Peck, X. (2005). *Marketing Logistics*, Moscow: Technology, 240.
6. Ponomarenko, V. and Tankov, K., and Lepeyko T. (2010). *Logistic management*, Kharkiv: VD INZHEK, 210.
7. State standard of basic and complete general secondary education: *electronic resource*, access mode: [http:// zakon1. rada.gov.ua/laws/show/1392-2011](http://zakon1.rada.gov.ua/laws/show/1392-2011) (accessed: 17.10.2015).
8. Topuzov, O. M. (2017). *Geography: methodological recommendations of the Ministry of education and science of Ukraine*, Kyiv, Orion Center, 88.
9. Topuzov, O. M. (2018). Development of geography as a school subject in the economy of information society. *Scientific and technological revolution of the 21st century 2018*, Karlsruhe-Germany, Published by Sergeieva & Co, 22–25.
10. Udovychenko, I. V. (2018). Conceptual foundations of the content of teaching geography of high school students at the profile level: *monograph*, Kyiv, Pedagogical thought.
11. Udovychenko, I. V. (2018). *Lean-logistics in geography: an elective course curriculum for profile education in grades 11*, Sumy, NVV SOIPPO, 40.

Vasily Chubar*PhD., Associate Professor,**Department of Theories and Techniques of**Technological Preparation of Labor Protection and Health and Safety**Volodymyr Vynnychenko Central Ukrainian State Pedagogical University**Kropivnitsky, Ukraine*

**DIFFERENTIATION AND INDIVIDUALIZATION OF PROFILE TRAINING FOR
HIGH SCHOOL STUDENTS OF TECHNOLOGY**

Abstract. *Research is devoted to the problem of individualization improvement in conditions of internal single-level and multilevel differentiation as the way to realize learner-centered profile training for high school students of technology. Author suggests methodology for defining high school students' cognitive abilities; ways to monitor learning achievements and components' levels of cognitive abilities; approaches to form students groups within the class considering their cognitive abilities; sequence of selecting strategy to implement educational-cognitive process in accordance with high school students' educational achievements and components' levels of their cognitive abilities; approaches to select traditional and modern technologies of learning and educational and methodological support for implementation of educational-cognitive process; adjusting selection of educational technologies, methods, methodical techniques in accordance with monitoring results; list of educational and methodological support for implementation of learner-centered profile training.*

Introduction

Improving profile training for high school students of technology is one of priority tasks of general secondary educational institutions. Its relevance is caused by current socio-economic demands to improve high school students' willingness for professional self-determination, mastering creative personality's abilities for effective work in conditions of innovative production and lifelong learning [14; 17; 22]. This task is under constant attention of Ukrainian and foreign scientists and scholars [6; 7; 12; 20; 21; 23; 24; 28; 29, etc.].

One of the ways of its realization is optimal usage of differentiation and individualization in educational-cognitive process. Their realization is based on technologies of learner-centered education (Yu. Babanskiy [1, p. 21], I. Butuzov [3, p. 18], S. Goncharenko [5, p. 95], A. Zadorozhnyia [6], O. Kirsanov [7, p. 35], O. Savchenko [19, p. 39], G. Selevko [20, p. 86-89], P. Sikorsky [23], I. Sotova [24], I. Unt [27], Uruski [28], A. Tereshchuk [26], O. Shparuk [29], I. Yakimanskaya [31], O. Yaroshenko [32, p. 210] and others). Scientists' researches and scholars' studies (V. Dyachenko, O. Kotikova [9], H. Leimets [10], I. Pervin, O. Pehota, O. Pometun, G. Selevko [20], V. Serikov [21], I. Cheredov, and others) have shown that group learning activities contribute to activation and effectiveness of educational-cognitive process.

Diagnosing methods of various aspects of students' qualities in the process of their profile training have been developed by many scientists. Psycho-diagnostic, psycho-didactic methods have been investigated by V. Dorotyuk, Z. Kalmykova, V. Molyako [11], V. Rybalka [18], L. Turischeva [26] and others. Problem of realization of profile training for high school students of technology at general secondary educational institutions has been studied by O. Kobernyk [8], M. Korets, V. Madzigon, V. Sidorenko [22], V. Steshenko, A. Tereshchuk [25], G. Tereshchuk, V. Titarenko, A. Uruski [28], A. Tsina and others.

While analyzing scientific and methodological literature on profile training, it has been found that there are two most widespread directions of differentiation according to high school students' individual-psychological characteristics: level of mental development and sphere of interests realized when students enter high school [4, p. 415-416]. However, the problem of introducing internal differentiation and individualization, considering high school students' cognitive abilities and professional orientation in the process of profile training for high school students of technology, has not been properly studied.

Analysis of studying and generalizing experience in realization of differentiation and individualization in the process of profile training for high school students of technology suggests that technology teachers use them mostly intuitively, for one reason or another. During lesson planning, educational, educative and developing goals are formulated mostly non-systematically, without considering students' learning achievements and psychophysiological abilities. Among methodological shortcomings we can mention diagnosing methods of students' individual characteristics that are considerable in size and not sufficiently adapted for practical use; lack of time of technology teachers, etc. [11; 18; 26]. Therefore, using individualization and differentiation in the process of profile training of technology will be considered as means of realizing learner-centered education [4; 18, p. 63-64; 20; 24].

1. Diagnosis of high school students' cognitive abilities, learning achievements and formation of their groups

By the term "differentiation of learning" we mean "... form of considering students' individual characteristics during learning process on the basis of their division into specific typological groups by different indicators" [32, p. 210]. Depending on level of differentiation, we distinguish the following types: "... external: selective (rigid) or elective (flexible); internal: single-level or multilevel" [24, p. 157]. By the term "individualization of learning" we mean "... planning and implementation of learning according to students' individual characteristics, ... peculiarities ... perception, thinking, memory, imagination, ... interests, inclinations, abilities, temperament, character" [9, p. 332]. External differentiation is carried out during the process of forming profile classes at high school on the basis of studying high school students' individual characteristics, their inclinations, interests, abilities, psychophysiological abilities, professional intentions, considering local conditions, etc.

Internal differentiation of educational-cognitive process is realized within profile class and "... is based on learning results planning: highlighting the level of compulsory training and forming on this basis higher levels for mastering material. ... Taking into account their abilities, interests and needs, students are given rights and opportunities to choose volume, depth of educational material learning, to vary their workload" [29, p. 157]. It also stimulates creation of permanent or temporary high school students' groups within the class to ensure optimal conditions for implementation of educational-cognitive process to master curriculum, develop abilities, interests, etc. During the process of creating didactic conditions for learning, it is necessary to define, by means of diagnosis and observation, students' interests, their abilities, professional intentions, their psychophysiological abilities, etc. [18; 26, p. 31-88].

Based on study and analysis of scientific and methodological literature, practical work experience at educational institutions, there is reason to claim that effectiveness of educational-cognitive process depends on high school students' cognitive abilities, which are characterized by: learning interest, learning abilities and working capacity during learning process [4; 6; 12; 23; 24].

These indicators are directly related to educational, educative and developing functions of educational-cognitive process and high school students' psychophysiological abilities. The structure of high school students' cognitive abilities is shown in Figure 1.

High school students' cognitive abilities		
Learning interest	Learning abilities	Working capacity during learning process

Fig. 1. Structure of high school students' cognitive abilities

Students can show outlined components of cognitive abilities during educational process at different levels. Based on above mentioned, they should be divided as follows:

- learning interest may be high, medium or low;
- learning abilities may be high, medium or low;
- working capacity during learning process may be high, medium, or low.

Thus, high school students may express specific characteristics of their mental activity during educational-cognitive process, in accordance with levels of components of their inherent cognitive abilities. Brief description how students express these abilities is given below.

Learning interest:

- high level (during educational and cognitive activity processes, on the basis of formed motives for mastering competencies, activity is shown at a high level; control over cognitive activity is not required; students learn educational material without additional motivation);
- medium level (during educational and cognitive activity processes, on the basis of formed motives for mastering competencies, activity is shown at medium level; high school students' cognitive activity requires little control; thanks to educational and educative techniques, attitude to learning is improved for long period);
- low level (during educational and cognitive activity processes, on the basis of formed motives for mastering competencies, activity is shown at low level; students' cognitive activity requires constant control; significant and varied educational and educative effects on results are almost impossible).

Learning abilities:

- high level (during educational and cognitive activity high school student thinks in standard situations perfectly; learns educational material quickly and deliberately without much effort; high school student often finds the right solution in non-standard and problem situations; can master educational material independently and memorize its concrete and abstract components well);
- medium level (during educational and cognitive activity high school student thinks in standard situations well; learns the teaching material satisfactory; sometimes requires additional teacher's explanations; sometimes has difficulties in analyzing facts and summarizing them; he can often be lost in non-standard and problem situations and memorizes educational material mostly consciously);
- low level (during educational and cognitive activity high school student orients himself satisfactorily in standard situations; develops working skills with similar tasks slowly; memorizes educational material superficially, not accurately; learns new educational material weakly and requires additional explanations at lessons as well as out-of-class).

Working capacity during learning process:

– high level (during educational and cognitive activity process student’s overall tone of mental activity, its strength, depth, stability and flexibility of thinking are expressed at high level; student can complete educational tasks actively for a long time and simultaneously shows high level of attention, memory and thinking);

– medium level (during educational and cognitive activity process student’s overall tone of mental activity, its strength, depth, stability and flexibility of thinking are expressed at medium level; high school student can complete educational tasks actively not for a long time and simultaneously shows sufficient level of attention, memory and thinking);

– low level (during educational and cognitive activity process student’s overall tone of mental activity, its strength, depth, stability and flexibility of thinking are expressed at low level; completing educational tasks high school student shows slowness, passivity; attention, memory and thinking are expressed at low level).

To define possible combinations of components of high school students’ inherent cognitive abilities, considering their level, let’s mark them by letters: learning interest – I, learning ability – A, working capacity during learning process – W, and levels of formation let’s mark by numbers: high – 1, medium – 2, low – 3. As a result of components’ combinations, there are 27 possible variants of high school students’ specific cognitive abilities. To facilitate their practical usage, we have developed matrix of components’ combinations of cognitive abilities, taking into consideration their levels (Table 1).

Table 1. Matrix of components’ combinations of cognitive abilities, taking into consideration their levels

№ п/п	<i>I</i>	<i>II</i>	<i>III</i>
<i>1</i>	I - 1; A - 1; W - 1	I - 1; A - 1; W - 2	I - 1; A - 1; W - 3
<i>2</i>	I - 2; A - 1; W - 1	I - 2; A - 1; W - 2	I - 2; A - 1; W - 3
<i>3</i>	I - 3; A - 1; W - 1	I - 3; A - 1; W - 2,	I - 3; A - 1; W - 3
<i>4</i>	I - 1; A - 2; W - 1,	I - 1; A - 2; W - 2	I - 1; A - 2; W - 3
<i>5</i>	I - 2; A - 2; W - 1	I - 2; A - 2; W - 2	W - 3, A - 2, I - 2
<i>6</i>	I - 3; A - 2; W - 1	I - 3; A - 2 W - 2	I - 3; A - 2; W - 3
<i>7</i>	I - 1; A - 3; W - 1	I - 1; A - 3; W - 2	I - 1; A - 3; W - 3
<i>8</i>	I - 2; A - 3 W - 1	I - 2; A - 3; W - 2	I - 2; A - 3; W - 3
<i>9</i>	I - 3; A - 3; W - 1	I - 3; A - 3; W - 2	I - 3; A - 3; W - 3

Diagnostics of high school students’ cognitive abilities, as well as their learning achievements was carried out according to methodology developed by the author:

- observing students’ cognitive activity at lessons and out-of-class;
- specially selected situations that have been realized during educational process in the form of different tasks, individual work or tests, etc.;
- individual interviews, which provided direct and indirect questions about motivation and purpose of learning;
- questionnaire about students’ attitude to learning;
- analysis of learning achievements, i.e. performance indicators, as well as lessons attendance.

Diagnostics results of learning achievements and components of cognitive abilities are recorded in Table 2.

Table 2. Diagnostics results of learning achievements and high school students' cognitive abilities

№	Student's name and surname	1, 2, 3, 4 – diagnostics results															
		Learning achievements				Learning interest				Learning abilities				Working capacity during learning process			
		1	2	3	4	1	2	3	4	1	2	3	4	1	2	3	4
1.																	
2.																	

Data, obtained from comparative analysis of diagnostics results of high school students' achievements in profile training (Table 2) and components' combinations of cognitive abilities (Table 1), allow making conclusion that high school students' learning achievements level [13] depends on components' combinations of students' specific cognitive abilities in the following way:

– such components' combinations of cognitive abilities correspond to high learning achievements – (1. I); (2. I); (4. I); (1. II);

– the following components' combinations of cognitive abilities correspond to sufficient learning achievements – (3. I), (5. I), (7. I), (2. II), (4. II), (1. III);

– such components' combinations of cognitive abilities correspond to medium learning achievements – (6. I), (8. I), (9. I), (3. II), (5. II), (6. II), (7. II), (8. II), (2. III), (3. III), (4. III), (5. III), (6. III);

– the following components' combinations of cognitive abilities correspond to elementary learning achievements – (9. II), (7. III), (8. III), (9. III).

According to diagnostics results of learning achievements (Table 2) we have formed statistical series of frequency of grades obtained by high school students for learning achievements (Table 3).

Table 3. Frequency of grades obtained by high school students for learning achievements

x - grades	1	2	3	4	5	6	7	8	9	10	11	12
y - frequency												

In addition, according to diagnostics results of high school students' learning achievements (Table 2), we have constructed a histogram of frequency of grades obtained by high school students for elementary achievements expressed in percentage (Fig. 2).

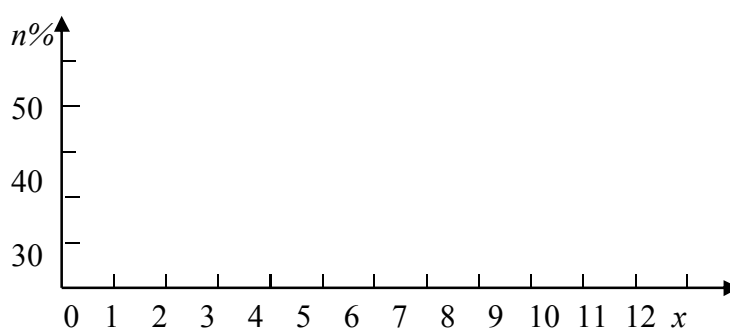
**Fig. 2. Classification of grades for learning achievements within a class, in percentage**

(x – students' grades for learning achievements; n – number of students, who obtained the same grades, in percentage).

Similarly, we have formed statistical series of frequency levels of each component of cognitive abilities, and constructed histograms of distribution of high school students' inherent levels of components of cognitive abilities in percentage. Obtained results made it possible to define the state of students' elementary achievements and cognitive abilities within the class.

To realize internal single-level and multilevel differentiation of educational-cognitive process, three-to-six-student groups have been formed, which are characterized by:

- components' combinations of cognitive abilities that provided elementary learning achievements;
- components' combinations of cognitive abilities that provided medium learning achievements;
- components' combinations of cognitive abilities that provided high and sufficient learning achievements;
- components' combinations of cognitive abilities that provided different learning achievements (high, sufficient, medium and elementary).

Observations have shown that six-student groups were not effective. Groups consisting of students having components' combinations of cognitive abilities, that provided them with high or sufficient learning achievements [13], often were divided into smaller ones. One student, having such level of cognitive abilities in a group, appeared not to have time completing educational tasks optimally and helping other members of his group.

Technology teacher had to prepare tasks of different complexity for each group, consisting of students having components' combinations of cognitive abilities, that provided them with the same learning achievements (high, sufficient, medium, or elementary). This is due to the fact that students with high and sufficient learning achievements, as a rule, completed given tasks quickly, and were not interested in similar-type tasks offered for students with medium and elementary learning achievements. When students were offered specially prepared tasks, effectiveness of their cognitive activity was increased greatly. In general, this approach for group formation has not increased cognitive ability of high school students having medium and elementary learning achievements levels. Four-student groups consisting of students having different components' combinations of cognitive abilities worked quite productively. All high school students worked together to complete educational tasks. Students with high and sufficient learning achievements spent part of their free time helping students with secondary and elementary learning achievements. This approach helped to improve their competences and develop cognitive abilities (*docendo discimus*). Based on study of scientific and methodological literature on group formation for educational-cognitive process realization and conducted research, we offer to form groups of profile training for high school students of technology in conditions of internal single-level and multilevel differentiation according to the following requirements:

- depending on educational-cognitive process tasks, educational groups may be formed from high school students having components of cognitive abilities with different or equal levels;
- educational group consists of 4 high school students, who have places close to each other to ensure constant contact (this number of students enables pair-work);
- group leaders are selected from high school students having high-level components of cognitive abilities, and in some cases, those who have medium cognitive abilities and organizational skills;
- when forming a group, it is necessary to take into account attitude of students to each other and not to involve in one group students having dislike, antipathy, etc.;

- high school students with organizational skills should be involved in different groups, which will optimize educational and cognitive activity of the whole class;
- group members might be changed during school year, i.e. students are allowed to move from one group to another, if it is caused by necessity to activate their cognitive activity;
- students having problems with behaviour should be put into groups, whose members have stable character traits or, at least, should not be grouped at all and have separate tasks.

2. Profile training for high school students of technology in conditions of internal single-level and multilevel differentiation

Educational-cognitive process is considered as two-way process of interconnected technology teacher's activity in teaching, organizing and managing high school students' cognitive activity on the one hand, and high school students' cognitive activity aimed at mastering competencies in chosen subjects, specialization or profession on the other hand [2, p. 745]. On the basis of above mentioned, we have constructed structural and functional scheme of educational-cognitive process of profile training for high school students of technology (Fig. 3). The scheme identifies flows of information according to which technology teacher makes decisions for educational-cognitive process management:

- social order (Laws on education, Presidential decrees, State standard of basic and complete general secondary education and normative documents of Ministry of Education and Science of Ukraine on profile training for high school students of technology, etc.);
- information about students' learning achievements and their cognitive abilities.

Structural and functional scheme identifies direct and backflows of information that function during implementation of educational-cognitive process in conditions of internal single-level and multilevel differentiation:

- technology teacher – students' groups, individual group – technology teacher;
- technology teacher – educational and methodological support – students' groups, individual group – technology teacher;
- students' groups, individual group – educational and methodological support (independent or interactive cognitive activity inside individual group of students under technology teacher's management).

Information flows from technology teacher to students and information backflows, which are indicated at structural and functional scheme (Fig.3), consider important characteristics of educational-cognitive process as closed dynamic system. Important role in improving its functional effectiveness is played by systematic monitoring of backflows, in particular, high school students' learning achievements and components' levels of their inherent cognitive abilities (Table 1). Their periodic fixation (Table 2) has contributed to information support of educational-cognitive process management, made it logical and consistent. Technology teacher analyzed information obtained during monitoring process and formulated didactic strategy for implementing profile training for high school students of technology. According to this strategy, lesson plans indicated educational, educative and developing goal of each lesson. To implement them on the basis of monitoring results (Table 2), a reasonable decision was made regarding optimal choice of numerous educational technologies, methods, methodical techniques and educational and methodological support, which guaranteed their effective implementation. Therefore, realization of educational-cognitive process goal is not intuitive, but methodically justified.

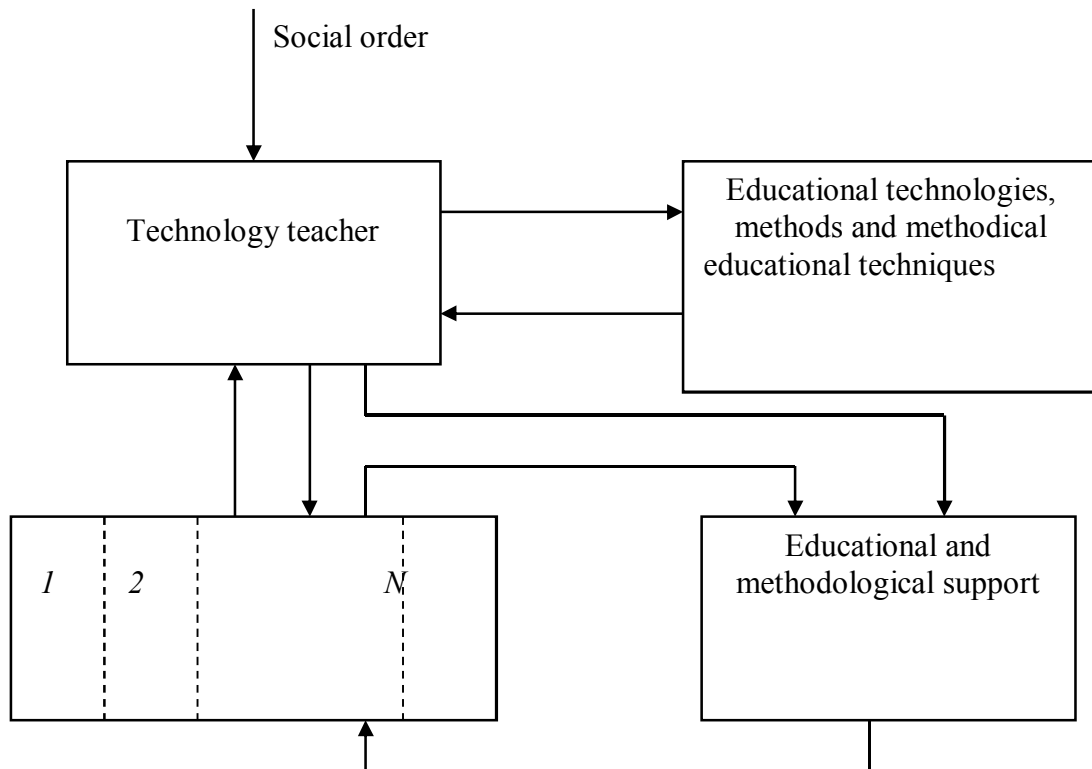

Fig. 3. Structural and functional scheme of educational-cognitive process
 1, 2, ... N – groups of students formed within a class.

Organization of profile training for high school students of technology, considering their cognitive abilities in conditions of internal single-level and multilevel differentiation, it is necessary to carry out as follows:

- in academic groups with students' cooperation united by common educational goal with indirect technology teacher tutoring [3; 7; 8; 12; 25; 29, etc.];
- by selection of methods, methodical techniques, pedagogical technologies and educational and methodological support of educational-cognitive process, which give possibility to interconnect educational, educative and developing lessons functions, i.e., stimulate development of learning interest, learning abilities and working capacity during learning process [4; 19; 20; 21; 23];
- realization of motivational, educational, developing and educative lessons functions [4, p. 284-285; 30, p. 241-243] to form students' creative, innovative attitude for future working activity, because employee of any industry will always be accompanied by ability to analyze, have creative approach for working and technological process organization, desire to seek and find ways and means of improving productivity;
- increasing management effectiveness of educational-cognitive process by monitoring learning achievements and components' levels of cognitive abilities and, according to the results of its analysis, adjusting choice of methods, methodical techniques, training technologies and educational and methodological support [13].

Individualization of profile training for high school students of technology in conditions of internal single-level and multilevel differentiation is recommended to carry out by:

- consistent implementation of educational, educative and developing functions of educational-cognitive process, which accordingly with state program, make students solve cognitive problems in different ways [4; 15; 16; 17; 30, etc.].

- orientation of educational-cognitive process on development of high school students' cognitive abilities, which will help to increase their learning achievements level;

- taking into account professional intentions, cognitive abilities and educational-cognitive process direction to identify and develop students' potential opportunities, interests, abilities and working capacity.

Educational process in conditions of internal single-level and multilevel differentiation should be carried out through mutual learning. Technology teachers need to provide high school students with optimal conditions for their cognitive process, using numerous collaboration forms. In one case, teacher and students are equal participants of cognitive process, in the other – tutor and subordinates, in the third – author and assistants, etc. The following requirements should be observed when organizing mutual education of high school students in their groups:

- to carry out cognitive process under direct teacher's management;

- during educational process teacher has to pay attention to the most important and complicated issues and provide appropriate students' assistance if necessary;

- to conduct careful monitoring of cognitive process quality in groups where group leaders are not sufficiently trained;

- at the beginning of the lesson teacher should personally check quality of most students' competences, and then – of some individual students;

- during educational-cognitive process teacher should keep under special control quality of weakly-trained students' competences.

Educational process in conditions of internal single-level and multilevel differentiation is carried out by mutual cooperation of teachers and students. Technology teacher's success is determined by his or her pedagogical skills in managing high school students' cognitive activity by using different educational technologies, methods and didactic techniques. Therefore, it is necessary to use such methods and technologies that enable organization of collective cognitive activity aimed at forming students' competences on the basis of actualizing available information, using their own experience, comparing, analyzing and synthesizing studied facts and phenomena, as well as conclusions and generalizations. Appropriate state of activation of cognitive activity can be achieved provided that learning will be logical and consistent process. At the same time, increased interest in technologies, phenomena, technological equipment and processes should provide creative situations, activate high school students to search for unknown facts and unusual solutions. It is appropriate to create suitable conditions for further development of components' levels of cognitive ability through the choice of methods, didactic techniques, educational technologies and educational and methodological support.

In process of individualization of profile training for high school students of technology in conditions of internal single-level and multilevel differentiation, it should be taken into account that educational-cognitive process in high school forms is at higher level than in previous forms. Educational material is more complicated; requirements for acquired competences, self-study, activity and cause and effect explanation of phenomena and processes are increased. At the same time, qualitative changes of high school students' cognitive abilities are observed: attention becomes more concentrated; perception of educational material – deeper, more thorough and based

on previous experience, knowledge and intellectual potential; role of conscious remembering increases; logical and theoretical thinking develops and activates; ability to give reasons for their opinion is formed; creative imagination is developed, etc.

Individual approach to profile training for high school students of technology in conditions of internal single-level and multilevel differentiation methodically is appropriate to organize by optimal using of traditional and innovative educational methods and appropriate educational and methodological support during educational process. Choice should be made taking into account results of monitoring learning achievements and components' levels of cognitive ability (Table 2). Range of educational methods and technologies is wide and there are no universal methods. Technology teachers should consider the following indicators when choosing didactic methods and techniques:

- level of their theoretical training, methodical skills and practical experience;
- certain class students' cognitive abilities;
- level of students' learning achievements;
- level of development of interpersonal relationships in training groups;
- content and volume of studied material;
- state of educational and methodological support, etc.

In order to increase effectiveness of educational-cognitive process in conditions of internal single-level and multilevel differentiation, it is appropriate to recommend a combination of different educational methods, in particular, traditional and innovative, verbal and visual, verbal and practical, verbal, visual and practical, etc. When applying them it is necessary to be guided by the fact that:

- verbal methods include: retelling, explanation, message, lecture, conversation, consultation, etc.;
- visual methods - demonstration of posters, tables, models, experiments, technological operations, technological equipment, etc.;
- practical methods - implementation of projects, implementation of technological operations, practical tasks, self-study with textbooks, etc.;
- innovative - active and interactive technologies (“work in pairs”, “microphone”, “brainstorming”, etc.), as well as their combination depending on educational process tasks [4, p. 320-363; 30, p. 317-350].

In process of profile education for high school students of technology in conditions of internal single-level and multilevel differentiation, it is important to introduce tasks of educational projects implementation. While working on the project, it is recommended to use individual approach to high school students, to provide it considering level of program material or product complexity and originality, necessary amount of information, independently or with the help of the teacher introducing elements of novelty in the project, choosing its design and decoration, material support, practical work, etc. Methodologically justified is the use of creative projects, implementation of which involves combination of design process (use of creative methods) according to certain scheme and designed product production (application of practical educational methods) [8, p. 45-46; 20; 21; 22; 23]. Implementation of educational projects of various complexity, including creative ones, will contribute to:

- development of cognitive capacities and proper mastery of curriculum;

- formation of high school students' readiness for further learning of theoretical and practical components of curriculum;
- improving skills in research, technical construction, design creativity, etc.;
- development of personal qualities.

Educational discipline "Technology" differs from other general disciplines as it combines theoretical and practical components of educational-cognitive process, but practical part is the main one. In context of internal single-level and multilevel differentiation doing practical tasks, the following steps should be observed: receiving tasks from teacher by high school students; analysis of proposed tasks; sequence of tasks implementation; analysis of results of performed work, identification of shortcomings and their elimination; presentation of the product. It should be noted that during completing tasks, teachers should create conditions for applying individual approach to profile training for high school students of technology. Students should be offered different content tasks: simple, i.e. training, complicated or original. This method of project work organization intensifies process of cognition, promotes thorough assimilation of educational material provided by curriculum for high school students. At the same time, students with high levels of cognitive ability will be able to go beyond the program and show their individual abilities [12, p. 38-39].

Using information technologies in conditions of internal single-level and multilevel differentiation of profile training for high school students of technology methodically motivated are: discussions, seminars, "work in pairs", "microphone", "brainstorming", etc., as well as their combination depending on tasks and goals of educational process [4; 8, p. 99-100; 30, p. 371-383]. Thus, the following sequence should be followed by:

- formulation of task for training groups;
- appointment of experts, whose responsibility is evaluation and selection of best ideas, options offered by students' teams of study groups;
- fulfillment of task by training groups;
- discussing and summarizing the work and making collective decision.

In process of implementing individual approach to profile training for high school students of technology in conditions of internal single-level and multilevel differentiation, it is methodically appropriate to use educational and methodological support that will perform not only informational but also motivational and developmental functions, in particular:

- textbooks and tutorials, task cards, instructions for sequence of implementation of projects of various complexity;
- samples of design and technological documentation for products manufacturing (working parts drawings, assembly products drawings, technological maps for products manufacturing with complete and incomplete data, design tasks, etc.);
- layouts, models of technical devices and mechanisms, natural objects, components of products, details, various constructions of detachable and non-detachable connections, analog products, etc.;
- computers at development of new program material, self-study of specific issues and control tasks, finding information for project implementation, etc.
- instructions for applying creative methods of inventive tasks, in particular: focal object method, brainstorming method, etc., for designing products, formulating suggestions for their improvement or introducing novelty elements;

– samples of products with quality design to improve products design in the process of creative projects.

Checking of high school students' learning achievements in process of profile training of technology in conditions of internal single-level and multilevel differentiation has considerable possibilities for implementation of individual approach requirements [8, p. 103-105; thirteen; 30, p. 412-414]. We propose to implement it through using educational tasks with different levels of complexity for preliminary, current, periodic and final control of learning achievements.

Insufficient levels of some high school students' learning achievements that were identified during checking process can be improved through individual, group and collective consultations, tasks for processing additional sources of information, selection of special tasks, etc. Methodically motivated are different forms of individual work, such as: self-study of educational material; preparation of answers to control questions; performing additional practical work; independent manufacturing of products, etc. This approach stimulates high school students' interest in technology learning, enhances their competencies, cognitive abilities and enhances learning outcomes.

Conclusions

Proposed approach to improve implementation of individualization of profile training for high school students of technology in conditions of internal single-level and multilevel differentiation of educational-cognitive process makes it possible:

– defining high school students' cognitive abilities in accordance with proposed methodology;

– forming groups of students within the class, taking into account their cognitive abilities;

– defining strategy for selection of methods, didactic techniques, educational technologies and educational and methodological support according to the state of high school students' learning achievements and components' levels of their cognitive abilities;

– it is logically and methodologically justified to apply traditional and modern technologies of education, educational and methodological support and modern information and communication technologies in accordance with selected strategy of training methodology during educational-cognitive process;

– monitoring of learning achievements and components' levels of cognitive abilities and, according to results of their analysis, to adjust selection of methods, didactic techniques, educational technologies, as well as educational and methodological support to increase leadership effectiveness of educational-cognitive process.

This study does not cover all issues of the problem of individualization of profile training for high school students of technology in conditions of internal single-level and multilevel differentiation of educational-cognitive process.

It is advisable to direct further work on the outlined problem to:

– content substantiation of the concept “cognitive abilities”, defining its components and clarification of their levels;

– improvement of diagnostics method of cognitive abilities in process of implementation of profile training;

- improving process of formation of high school students' groups with different levels of cognitive abilities for implementation of single-level and multilevel internal differentiation and individualization;
- development of educational and methodological support for implementation of differentiation and individualization of profile training for high school students of technology defined by educational curricula [15; 16];
- working out methodology for diagnosing special high school students' competencies formed in process of mastering selected technologies.

References

1. Babanskii, Ju.K. (1977). *Training process optimization: all-didactic aspect*. Moscow: Pedagogika [in Russian].
2. Bondar, V.I. (2008). Training process. *Encyclopedia osvity APN Ukrainy – Encyclopedia of formation of NPA Ukraine*. Kyiv: Yurinkom Inter [in Ukrainian].
3. Butuzov, I.D. (1968). *Differentiated education is an important didactic tool for the effective education of schoolchildren*. Moscow: Pedagogika [in Russian].
4. Volkova, N.P. (2009). *Pedagogics: navch. posib. The 3rd edition, stereotypic*. Kyiv: Akademydav [in Ukrainian].
5. Ghoncharenko, S.U. (1997). *Ukrainian pedagogical dictionary*. Kyiv: Lybidj [in Ukrainian].
6. Zahorodnia, A.A. (2018). Features of differentiation of content of training in high school. Current problems of higher education of Ukraine: Materials VI of the International scientific and practical conference. (pp. 62-64). Kyiv [in Ukrainian].
7. Kirsanov, A. (1980). *Individualization of school activities*. Kazan [in Russian].
8. Kobernyk O.M., Brbets V.V., & Dubova N.V. et al. (2010). Labor training at school: projektno technological activity 5-12 classes. O.M Kobernyk (Ed). Kharkiv: Osnova [in Ukrainian].
9. Kotykova, O.M. (2008). IT raining individualization. *Encyclopedia osvity APN Ukrainy – Encyclopedia of formation of NPA Ukraine*. Kyiv [in Ukrainian].
10. Liimets, X.Y. (1975). *Group Work in Lesson*. Moscow: Znanie [in Russian].
11. Molyako, V.A. (Eds). (2008). *Psychological research of creative potential of the personality*. Kyiv: Pedahohichna dumka [in Ukrainian].
12. Nazarenko, N. (2010). Development of creative abilities and self-checking in the course of group implementation of educational projects on cookery. *Trudova pidhotovka v zakladakh osvity – Labour preparation in education institutions. 11-12, 36-39*. [in Ukrainian].
13. Order MON of may 05, 2008 N 371 «The general criteria of estimation of educational achievements of pupils in the system of the general secondary education. osvita.ua/school/estimation. Retrieved from <http://osvita.ua/school/estimation/2358/>
14. Order Department of education and science from october 21. 2013h № 1456. «The concept of profile training in high school». *Trudova pidhotovka v suchasnyy shkoli – Labor preparation at modern school, 10, 2-10*. [in Ukrainian].
15. Order of the Ministry of Education and Science of Ukraine No 1407 of October 23 2017. Technologies. The training program from technologies (standard level) for 10-11 classes of comprehensive schools. *Trudova pidhotovka v ridnyy shkoli – Labour preparation at native school, 4, 2 - 13*. [in Ukrainian].

16. Order of the Ministry of Education and Science of Ukraine No 1407 of October 23 2017. Technologies. The training program from technologies (standard level) for 10-11 classes of comprehensive schools. *osvita.ua/school*. Retrieved from <https://osvita.ua/school/program/program - 10-11/58970/> [in Ukrainian].
17. State standard of basic and full general secondary education. Resolution of Cabinet of Ministers of Ukraine from November, 23 of 2011h № 1392. *zakon4.rada.gov.ua*. Retrieved from <http://zakon4.rada.gov.ua/laws/show/1392-2011-p> [in Ukrainian].
18. Rybalka, V.V. (1998). *Personal approach in profile training of senior*. Kyiv: IPPPO APN Ukrainy [in Ukrainian].
19. Savchenko, O.Ia. (1997). Differentiation of training at all stages of a lesson. *Savchenko, O.Ia. Suchasnyi urok u pochatkovykh klasakh*. Kyiv: Mahistr-S [in Ukrainian].
20. Selevko, G.K. (1998). *Modern educational technologies: studies. grant*. Moscow: Narodnoe obrazovanie [in Russian].
21. Serikov, V.V. (1998). *Personality-oriented education: finding a new paradigm*. Moscow: Pedagogika [in Russian].
22. Sydorenko, V.K. (2010). The impact of social and economic processes in society on definition of approaches to labor training of school students. *Trudova pidhotovka v zakladakh osvity – Labour preparation in education institutions*. 7-8, 3-8. [in Ukrainian].
23. Sikorskyi, P.I. (2001). The theory and technique of the differentiated training in average general education and professional educational institutions. *Extended abstract of Doctor's thesis*. Kyiv [in Ukrainian].
24. Sotova, I.A., & Parfenova, E.L. (2013). Differentiation as a way of realization of personally focused training at modern school. *Journal of the Orenburg State Pedagogical University*, 3 (7), 155-160. [in Russian].
25. Tereshchuk, A. (2010). The differentiated training as the leading way of modernization of modern education. *Labour preparation in education institutions*, 4, 26-29. [in Ukrainian].
26. Turishcheva, L.V. (2007). *Psychological maintenance of profile training*. Kharkiv: Osnova [in Ukrainian].
27. Unt, I.Je. (1990). Individualization and differentiation of training. Moscow: Pedagogika [in Russian].
28. Uruskyi, A.V. (2016). Model of a technique of individual approach to training of seniors for technological to a profile. *Scientific notes of the Ternopil national pedagogical university of Vladimir Hnatiuk*. Ternopil: TNPU [in Ukrainian].
29. Shparyk, O.N. (2015) A problem of differentiation of training in researches of the Ukrainian scientists and scientists of the neighboring countries. *Ukrainskyi pedahohichnyi zhurnal – Ukrainian pedagogical magazine*. 4, 152-164. [in Ukrainian].
30. Yagupov, V.V. (2002). *Pedagogics: manual*. Kyiv: Lybid. [in Ukrainian].
31. Yakimanskaiia, I.S. (1996). *Personal-oriented education in modern school*. Moscow: Sentiaber [in Russian].
32. Yaroshenko, O. (2008). Training differentiation. *Encyclopedia osvity APN Ukrainy – Encyclopedia of formation of NPA Ukraine*. V.G. Kremen (Ed). Kyiv: Yurinkom Inter [in Ukrainian].

Oleksiy Stupnytskyy*Ph. D. in Economics, Professor**Institute of International Relations**Taras Shevchenko National University of Kyiv**Kyiv, Ukraine***NEW TECHNOLOGICAL ORDER AND CHANGE OF EDUCATIONAL PARADIGM**

Abstract. *The article analyzes social transformations of the labour market, which is the most sensitive indicator of changes occurring in a market economy, and undergoes significant transformation under the influence of digitalization and introduction of information and communication technologies (ICT) in various fields of activity of firms and specific individuals. The article classifies flexible and adaptive models of workforce employment in the context of changing target imperatives of businesses, as well as social effects characteristic of the dynamic stage of ICT development and necessary for the 'post-industrial' model of education. The perspective and relevant skills of the labor market related to technological acceleration of Industry 4.0, as well as the main reasons for the low impact of educational technologies on the rate of change of the dominant educational paradigm are highlighted. The key factors of educational innovations that serve the development of students' independent orientation are analyzed. The main tasks for educational ecosystem to facilitate the transition to global learning platforms are identified*

Introduction

In the context of accelerating globalization processes and the emergence of a new technological structure, education, as the most complex social technology of social transformation, is turning into a means of overcoming growing digital gaps and imbalances in information flows, growing socioeconomic inequalities, and growing environmental problems. Nevertheless, the existing educational systems are still designed for the world of the past. They require changes in approaches and models of training, rethinking of their goals and design based on human values, and transformation of the educational paradigm itself that meets the requirements of the future. The scientific community has not yet formed an unambiguous point of view on the nature of the impact of digitalization on the workforce. It can be confidently stated that workers will need new professional skills and competencies for successful functioning in the digital economy in the near future. A number of administrators and teachers often resist changes in the educational landscape, although teaching methods based on the students' interests and preferences, gamification of instruction, project design of the teaching-learning process, creativity and mega-skills are quite an effective tool.

1 Social Transformations of Industry 4.0 and Educational Ecosystems

Today, the effects of Industry 4.0 technological acceleration are most noticeable in the fields of ICT or the so-called exponential technologies, such as digital technologies (DT), bio- and nanotechnologies, artificial intelligence technologies (AIT) which mutually reinforce each other. The main sources of these effects are: a) 'social' facilities of knowledge and innovation creation (research and entrepreneurial universities, corporate technology departments, technical and regional innovation ecosystems) that create a steady stream of new technologies; b) 'network' technologies which become a means of rapid spread of digitalization; c) globalization institutions which gradually evolve from free trade agreements supporting capital and export flows, to global standardization of technology, professional requirements and educational processes. They will be the most powerful and immediate driving forces of socio-economic changes through the following processes:

Firstly, **digitalization**, which significantly changes the structure of demand in the labour market – along with the spread of ICT, it becomes critical from the of employers’ viewpoint. Requirements for specialists are changing at a large-scale, since many operations not affected by previous waves of digital technology introduction can be automated in the near future. The ability to work with large amounts of structured and unstructured information allows companies to improve the quality of demand forecasting, to optimize production processes, service offers, etc. The introduction of digital technology leads to significant changes in staff demand and requirements for specialists, which are expressed in the following:

- shorter life cycle of professions due to rapid change of technology and emergence of new roles and professions;
- formation of new competency profiles for a number of categories of personnel (risk analytics, HR managers, marketing analysts, contact centre operators, etc.) connected to changing work tools;
- increasing requirements for staff flexibility and adaptability, especially for soft skills – possession of socio-emotional intelligence (the abilities that distinguish a human from a machine);
- reduced demand for jobs related to formalized repetitive operations and increased demand for professionals with *digital dexterity* – the ability and desire to use new technologies to improve business results.

According to McKinsey’s calculations, today already about 30% of the functions within existing professions can be automated based on the current level of ICT development [1], and the probability that due to digitalization and implementation of TII such professions as a bank operator, auditor, loan specialist 2027, just disappear is 98% [2; 3].

Secondly, automated jobs with the help of AIT, thanks to which global GDP growth will be about 9 trillion US dollars and 375 million workers (about 14% of the world workforce) will be forced to change their professions by 2030 [4]. Cognitive routine tasks, both in manual and in intellectual labour (marketing, finance, communications, etc.), can be replaced by AIT and robotics. In addition, technologies, such as 3D printing and biotechnology, can destroy entire industries and supply chains replacing the conveyor-type mass-production economy with adaptive regenerative production networks. Such shifts in employment and organization of production, as evidenced by economic history, have never occurred at such a pace – in less than one generation. With the growth of automation, there has always been a growing demand for creation of new sectors where labour market entities migrated. However, there are currently at least five sectors where significant growth in jobs and new types of human activities can occur:

1. *‘New’ next-generation technological sectors* for industrial and consumer applications (smart energy networks, urban robotics, unmanned autonomous vehicles, renewable bioengineering materials, etc.).
2. *Virtual economy of social networks*, which allows us to: overcome almost any restrictions that exist in physical reality; create ‘design rules’ that may be impossible or implausible in the ‘real’ world; to have indefinite professions as developers, simulators, or players in simulations.
3. *An eco-regenerative economy* that aims to create ‘green jobs’ and helps to protect and develop global natural ecosystems (*bio-ecosystem production of food, energy and materials*).

Third, transformation of social institutions Introduction of DT will allow not only the use of systems with the ability to recognize and modify themselves (*strong* artificial intelligence) [5], but also ‘interpreted artificial intelligence’ which are able to provide feedback and explain to users the logic of decision-making, which is especially important in areas such as healthcare, security, law,

etc. [6; 7]. However, the modern transformation of social institutions is taking place in conditions of economic and environmental instability, uncertainty, complexity and ambiguity of technological shifts, and elimination of artificial boundaries on labour and capital markets. This changes the functions and forms of their activities in the context of management and finance systems combining collective intelligence to solve both local and global problems.

Fourth, demographic shifts associated with increased average life expectancy. If current trends continue, it will increase up to 100 years in the industrialized countries of the OECD by the middle of the 21st century, which will allow the majority of the population to lead an active life of at least 90 years, on the one hand. On the other hand, it will lead to reduction in the birth rate and decrease in the share of young people in the population structure, which will create demand for new approaches to education and new competencies. Now in the era of Industry 4.0, new materials, biotechnology and renewable energy, where DT and AIT, robotics, and 3D printing are widely used, have a huge impact on changing the nature of training and work.

The changing global landscape of work and lifestyle is generating massive demand for new individual and collective skills, and knowledge is becoming collectively constructed. In these conditions, *soft skills* (cooperation, communication, and creative thinking) are increasingly necessary for employment and successful career building, professional growth and satisfaction with performance. Expansion of new global technological, financial and environmental standards is dramatically changing employees' professional participation in globally diversified organizations and communities, where implementation of creative joint work in the environment of the DT meets their personal and more significant social goals, and lifelong learning is inevitable. 'Future skills' that make workers more strategically competent in the expected socio-economic and technological conditions include:

a) various *complex* skills and knowledge associated with changes in technology and operating conditions;

b) *soft skills* and general knowledge that can be applied in various professional, social and personal contexts, such as:

- skills and knowledge that help to cope with fundamental uncertainty/ambiguity of processes and phenomena – cooperation, creativity, entrepreneurial skills, ability to cope with stress, and ability to understand and/or accept various future scenarios and create appropriate individual and collective action strategies;

- skills and knowledge that help to cope with the growing complexity and interdependence of processes and phenomena – systemic thinking, non-standard problem solving and thinking oriented to opportunities;

- skills and knowledge which include basic programming, ICT and information retrieval, its processing and analysis, media literacy, the ability to direct and focus attention;

- skills and knowledge to determine “what machines cannot do” including empathy (emotional, physical and naturalistic intelligence), as well as the ability to work creatively together;

- skills and knowledge related to achieving focused interdisciplinarity and mastering knowledge in many areas of activity.

Existential skills that can be universally applied throughout life and in different situational contexts and include the following abilities are also of great importance in modern ICT and DT, and include the following abilities: to establish and achieve goals (willpower); learn / wean / re-learn (self-development); self-awareness / self-reflection (mindfulness). When classifying *soft skills*, one should take into account, firstly, their division into context-specific skills (using special tools, for example, surgical skills), cross-contextual skills (for example, time management, teamwork) and meta-skills

(‘modality’ of intelligence – various ways of controlling objects mentally and realistically). Secondly, these skills have different life cycles: context-specific skills are formed during short learning cycles, cross-contextual skills take years or even decades — longer training periods, and meta-skills have the longest life cycle – they usually develop at earlier stages of human life and rarely change subsequently.

At present, the ‘industrial’ model of education (the ‘assembly line’ for training mass workforce to use qualification skills in industrial production) no longer corresponds to the current stage of the XXI century socio-economic environment, although the degree to which the traditional educational systems worsen labour market potential is often underestimated. Unfortunately, miscalculations in the educational process are explained by various failures in competence (managerial, engineering or software skills) and the lack of potential to meet current needs, and not by the need to change the paradigm of educational systems. When analyzing the conformity of the educational goals (formation of certain skills and knowledge) with the educational means (processes, methodologies, skills and views of teachers), the following becomes apparent: firstly, present-day educational models have flaws in their very structure – they are focused on the circumstances of the past: social obedience, work with the low creativity level, standard work processes, competitive work environment, but not the tasks and challenges of the future. Secondly, there are no adequate estimates of the global skill gap that would take into account all the expected shifts, emerging needs of the labour market and new (transforming) sectors of the economy. This is connected with both industry changes caused by new technologies, and the increasing flexibility of the workforce.

Among jobs which are highly likely to be fully automated and replaced by robotic or software solutions and associated with performance of formalized repetitive operations, are primarily subject to disappearance on the labour market today. In the future, workers performing simple mental operations will be involved only in non-standard situations that AIT could not cope with. So, according to experts' forecasts, the development of ICT is able to free 12.5 million employees [8], while 40-50% of work expressed in man-hours will be automated by 2036, and this figure may amount to 80-99% by 2066 [9]. According to another study, more than 50% of the existing jobs (professions) (that is, more than 2 billion jobs) will be significantly changed and technically outdated in the global economy by 2030 [10]. Although big countries of the world, from the USA and Germany to China and India, consider next-generation ICTs to be the main scientific and technological priority, about 90% of companies say that their employees do not have sufficient skills for the digitalization stage. One way or another, the introduction of new training methods and curricula for the next wave of Industry 4.0 should cover at least 20-50% of the staff in developed OECD countries within the next decade [11].

Today, a rapid increase in demand for specialists in the field of big data (data scientists), who are able to structure information and extract value added from it, is expected in all sectors of the economy. Their key competencies in demand include: deep understanding of mathematical statistics and probability theory, analytical abilities, skills for solving non-standard problems, effective work result presentation skills, curiosity and aptitude for working with data. The profession of ‘data researcher’ is becoming intersectoral and in the face of fierce competition, its skills will have to be mastered by a wide range of corporate specialists. In addition, as labour markets are rapidly moving towards more flexible and adaptive employment models, more and more workers will be responsible for their own employment and skills development. According to the survey, more than 50% of US industrial companies rated AIT as a critical element of competitiveness over the next five years, and more than 40% of the US workforce will become ‘random’ or freelance [12]. Since the USA is a ‘trendsetter’ for developed and developing countries in many respects, this structure of

employment is expected to spread quite widely within the global economy in the next 10-15 years. This means that the introduction of new job-related skills will affect at least $\frac{1}{2}$ of the workforce of OECD countries over the next decade.

The development of neural networks, AIT allows us to completely abandon the model of a person working at a desktop in any industries and fields of activity. The growing number of 'disappearing' professions (which previously seemed everlasting) leads to an increase in those engaged in *remote* work. The latter ones not only helps to reduce rental costs and maintenance staff – secretaries, security guards, drivers (according to forecasts, the number of office employees in some companies may decrease by $\frac{1}{3}$), but also changes the management structure of companies that are moving from hierarchical to cloud structure [13]. Therefore, in today's competition for the best talents (and especially from the younger generation Z), companies prefer to abandon 'hard' and 'limited' jobs in order to expand the opportunities for employees to use effective actions that are consistent with their personal values and coincide with the achievement of 'social' corporate goals. Moreover, the tendency to expand work outside the office, which has been discussed all the recent years, was accelerated for all workers in the modern global labour market by the objective reality at one point – after the outbreak of the pandemic of the *Covid-19* in 2020.

These facts indicate that, firstly, the transformation of teaching methods and curricula focusing on stimulating new skills and approaches for a new generation of students who will become socially active in the next 10-15 years is necessary. Secondly, education systems will need to meet the needs of adults and older students and, therefore, must be restructured and modernized, as these groups will gradually become the main users of new educational opportunities. Thirdly, since economic and technical-technological transformations are substantially complemented by socially-conditioned ones, the role of education in the development of such qualities as innovation and creativity, the ability to adequately respond to changes, social leadership, entrepreneurship and the ability to 'creative destruction' is growing, especially for young generation Z. At the same time, since education is often considered one of the most conservative social institutions, it is necessary to find the '*acupuncture points*' of the ecosystem, an area where even minimal effort will produce maximum results in the new social reality. The main reasons for the low impact of educational technology on the rate of change of the dominant educational paradigm are the lack of: a) significant changes in the learning process and in the relationship between a teacher and a student (or a small number of students) in the process of self-orientation; b) integrated platforms that 'collect' various educational modules and solutions into personal 'educational paths' of curricula that are comparable/competitive with existing leading educational institutions; c) corresponding changes in the policy of trust on the part of labour markets, parents and civil society which can make the *new* education more in demand, as well as clarity of intent in the community of teachers and educational institutions themselves.

2. Technological Challenges and New Educational Paradigm

The global demand for higher education continues to grow, and it is estimated that the number of students will increase by 95 million by 2025, which is equivalent to founding 3 new universities a week for the next 10 years [14]. At the same time, according to UNESCO, about $\frac{3}{4}$ billion illiterate people still remain in the world, mainly in the developing countries of Africa, Asia and Latin America. The governing structures and the dominant cultural and thinking models are not able to process and respond to an accelerated increase in socio-technological and environmental complexity. As a growing disparity in skills remains one of the key workforce problems for most big economies, the current state of the education sector requires significant changes with new teaching technologies.

The modern institutional design of the education sector does not correspond to the emerging global context, new practices and new values, and mass education of the industrial era desensitizes, but does not prepare students for life in a complex world, but reduces creative potential and innate ability to collaborate with each other. The growing need for *new* networked education that can provide more relevant content and learning experience today is determined by three factors:

- the growing complexity of socio-technical systems (transport, energy, telecommunications, mass production, etc.) and the demand for new skills and knowledge;
- the widening gap between the potential of existing educational institutions of national systems and the ongoing reproduction of outdated models and ‘cognition methods’ (epistemology) that are not adequate to the challenges of the XXI century;
- new technological innovations in the field of ICT and related fields which require creation of new ways of individual and collective learning and teaching.

These factors create perfect conditions for attracting a variety of new providers, uniting them with students in a network of interconnected learning spaces and processes and creating information flows that allow such systems to become more flexible and adaptive. The emergence of a new entity as a global phenomenon (rather than local or national) is determined by recognition that the main problems of the XXI century (environmental, economic, and political) exist on a ‘planetary craft’ scale, helping to spread the growing common wisdom/knowledge, global content, and culture, on the one hand. On the other hand, it depends on the development of global educational processes and standards influenced by international online learning platforms (for example, *Open edX* ecosystem), global technology corporations (*Google, Microsoft, Intel, etc.*) and leading universities (such as *MIT, Berkeley, Cambridge, National University of Singapore, etc.*). Democratization of the best practices and skillful abilities of Generation Z motivates destruction of the existing systems by innovators even without approval of the national political and business elite (whose interest is based on maintaining the status quo of their power).

The shift of the economy of mass production of material goods to the economy of the mass production of knowledge still has not been able to overcome the imbalance between the principle of ‘open’ access to information and the forms of ‘redistribution of human wisdom’. Autonomous and self-developing machines that are superior to employees in solving intellectual or physical problems are being created, but there are no clear strategies for solving problems that may arise in the short, medium and long term. The scale of updating the ways of thinking and products that are jointly created on the basis of cooperation, creativity and innovation do not correspond to the level of global collective educational potential [15]. To create the conditions for *new* education, radical technological innovations should be combined with radical transformation of personal, relational and systemic aspects of educational systems. Today, four areas of innovation are clearly defined, which are crucial for changing the existing educational paradigm and transition to tomorrow's educational systems.

Firstly, students could increase their level of education with self-orientation. Primarily, it is necessary to imply transition to lifelong learning in the framework of the concept of education as an institutional learning process, while various spaces where individual and collective learning takes place should be modified and adapted to the realities of dynamic contexts. The only way to ensure an employee’s long-term professional stability is radical reoriented development of competencies from passive consumer’s ones to active self-management. The latter comprehensively develop holistic abilities and aspects of the personality throughout the entire life cycle of training, and determine the

demand for new, technology-enriched, personalized educational formats (online courses, educational applications, experience-based learning, etc.) with independent expansion of students' capabilities. The demand for active learning paradigms, conventions and norms across the spectrum, from government and business to family communities, is a key factor in spreading *new* education and educational practices (game/ problem/ project training and its entrepreneurial orientation). Ultimately, educational innovations to serve a student's self-orientation development include:

- ❖ promoting targeted methods, involving necessary training resources, and opportunities for students to test many roles and social situations in a safe and attractive learning environment, creativity and independent thinking and action (for example, problem-oriented learning, 'do it yourself and learn' methods with artistic images, etc.);

- ❖ teaching students various tools and techniques that improve their ability to learn independently (from creating personal curricula to improving their skills of remembering, thinking, arguing and comprehending their own experience, etc.);

- ❖ revising the role of a teacher in the context of maintaining healthy learning environment, transferring knowledge and experience through facilitation and coaching (instead of ensuring one-way knowledge transfer to students) [16].

Secondly, team and community building and networking Although education is usually described as a process supporting personal enhancement and development of skills, in the context of digitalization and ICT, it involves development of collective competencies in teams, organizations and business communities, creating competitive advantages for market entities (universities, corporations, cities and other large social systems) in order to increase the creative potential of teams. That is, it is important that education moves from its current highly individualized focus to integration of individual competencies with the collective ones to create *synergies* between teams, communities and networks of students and their leaders. On the one hand, jointly created synergetic teams, groups and networks of various sizes undergoing collective training should be designed so that they could work both with individuals and with processes of joint creation of artifacts and other products. On the other hand, the space of collective learning should serve individual self-development and self-realization, and complete synchronization of individual and collective learning processes will be one of the key conditions for creating the *new* continuing education.

Thirdly, developing *glocal* educational ecosystems Educational models should be able to respond to different (evolving) needs of students because collective/ collaborative elements of learning groups, communities and networks involve relational and cultural innovation processes. Consequently, the educational ecosystem (in contrast to inflexible educational institutions with the practice of 'industrial' era education) provides means for integrating diverse learning opportunities into an integrated structure — from interconnected networks of educational spaces with individual and institutional providers to holistic (integral) and collective associations (able to challenge the traditional educational system). This implies:

- 'structural stability', maximum productivity, the resource cycle and creation of 'ultimate benefits' (i.e., providing skills training on a scale comparable to higher quality and lower cost);

- dynamic adaptability (the ability to respond to the needs of students and changes in the institutional environment) and scalability (from groups of students or specific educational institutions to communities of the international educational environment).

Accordingly, a full-fledged educational ecosystem is an open and developing community of many providers that satisfy diverse needs of students in a given context or region, on the one hand.

On the other, it is localized, serves regional needs, and connects students in the context. The created *network effects* are no longer limited to a physical presence in one place – learning communities are becoming more global, and the emerging reality of educational ecosystems is *glocal*: they are the link between global and local models, suppliers and competencies. At the same time, there is one danger: the increasing presence of global resources can devalue local knowledge and lead to a softer version of ‘cultural colonialism’ that threatens to destroy national cultural heritage and diversity.

Fourth, indicators of success in learning are changing (developing). Although knowledge-based assessment of cognitive abilities (reading, memorizing facts and dates, and/or solving problems based on patterns) is understandable in conventional assessment through standardized and automated testing, today many of the twenty-first century's most sought-after skills are more difficult to access using traditional methods. Therefore, the level of success of students can be determined by their socio-emotional intelligence, creativity, their ability to cooperate, and collaborative creativity. That is, the task of measuring these abilities as a metric of ‘academic success’ using such a new and dynamic method as ‘*creative profiles*’ describing the range of multimodal abilities is predominant. At the same time, metrics should assume, firstly, ‘portability’, i.e. they should be designed in such a way as to allow students to seamlessly and organically move between learning ecosystems, tracking all learning processes and results, and, secondly, feedback. The measurement of competencies contributes to the development of ‘*portfolios*’ of practical training and research that represent abilities and talents in real-life conditions (in contrast to traditional diplomas and certificates, which are becoming increasingly irrelevant). This changes the nature of learning success indicators and contributes to creation of platforms (including application programming interfaces or *APIs*) that connect many areas of learning and experience across the entire spectrum of the learning model. If the previously existing concept of ‘success’ was associated with a rigid relationship between powers and abilities, today the success (‘personal sign of contribution’), which is achieved at the expense of others, looks not so much as a short-term acquisition, but as a long-term failure. Therefore, modern ‘trading platforms’ connecting individual students with learning opportunities that exist in other organizations and communities (including requests for participation in a project/task/game) are at the same time platforms for finding work with wider functional capabilities.

The changing educational paradigm is directly related to the new role of global educational platforms that form educational ecosystems. Indeed, according to existing studies, over the next 15-20 years, online learning (improved through mobile communications, gadgets and augmented reality technologies) will turn into a global form of education (separating the learning process from traditional places such as an audience and a university) [17]. The transition to global training platforms involves solving a number of system tasks:

- ❖ first, overcoming mistrust on the part of the labour market and traditional education system for online learning, due to the lack of: a) a transparent way to determine the quality of online courses so far, b) guarantees for identifying people who completed the course and passed the exam (it is urgent to develop appropriate technologies and processes to combine spatial online learning and traditional learning ecosystems based on mixed experience);

- ❖ second, although online learning remains very useful, its completion does not usually affect students’ professional or educational progress (high mistrust of employers and academia);

❖ third, online courses were considered as separate, independent events ('one-time'), while educational curricula usually provide for interconnected and interdependent training courses (agents or platforms are needed as 'integrators' of various online learning processes);

❖ fourth, despite the wide range of opportunities offered by new ICTs, online platforms are still not innovative enough (they are considered to be *destroyers* rather than *creators*).

It is assumed that as these problems of online learning are resolved, the potential growth of global educational platforms will become unlimited, and network communities will gradually create a new type of global *knowledge ecosystem* (digital codes will replace texts as the dominant form of human knowledge). Thus, for example, it took *Facebook* a little over 10 years to turn from a startup idea into a platform actively used by 2 billion users; the *EdX* platform is able to reach 1 billion students by the mid-2020s, LinkedIn, being a more specialized social network, is approaching 500 million users, and Wikipedia as an ecosystem of the global knowledge repository, over time (over the next 15-20 years) will replace traditional libraries [18]. On the one hand, knowledge 'in the structures of distributed networks leads to anonymity of creators, on the other hand, educational platforms change the modality of their interaction with students: there is a transition from user-readers and courses with a version of highly interactive 'textbooks' to virtual laboratories where simulations and experiments are conducted. Different types of digital educational solutions already exist as niche products (prototypes) and are likely to expand as the demand for individual student learning experiences grows:

- 'digital textbooks' (interactive hypertexts) and mobile devices with built-in AI-functionality which play the role of personal mentors;

- simulators for game learning, development of participation skills in educational scenarios (augmented reality) and wearable devices (fitness bracelets with enhanced functionality and biological feedback) for training various psychophysical behaviours [19].

The level of development of digital teaching methods allows, firstly, to customize the content and learning processes taking into account the student's behavioural models and practical strategies (including career, health, etc.); secondly, to determine the degree of personalization, which is based on current skills/ knowledge and learning objectives within individual specialized platforms; thirdly, to synthesize behavioural data obtained in touch interfaces of digital textbooks, and which allow us to identify cognitive abilities and the student's preferred learning style. Over the next 15–20 years, such technologies will make it possible to provide personalized education to every technically equipped student [20]. Today, in addition to universities, which have long turned into the 'central nodes' of educational network spaces, three other spaces are becoming more and more relevant and accessible:

- ❖ global (online) training platforms as the main providers of global knowledge and content;
- ❖ local learning formats to meet a wider range of students' lifelong needs;
- ❖ spaces for learning based on high-tech personalized and collective experience of human interaction and joint creativity.

In the future, integrator universities will appear in the field of mass higher education, which will practice the so-called 'composite degrees', when students independently choose online courses for themselves from a set of possible ones, and the institution recognizes them and issues a bachelor or master degree. That is, only the results and time spent on their confirmation, instead of the place where this training took place will be monitored in the educational environment. In turn, thanks to online technologies, students will not only choose the courses of famous universities, but also mark

them as a part of the educational course (a ‘microdegree’ indicated in the resume along with the undergraduate or master’s degrees of the base university). As a result, educational products will lose their university academic status as digital interactive systems will erase the difference between major and additional education.

A promising achievement in education should be empathy-based or empathy-oriented learning, which is largely driven by global communication technologies. This is a form of bioorganic need that serves to expand perception and creates preconditions for emergence of new levels of communication, cooperation and consciousness (as opposed to linear, one-profile and mechanistic thinking and approaches that are hopelessly outdated).

The new principles of the educational ecosystem paradigm should, firstly, ensure continuous monitoring and registration of learning outcomes in each ‘block’ of training programmes (except for final and qualification exams), and secondly, have universality and portability function to determine educational achievements and level of competencies. That is, the process of ‘smooth’ movement between the areas of study involves expansion of the student’s portfolio/profile of training, which turns into a kind of a ‘meta-platform’ of personal data. On the one hand, interoperability or a standard meta-platform can enhance individual learning paths of individuals and communities, and on the other, they can cause problems with aggregated online personal data, their abuse and manipulation, privacy and social engineering. Therefore, it is very likely that most students will make decisions regarding professional growth in the foreseeable future, receiving pre-designed packages of learning experience.

Conclusions

According to the analysis, the ‘revolutionary potential’ of new educational technologies is low not because of their quality, but because of the context of application of these technologies. The latter is determined by the skills/practice of teachers and students, the level of the *new* education infrastructure environment development (platforms, institutions, social norms, etc.), and the degree of social and technical environment development (joint design of social and technical systems using models and concepts of the innovative educational process). Nowadays, quite often the collective energy and attention of *educational innovators* is focused on transformation of educational models of universities as ‘educational centres’ without taking into account other integrator entities that shaping the educational landscape in the rapidly changing realities of Industry 4.0. Although ICT and DT play a crucial transformative role in education, but with inadequate linkage with social technologies, they tend to fail and do not work as a sufficiently effective investment. Today, student assessment indicators need to be more ‘holistic’ (‘new success indicators’), which should include various aspects of psycho-physical and emotional development, creative thinking, and P2P mentoring. One way or another, they are replacing the curricula created by ‘industrial education’, otherwise the design of future education technologies (EdTech innovations) and their actual application will simply turn out to be minor ‘cosmetic’ changes introduced into the process of transforming the current educational paradigm of educational organizations.

References

1. McKinsey (2017a) A Future That Works: Automation, Employment and Productivity. Retrieved from: <https://www.mckinsey.com>
2. Frey C.B., Osborne M.A. (2017) The Future Of Employment: How Susceptible are Jobs to Computerisation? *Technological Forecasting and Social Change*, 114. Retrieved from: <https://www.sciencedirect.com/science/article/pii/S0040162516302244>

3. BCG (2018) The Impact of Artificial Intelligence (AI) on the Financial Job Market. Retrieved from: http://image-src.bcg.com/Images/BCG-CDRF-The-Impactof-AI-on-the-Financial-Job-Market_Mar%202018_ENG_tcm9-187843.pdf
4. McKinsey (2017b) Jobs Lost, Jobs Gained: What the Future of Work Will Mean for Jobs, Skills, and Wages. Retrieved from: https://www.mckinsey.com/~/_/media/mckinsey/featured%20insights/future%20of%20organizations/what%20the%20future%20of%20work%20will%20mean%20for%20jobs%20skills%20and%20wages/mgi-jobs-lost-jobs-gained-report-december-6-2017.ashx
5. Bringsjord S., Govindarajulu N.S. (2018) Artificial Intelligence. *The Stanford Encyclopedia of Philosophy* / E.N. Zalta (ed.). Retrieved from: <https://plato.stanford.edu/archives/fall2018/entries/artificial-intelligence/>
6. Brynjolfsson, E. & Mitchell T. (2017) What can Machine Learning Do? Workforce Implications. *Science*, 358 (6370), 1530–1534.
7. Gunning D. (2017). Explainable Artificial Intelligence. Defense Advanced Research Projects Agency (DARPA). Retrieved from: <https://www.cc.gatech.edu>
8. Belousov, D. (2018) Development of the Digital Ecosystem: Direct and Indirect Effects for the Economy. Retrieved from: http://www.forecast.ru/_ARCHIVE/Presentations/DBelousov/2018-03-31IT-ECO.pdf [in Russian]
9. Koznov A. B. (2019) The Impact of Digitalization on the Labor Market. Retrieved from: <https://cyberleninka.ru/article/n/vliyanie-tsifrovizatsii-na-rynok-truda> [in Russian]
10. Arntz, M., Gregory, T. & Zierahn, U. (2016) The Risk of Automation for Jobs in OECD Countries. A Comparative Analysis. OECD Social, Employment and Migration, Working Paper No.189.
11. Dyatlov, S.A. & Dobrokhotov, M.A. (2018) Forms of the Implementation of Human Capital in the Digital Economy. *Izvestiya Sankt-Peterburgskogo gosudarstvennogo ekonomicheskogo universiteta*, 25-28. [in Russian]
12. Forbes (2018) How AI Builds A Better Manufacturing Process. Retrieved from: <https://www.forbes.com>
13. Fossen, F. & Zongner, A. (2019) The Future of Labor: the Destructive and Transformational Effects of Digitalization. *Foresight*, 13(2), 10-18. [in Russian]
14. Jacobs G. (2014) New Paradigm: the Necessity and the Opportunity. *Cadmus* 2, 2, 9-23.
15. Labour Market s in a World of Continuous Change. (2015) The Hays Global Skills Index 2015. Retrieved from: <https://www.hays-index.com>
16. Soto, D. A. (2020) Technology and the Future of Work in Emerging Economies: What is Different, OECD Social, Employment and Migration, Working Papers 236, OECD Publishing.
17. Tuccio, M. (2019) Measuring and Assessing Talent Attractiveness in OECD Countries, OECD Social, Employment and Migration Working Papers 229, OECD Publishing.
18. ILO (2020) World Employment and Social Outlook. Trends 2020, International Labour Office, Geneva. Retrieved from: <https://www.ilo.org>
19. Nedelkoska, L. & Quintini, G. (2018) Automation, Skills Use and Training OECD Social, Employment and Migration, Working Papers 202, OECD Publishing.
20. Labour Market Outcomes: Trends and Analytical Framework. (2017) Trade, Technology and Jobs. World Trade Report 2017. Retrieved from: <https://www.wto.org>

Kateryna Malinoshevska

PhD., Financial Director of «Highline Media» Ltd.,

Kyiv, Ukraine

STRATEGIES OF MODERN INTERNATIONAL ECONOMIC RELATIONS IN THE CONDITIONS OF WORLD ECONOMIC GLOBALIZATION

***Abstract.** One of the characteristics that determine the development of the world economy today is its globalization, which not only changed the production process itself, internationalized factors, technologies and means of production, which allowed within one process of value creation to use a set of advantages of different national economic systems. transformed such fundamental macro- and microeconomic principles and principles as competition, pricing, state regulation and so on. Among the trends of modern world development are the process of globalization, on the one hand, and increased activity of regional integration on the other. The development of international financial relations, as well as the economy as a whole, is based on the laws of cyclical development - rapid development is replaced by a slowdown in growth, and sometimes crises.*

1. Introduction

In recent years, globalization and regionalization have a special place among the main trends in the modern world economy. The modern world economy is becoming characterized by a single global system, but more and more states are uniting in various blocs and alliances. And most often the main criterion is a regional feature. The financial and currency crises of recent years have demonstrated the need to achieve stability in international financial relations. In the context of globalization, contradictory processes in financial markets, exchange rate fluctuations, global financial instability, ie the state of the international financial system, is internally contradictory and unbalanced, which increases the likelihood of unpredictable changes in financial markets and can lead to external shocks and financial crises. . Changes in the global financial system due to financial globalization have primarily contributed to increased international capital flows. However, in addition to the positive consequences of this process, such as financing the balance of payments deficit, the spread of new technologies, etc., increased capital flows have led to increased financial instability. In addition, due to easier access to information and greater dependence of individual countries on foreign investment, globalization is exacerbating the imbalances inherent in domestic markets, which significantly affects the frequency of international financial crises. Therefore, one of the consequences of globalization can be considered the extremely rapid spread of various crises and an increase in the number of countries affected by them.

Globalization is a new, higher stage in the development of productive forces (or in the development of factors of production), in the processes of international division of labor and, accordingly, in the internationalization of production and capital. Globalization has a direct impact on global and regional integration processes, in some cases positive (accelerating the unification process), in others destructive (offering facilitated "alternatives").

Regarding economic globalization, it is a process, the substantive side and essence of which is the current stage of internationalization of all spheres of financial and economic life of the world community, accelerated development of universal factors of production and intensification of these processes on the basis of new information technologies. systems. In a shorter definition, economic globalization is seen as a modern stage of internationalization of all spheres of economic life on the basis of the latest information technologies and communications.

2. Strategies of modern international economic relations in the context of world economic integration

The term "international relations" belongs to the English thinker Jeremy Bentham, who understood it as relations between states. Subsequently, it passed into jurisprudence and was used exclusively to denote legal interstate interactions.

Back in the early twentieth century, it was difficult to define the boundaries of the subject of international relations and to present it in evidence. In particular, the Dutch historian Vlekke, who headed the first department of international economic relations in Leiden, failed to do so. In his inaugural speech, he was unable to define international relations as a scientific discipline. The famous French sociologist R. Aron explained this fact by the fact that international relations do not have clearly defined boundaries and they can not be materially separated from other social ties. Although on the eve and during the First World War the main attention in the study of international relations was paid to diplomatic history, and in the interwar decade to the problems of the functioning of international law and the activities of international organizations.

In general, international relations were considered by "modernists" primarily as a normal set of foreign policies of individual states, which made it possible to identify the best means of achieving certain national interests, but underestimated the danger of their collision. In general, the only problem of both approaches to understanding international relations was the fact that neither of them represented international relations as a holistic system in the functional unity of its components on the one hand, and as activities in the international arena of various political institutions (states, peoples, public organizations and social movements, etc.) - on the other [1].

In fact, M. Merle proposed to introduce a new criterion for determining the specifics of international relations and called it a "criterion of localization." According to this criterion, the specificity of international relations is defined as "a set of agreements or flows that cross borders or tend to cross borders." This definition allows us to take into account the peculiarities of each stage in the development of international relations and not to reduce them only to interstate interactions. Its content also fully fits into a variety of classifications of international relations. Based on the system approach and the "criterion of localization" of M. Merle, we can define international relations. The most acceptable definition of international relations is a set of systems, political, economic, diplomatic, legal, military, humanitarian and other relations and relations between the subjects of the world community, which include the state, people, society and social movements, various organizations and sub objects of national economies. A kind of attempt to combine both points of view on the definition and content of international relations can be considered the definition of political scientist V. Kravchenko - all forms of exchange of activities that are the subject of relations between states (legal, scientific, technical and industrial and many others), up to individual communication, form international relations".

Types of international relations are also considered by two criteria: in the spheres of public life; according to the content of relations, economic, political, military-strategic, cultural, ideological, scientific and technical are distinguished. Based on the interaction of participants or authors, a distinction is made between interstate and inter-party relations, relations between various international organizations, transnational corporations, etc. The main issue of international political economy is the question of the relationship between the state and the market. Most experts in the field of IEA consider them through a structural analysis of public authorities. In particular, S. Strange names four structures with which the government interacts - the structures of production, security, knowledge and finance [2].

According to the author, the international system is an arena of continuous struggle, clashes, negotiations and compromises of different types of government, which seek to impose their vision of resolving the contradictions of these four structures. Currently, in this struggle there is an advantage of impersonal market forces, due, firstly, to the technological revolution, and secondly, the rising cost of capital and the growing need of enterprises to finance their activities.

All this was no longer regulated by laws (although they remain formal), but by internal regulations of the firms themselves. They are playing an increasing role in the tax sphere, putting the fiscal authorities to serve their interests. Large corporations undermine the role of the state in security policy, economics, communications and even encroach on the absolute monopoly of the state on violence (acquire police forces, search services, private prisons). However, having made a brilliant analysis of how the state is "reduced", "washed out" of its functions, S. Strange concludes that all this does not mean the possibility of "disappearance" of the state or its transition to full control of a multinational company. . The relationship between institutional, political and economic power, as history shows, is a variable factor, variable. Today the situation is not in favor of the state, but this fact may change tomorrow.

"Globalization" is a key category of "economic structuralism", which is seen as a natural process of development of factors of production, and as a consequence of the strategy of large corporations. The "new political economy" further reinforces these provisions, explaining the "incorrectness" of the question of regulating the processes of globalization, as they are objective laws of development in the modern technological revolution. Thus, attempts to exert state influence on markets that are subject exclusively to economic laws are also considered, while any other intervention may lead them to "disruption." The whole system of arguments of the supporters of the "new political economy" of international relations thus leads to the conclusion that it is necessary to "depoliticize" modern economic processes. Representatives of this school, such as A. Krueger, R. Palan, D. Collander and others, try to justify the idea that state regulation of the national economy is an irrational process at its core, it should be replaced by self-regulation, or the market. Eventually, international economic relations will be depoliticized, the base of interstate conflicts will weaken, and the role of the state will focus on purely representative functions. According to the above-mentioned scientists, global liberalization should be extended on a universal basis, and if necessary, with the use of force, while the capabilities of the state in this case are not excluded [3]. The paradox is that the state must use its powers to ensure its own destruction. But the bold theory of neoliberals does not bother (Table 1).

Table 1. Stages of regional economic strategy

Stages	Example
Free trade zone	European Free Trade Association (1958-1969), North American Free Trade Agreement - NAFTA (1994), Baltic Free Trade Area (1993), ASEAN Free Trade Agreement (1992)
Custom Union	European Union (1968–1976), Benelux (since 1948), Customs Union of Belarus and the Russian Federation
Single internal (common) market	European Union (1987–1992), Caribbean Common Market - CARICOM (1973), Common Market of South America - MERCOSUR (1991)
Economic and monetary union	European Union (since 1993), Arab Maghreb Union (1989), West African Economic and Monetary Union (1994), Commonwealth of Independent States - CIS (1992)

However, the use of force is envisaged only as a last resort. Proponents of this doctrine consider the current capabilities of international organizations such as the WTO, IMF and others. to openly impose the concepts of neoliberalism and international monetarism on those countries that exercise some caution in choosing economic policies based on these ideas, although neoliberalism has virtually conquered the entire economic world.

Neoclassical during its modern neoliberal variety, represented in international political economy, is characterized by pronounced dogmatic postulates, complicate theoretical compromises, attempts to "displace" the political element of international economic relations, the proclamation of such freedom of market forces, which did not exist even in Queen Wie the flowering of liberalism and free trade, minimizing state regulation of domestic and international economic processes [4].

Perhaps the fact that, despite the constant "disruptions" of economic policy based on neoliberal monetarist concepts, the ideas of this school are spreading with impressive persistence around the world, due to the fact that the doctrine meets the strategic interests of TNCs unique in their combined global power. a lobbyist who exceeds the capabilities of any state, if not most of them. Thus, it is no coincidence that their power, influence on politics, social relations, and the position of the working masses in the world economy are constantly increasing. But the main reason lies in the following: all countries are becoming increasingly interconnected and interdependent, with weak countries becoming more vulnerable, and their ability to influence their own economic policies is increasingly reduced in conditions of dependent development. Criticism of neoclassicism in its liberal form is based on the analysis of real contradictions arising from international economic policy based on this doctrine, growing inequality of states and peoples, disruption of world economic balance, exacerbation of social problems, loss of state organic functions, etc.

Representatives of neo-Marxist political economy can rightly be considered the most radical critics of theories of neorealism, neoliberalism and the "new political economy". They have played a significant role in the development of modern international political economy. The neo-Marxist trend is quite broad and heterogeneous throughout politics and economic thought, which radically distinguishes it from traditional classical Marxism. To talk about the "marginality" of neo-Marxist concepts, therefore, is fundamentally wrong, especially since in a certain shortage of strategic ideas in the field of economic theory, the emergence of new conceptual ideas are likely to be expected from schools in developing countries.

It is a known fact that a large role in the formation of the neo-Marxist trend in international economic theory was played by the work of a group of scientists led by Argentine economist R. Prebisch in the United Nations Economic Commission for Latin America and the Caribbean in 1950. Prebisch and his group of consultants made well-founded critiques of the concepts, which limited the analysis of the economic situation in the region to a narrow framework of neoclassical views of realism based on "factor-oriented" approaches. Prebisch subjected this concept to devastating criticism, arguing that the capitalist division of labor on the continent preserves backward forms of such a division between countries exporting raw materials ("endowed with the labor factor") and countries exporting finished products ("endowed with the capital factor").

Prebisch discovered a number of interdependencies, comprehensively considering the problems of "peripheral capitalism" on the example of Latin America. Overcoming the dependence of the "periphery" on the "center" Prebisch associated with a radical overhaul of economic policy of the continent, which could help change the structure of the economy, not focused on exports of raw

materials, but primarily to meet the basic needs of the continent, new principles industrialization ("import substitution"), accounting for TNCs of the interests of host countries, etc [5].

Well-known neo-Marxists, including W. Wallerstein, S. Amin, W. Galtung, R. Cox and others, define international relations as a global system of interaction of various states, economies, societies, ideologies and cultures. The basic concepts used by neo-Marxists are "world system" ("world system") and "world economy". The concept of "world economy" reflects the system of transactions of international agents, in which the economically strongest of them play a decisive role. The main features of the evolution of the world economy, according to their views, are the world organization of production, the growing importance of TNCs, financial institutions and commodity markets in the segmentation of the labor market, standardization of consumption patterns, reducing opportunities for government intervention in finance, global trend of "financing" with financial instruments), total privatization.

Neo-Marxist scholars harshly criticize the world capitalist system for dismantling the policy of full employment, reducing social spending, changing tax (fiscal) systems in favor of rich countries, etc. States lose their social functions, the population is left alone with powerful corporations that receive elements of state power (along with the social functions that pass to them), which in turn accelerates the process of inequality between members of the international system. In turn, this leads to the fact that the "peripheral" members of the system, namely underdeveloped countries and regions, are deprived of even remote opportunities to close the gap between them and the "centers". The ideology of "hyperliberalism" (radical liberalism), which is dominant in the world system and is designed to serve the interests of rich countries, is particularly sharply criticized. The role of the state is viewed by proponents of "hyperliberalism" from the standpoint of the interests of global market forces, rejecting even attempts to redistribute some of the wealth in favor of poor countries, considering it a "protectionist intervention." Radical-liberal ideology imposes on the mass consciousness the idea that there is no alternative to globalization for TNCs, because we are talking about objective economic laws, very reminiscent of the past dogmas of Marxism ("iron laws of Marxism"). Proponents of this ideology, openly designed to serve the interests of developed countries and the ruling classes in poor countries, including the new capitalist countries (Russia, Eastern Europe, Central Asia), seek not to notice the opposite trends that are developing in the modern world system - diversification economic, political, social, socio-cultural relations [6].

The "Center" stubbornly seeks to preserve its privileges and the opportunity to profit from unequal exchange with the "periphery", so the latter is less and less connects its interests with the "center". Poor countries and their peoples do not see any interest in seeking a rapprochement with the "center", which gives impetus to the development of autonomous processes on the "periphery". All this creates a new dangerous situation, which is impossible to control from the "center". According to supporters of the neo-Marxist model, the only way out is to abandon illiberal politics, in the words of S. Amin, "unbridled globalization." According to Amin, such globalization is the result of five monopolies, which led to its destructive nature for poor countries and peoples:

- a) monopolies on new technologies;
- b) monopolies on the control of financial flows;
- c) monopolies on access to natural resources;
- d) control of strategic communications;
- e) monopolies on the possession of weapons of mass destruction.

The main task of the countries dependent on the "center" is to implement a strategy of "break" with the current system through the destruction of the dominance of the "center", its power through the "front of anti-system forces." The formation of such a "front" can be achieved by intensifying positive nationalism on ethnic, religious and chauvinistic forms of nationalism, which are widespread and stimulated by the strategies of big capital. Positive nationalism presupposes regional cooperation and proceeds from the need to form closely integrated regions, including border countries, which are able to wage an active struggle against the above-mentioned "five monopolies". If integration entities in Africa, Latin America, around mainland China and India, and in Europe, in the Arab East, are based on people's and democratic unions, they will ultimately force capital to take into account the demands of such alliances of states and peoples. The next step of the unions should be new programs for intra - and interregional interdependence, including expanding investment in manufacturing sectors, mutual trade, stimulating capital markets, etc. A set of such programs can provide strong dynamism of democratic restructuring, up to the world system . According to Amin's concept, they can become tasks of the long-term perspective of "the transition from world capitalism to world socialism, which takes place through a number of stages."

Similar ideas are developed by R. Cox, another prominent representative of the neo-Marxist theory of international economic relations. It also analyzes the processes of globalization, the rapidly growing power of large capital while reducing living standards and the refusal of states to perform their social functions, which inevitably leads to growing dissatisfaction not with individual parties to the existing system but with the system as a whole. Therefore, the increasing coordination of human actions and the establishment of links between them will continue to strengthen, which will have an impact on the world system [7].

The ideas of the neo-Marxists have some influence not only on research in the field of international political and economic relations, but also on the sociology of international relations and even more so. After all, for any dominant theory that reflects the interests of the ruling strata, there is a decline, a shortage of promising strategic ideas. Neo-Marxist scientists, speaking from radically different positions, whose task has radically changed the situation, find more promising and exciting ideas. As long as the modern world exists, revolutions will never end, and therefore there will be no shortage of revolutionary teachings and theories designed to reflect one of the possible directions for resolving contradictions in world development.

3. Strategies of globalization and unification processes

In recent years, many definitions of both globalism and globalization have emerged. One of them, for example, characterizes this phenomenon as "the change of all aspects of society due to the planetary tendency to openness and interdependence." According to another definition, "globalization is a process of rapid formation of a single global financial and information space based on new, mostly computer technologies."

It is known that the term "globalization" first appeared in the American press in the early 1980s, in an article by P. Levitt in *Business Review*. Under him, Levitt understood a new phenomenon in the process of merging the markets of individual products produced by multinational corporations. Previously, such forms of mergers were impossible due to insufficient development of information potential of corporations. The term "globalization" appeared, first, in the field of economics, in particular on the basis of the study of new phenomena in the activities of major corporations and international financial transactions; secondly, in connection with the use of new information and communication systems in production and financial and banking activities.

Globalization as a phenomenon is just unfolding and is thus in its infancy. Hence the uncertainty in the interpretation, and attempts to contrast it with such a classic concept as "internationalization". Some believe that globalization is the highest stage of integration, which began in the 90s of the twentieth century. But this is a wrong conclusion. Based on the fact that the term "globalization" appeared in the 1980s, it should be assumed that it already reflected a new phenomenon, including a new qualitative stage in the field of internationalization and integration of the world, under the strong influence of the information and computer revolution. Thus, globalization is a phenomenon that has evolved since the initial stage of the information revolution, but described in the 1980s.

The opposition between integration and globalization seems completely a priori incorrect. Integration is a phenomenon and a process that has its point of reference. Thus, integration received a powerful impetus to development after the Second World War in the scientific and technological revolution, when the process of intertwining industrial and financial ties of different countries, especially border developed countries, began to become pronounced, necessitating their increasing rapprochement through specific state policy of each of the participants in the integration process and through joint collective efforts on the basis of the bodies of supranational management of the integration process created by these participants.

Globalization as a complex complex phenomenon has, accordingly, a complex composition, structure, requires research at a number of hierarchical levels: economic globalization, financial, informational, cultural, political, etc. This greatly accelerates the process of interaction between nature and human activity, causes quite definite, detrimental to the share of civilization consequences. All these processes that accompany globalization are manifested in the most complex way. On the one hand, there are unusual opportunities for the world community to solve many problems, including those caused by civilization itself, on the other hand, the increase in poverty and destitution in the world, disease, regional military conflicts, etc.

Speaking of financial globalization as an integral part of economic globalization, researchers, however, have not yet given a clear definition (as well as economic globalization itself). For some, it is associated with a chaotic situation and excessive freedom given to the market and speculation. Others, on the other hand, argue that there is no reason to believe that private capital markets are malfunctioning. Others assume that "a new configuration of the world economy was emerging in the 1980s, when financial issues and mechanisms for regulating them came to the fore: the transition from a state-regulated system to a market-driven system." But everyone agrees: the process of financial globalization is accompanied by international monetary and financial instability. This is the main feature of financial globalization [8].

Financial globalization is part of the general economic globalization, the essence of which is to strengthen the links and relationships between the financial sectors of national economies, financial centers in the world economy, international financial institutions. This is a new qualitative stage in the internationalization of the entire global financial system based on the latest information technologies, which is the largest dynamic subsystem in economic globalization. With a positive assessment of the process of globalization of financial flows, some researchers say that there are opportunities for individual entrepreneurs to protect themselves from the risk of unexpected and abrupt changes in exchange rates and interest rates; to quickly adapt to financial shocks that arise as a result of, for example, oil crises; guarantee a degree of discipline in economic behavior by preventing governments from pursuing inflationary and debt-raising policies.

Table 2. Causes and features of instability of the world financial system in the context of globalization

Reasons	Characteristic
financial liberalization and deregulation	intertwining of financial and currency imbalances
integration of financial and currency markets	significant fluctuations in exchange rates and financial indicators in international markets
change of currency regimes	absence of clearly expressed tendencies (cyclic, dynamic and structural)
intensification of global capital movements	increasing risks of operations in international currency and financial markets
imbalance in the relationship of major players in global markets	a sharp change in the dynamics of financial indicators

As a result, when basic capitalist relations operate all over the world, pursue a more prudent economic policy. Accordingly, there is a general trend of streamlining financial flows in the world economy. However, these are purely hypothetical judgments, which are formulated on the basis of the general development of globalization. The positive consequences may not show their presence and even more so are not realized. Most predictably, globalization in the field of financial flows can lead to destructive processes, as there are factors that determine the immediate transfer of the crisis that arose in one country, to the entire world economy or large regions of the world. The current level of world market mechanisms is extremely imperfect and unstable and cannot play the role of a global regulator, as speculative methods of market players are a property of the market as such and agents in it. In addition, supranational methods of regulating financial flows are not adequate to influence the carriers of globalization (TNCs, states, international financial organizations, large individual financiers, even individual large banks, etc.), whose actions may subject a country or group of countries to financial chaos [9].

There is a great need to take into account the peculiarities of the world economy:

- The first feature. When we talk about the world economy as a phenomenon and as an object of knowledge, we mean a complex set of national economic systems and other subsystems operating at different hierarchical levels. Since the world economy is not an independent subject of relations, because there is no world state, world government as a carrier of world state sovereignty. At the level of the world economy, there is no adequate sovereign entity, which is a nation-state with its national economic system. For many centuries, the world community, convinced of the need to adhere to certain rules of economic behavior by countries to avoid chaos in the world economy and international economic relations. They enter into force through the approval of the national legislature, or through the signing of international treaties and agreements, which may or may not be approved by the relevant legislature, but take legal effect.

- The second feature. The process of rapid intertwining of economic ties between countries, which began with the Great Geographical Discoveries, accelerated tremendously after World War II. In a world of rapid growth of a group of developed countries strengthened trade, economic and financial ties and relationships between them, increased mutual flows of investment, labor migration, tourist and business movements of large numbers of people, etc. This required the rapid formation of complex mechanisms for their regulation and regulation, which was not possible in the global economy. The unsolvability of these tasks is largely explained by the fact that there was no need for their real solution: intensive interstate relations have developed and are developing not evenly, but on a regional basis at different levels and different degrees of internal legal regulation.

• The third feature. There is an urgent need for global regulation of world economic processes, bringing the regulatory framework under the system of international economic relations. It seems wrong to analyze these phenomena in the framework of traditional approaches, which link the causes of the crisis only with the behavior of investors and the shortcomings of government policy. Whatever financial capabilities the IMF has with its oversight functions and assistance in conducting economic policies in individual countries, sets the task of combating poverty, these organizations are simply unable to solve their statutory tasks, and, as many years of experience, they are not one step closer until they are resolved. At the same time, it has become clear that financial globalization, as the most modern sphere in the world economy, poses a formidable danger of overthrowing the entire world financial system, and at the same time the world economy.

• The fourth feature. The policy of protectionism, despite the obvious successes in overcoming it, continues to thrive in the current global financial and economic crisis, nullifying the results of half a century of trade liberalization. Many prosperous countries, in favor of "their" corporations, without feeling remorse, easily violate the WTO agreements signed by these countries, thus setting dangerous precedents. An example is a very frivolous attitude to the international treaty by a whole group of developed countries. In turn, developed countries sought to improve access to markets for goods and services of developing countries, especially the most developed of them (Brazil, India, etc.).

Special Safeguards are measures (additional fees) that countries can use in the event of an unexpected and sharp increase in imports or a sharp drop in prices for previously non-tariff measures that have been converted into customs duties in accordance with the provisions of such a transformation.

4. Conclusions

The study of the impact of economic integration strategy on world economic dynamics proves that the development of globalization cooperation between countries contributes to the creation of a special economic space within which a special economic regime is applied, joint coordination of economic policy in different areas languages compared to non-regional. As a result, intra-regional cooperation within the framework of the integration association is developing at an accelerated pace, and the integration association itself is consolidating its status as a relatively isolated part of the world economy. The development of regional economic integration has become significantly more active in modern conditions, which, in turn, has become one of the factors that determine the nature of trade and economic cooperation in the world. The growth of foreign trade is observed among all regional trade associations, which is evidence of the trend of increasing regionalization in the world economy. In general, globalization associations provide a stable basis for expanding trade and developing other forms of interaction. Thus, the paper substantiates that the process of regional economic integration is one of the most important institutional components of the process of transformation of the world economy. As a result of the development of globalization processes, administrative and economic barriers are being eliminated, and interstate and transinstitutional diffusion of financial and information technologies is taking place. The readiness of countries for regional economic globalization allowed us to conclude that it is necessary to form an effective mechanism and develop a vector of development of globalization processes aimed at forming an integrated regional economic and monetary-financial system in the globalization of the world economy.

References:

1. Levitt, T. (1993). The globalization of markets. Readings in international business: a decision approach. Harvard Business Review.
2. Margolis, H. (1984). Selfishness, altruism, and rationality. University of Chicago Press.
3. Nye, J. S. (2011). The future of power. Public Affairs.
4. United Nations (2013). Trade and development report 2013. United nations conference on trade and development. New York, Geneva : United Nations.
5. Laczko, F., & Gozdzik, E. M. (2006). Migration for Development: Within and Beyond Frontiers.
6. Mazzucato, V., Van Den Boom, B., & Nsowah-Nuamah, N. N. (2008). Remittances in Ghana: Origin, destination and issues of measurement. *International Migration*, 46(1), 103-122.
7. Kaminsky, G. L., & Reinhart, C. M. (2000). On crises, contagion, and confusion. *Journal of international Economics*, 51(1), 145-168.
8. Salvatore, D. (1998). *International Economics*. New Jersey: Prentice Hall.
9. Sussman, N., & Eichengreen, M. B. J. (2000). The international monetary system in the (very) long run (No. 0-43). International Monetary Fund.

Viktoriia Levchenko

*Ph.D. in Philosophy, Associate Professor, Department of Philosophy and Education of Adults, State Higher Educational Institution "University of Educational Management", National Academy of Educational Sciences of Ukraine, Central Institute of Postgraduate Education, Kyiv, Ukraine
orcid.org/0000-0003-4691-9445*

Inna Forostiuk

*Ph.D. in Pedagogy, Associate Professor, National University of Food Technologies, Kyiv, Ukraine
orcid.org/0000-0001-8691-3203*

**CULTURAL AWARENESS OF ACADEMIC AND TEACHING STAFF
IN THE LIFELONG LEARNING CONTEXT**

Abstract. *The importance of forming cultural awareness of academic and teaching staff is with the help of a competency-based approach, as a means of a person's self-expression and enrichment of the possibility of scientific knowledge is emphasized in the article. Definitions of the concept of cultural awareness and its components are considered by the authors. The content of tasks for the development of cultural awareness of high school academic and teachers is disclosed. The personal traits that mostly influence the adaptation and socialization of academicians to new cultural environments are shown. Among them are: openness, communicativeness, flexibility and tolerance for uncertainty. The authors note as the necessary conditions for the formation of cultural awareness in the context of lifelong learning the development of its basic components, such as linguistic, intercultural, sociocultural and personal. The competency-based approach was used to achieve this goal. It is stated that the effectiveness of the development of cultural awareness and self-expression of teachers increases in the context of integration of culture, religion and national interests of the Ukrainians.*

Introduction.

The most important task of modern education is to create a space for preserving and passing on to the next generations the experience of their native country as well as the world experience, and at the same time to define and preserve the values of each historical period and to create the conditions for the formation of a certain cultural type of a person. All these purposes correspond to the tendencies of personal development, freedom for self-determination, openness and respect for other cultures. The urgency of this task grows in times of the individual and country crisis, because any nation has a chance to get out of the crisis owing to the idea of statehood and national interests, and also its culture and religion. On the other hand, the development of science also requires a connection with the spiritual experience of civilization and culture [1], which activates the self-development of a person, reveals his cognitive abilities. So, the university is the unique environment in which science and culture intersects interfere.

In the context of the "lifelong learning" concept it becomes obvious the need to transform knowledge for the further development of the individual in the situation of constant changes, including adaptation and socialization to new conditions, adoption of new social roles, establishing productive relationships with representatives of other cultures, creating an individual educational trajectory for a person's self-realization.

The research is aimed at the theoretical level of the study of cultural awareness, at the empirical study of its components and at the tasks of developing cultural awareness in higher education, as a means of enriching the possibility of scientific knowledge.

The Leuven Conference of Ministers responsible for higher education, "The Bologna Process 2020 - The European Higher Education Area in the new decade" (28-29 April 2009), emphasized lifelong learning as a priority area for the development of European higher education [2]. This is the answer to the challenge of modern time - the fullest disclosure of the talents and abilities of the adult population. Comparison of the European reference framework of key competences for lifelong learning in 2006 and 2018 concludes that the essence of competences has been transformed [3] and also indicates a very slow implementation of the lifelong learning direction in Ukraine. Therefore, the state policy in this country in the field of higher education highlights, first of all, the development of the following areas: 1) quality of education; 2) integration into the European higher education and research area; 3) lifelong learning. The latter direction is realized by [4]: recognition of non-formal and / or informal education; development of postgraduate academic (pedagogical) education; the new architecture of the postgraduate education system.

An important prerequisite for the implementation of the abovementioned directions is the change of the encyclopedic approach and the use of a competency-based approach [5], which contributes to the formation of personal characteristics of a human being for living in the modern world, gives the opportunity to use knowledge and skills in various professional and life spheres and defines the most important competences of modernity in the common European educational area – so called "key competencies".

Competence is a specially organized, dynamic combination of knowledge, skills and attitudes which develop throughout life with the help of formal, non-formal, informal education and enables to socialize, realize, and express a person in society in a creatively and effectively. Competence involves obtaining an assessment or actual result, which is achieved through a combination of knowledge and skills with the person's way of thinking, his attitude, values, ideas and experience [6]. The updated European reference framework for key competences for lifelong learning (2018) emphasizes the innovative idea of the cross-cutting of key competences in a coherent educational space which combines formal, non-formal and informal education [5].

The data science analysis provided by Google Trends, allows us to track the main trends of scientific development and the level of interest of the scientific community in the field of cultural awareness. The dynamics of search queries show a range of issues related to the concept of cultural awareness, and the countries where the topic (or closely related subject) is mostly being studied: intercultural competence: Australia (100 thousand); Germany (82 thousand); Uzbekistan (60 thousand); defining standards of cultural competence: National Association of Social Workers, USA; developing competencies in the field of intercultural counseling through a systematic approach: USA; creation and implementation of cultural projects: Ukraine; cultural project management: Russia.

Topics of publications examining cultural awareness are related to the concepts of "national" and "cultural identity" of a person [7], which is determined by the commonness of the cultural horizon, through which the possibility of cultural and historical knowledge appears, and a special way of perceiving the existence of a human being and the world is created - a real "hermeneutic universe" in which a person is not closed, and to which he or she is opened [8]. The main focuses on cultural identity include higher education (University), as well as understanding of the university mission at the "temporal crossroads" (learning as

knowledge transfer from the past and research in order to gain knowledge from the future) and "spatial crossroads" (nationalization at the stage of the nation-states formation and internationalization in today's global context) [9, p. 16]. This is a condition for creating a personality of a certain cultural type which is capable to act in all directions and shape "education".

Lifelong learning helps build an individual trajectory of learning that requires self-direction, self-determination, as well as awareness of one's own qualities and capabilities [10].

Scientists are developing scales for measuring the propensity to learn over the lifetime, which is related to the level of gnoseological beliefs [11], self-esteem of self-learning [12]; ability to learn throughout life as a separate element of professionalism [13].

The definitions of cultural awareness related to various fields of economics, thinking, foreign language, inclusion are of particular interest to our study. Thus, the development of cultural awareness occurs on the verge of philosophy, philology, cultural studies, history, psychology, and therefore requires an interdisciplinary approach [14]. This has led to the interest in studying the state of cultural awareness of academic and teaching staff of different fields of specialization, because the cultural and humanistic dimension of scientific knowledge expands the cognitive abilities of the individual and promotes his spiritual development. So the purpose of the study is to highlight the accents of cultural awareness in the context of lifelong learning at the example of high school academic and teaching staff.

According to the purpose the following tasks were formulated: 1. To identify the components of cultural awareness. 2. To analyze and characterize the factors which contribute to the development of cultural awareness. 3. To describe the tasks for the self-development of high school academic and teaching staff and development of their cultural awareness.

To achieve this purpose the following research methods were used: studying the scientific and theoretical basis of cultural awareness, theoretical analysis and comparison of the state of the defined problem development; methods of theoretical generalization of the issue of cultural awareness formation, empirical study of the present state of cultural awareness of high school academic and teaching staff.

Main research material.

Cultural awareness refers to the next knowledge, skills and attitudes:

- knowledge of local, national, European and world cultures, including languages, heritage, traditions, cultural products;
- understanding the various ways in which ideas, between the creator, the participant and the audience can be conveyed in written, printed and digital texts, theatrical performances, films, dances, games, art, design, music, rituals and architecture, as well as in hybrid forms;
- skills that imply the ability to express and interpret figurative and abstract ideas with the imagination, to experience emotions in various fields of art and forms of culture;
- cultural awareness implies an openness to and respect for the diversity of cultural expression, for ethical standards and responsibility for intellectual and cultural property;
- positive attitude includes interest to the world, openness, willingness to participate in cultural experience;
- cultural awareness includes contemporary digital forms of cultural expression, intercultural awareness and a global perspective [15].

The realization of key competences in Ukraine is also provided for by the New Ukrainian School concept, in particular awareness and self-expression in the cultural sphere is defined as the ability to understand works of art, to form their own artistic tastes, to independently express ideas, experiences and feelings through art [16]. This competence requires an understanding of one's national identity as a basis for an open attitude and respect for the diversity of the cultural expression of others.

Adoption of the New Ukrainian School concept leads to changes in the content of determining the mandatory competences of a bachelor's degree: to preserve and enhance the moral, cultural, scientific values and achievements of society on the basis of understanding of the history and regularity of development of the subject area [17].

Content of cultural awareness helps ensure:

- knowledge of philosophical, cultural, socio-cultural, moral and ethical content;
- availability of skills for the implementation of cultural projects, initiatives, community, volunteering, educational cultural activities to provide lifelong learning;
- formation of values, attitudes, mindset: general cultural, national, civic, moral, ethical and scientific.

The content of cultural awareness provides an opportunity to determine its components:

- 1) linguistic component (knowledge of native, national and foreign languages);
- 2) intercultural component (general information about geographical location, natural conditions, basic categories of different cultures, system of values, ethnic and cultural settings, features of verbal and non-verbal communication);
- 3) sociocultural component (mentality, state system, historical peculiarities and cultural traditions of the countries, willingness to participate in modern cultural events);
- 4) personal component (barriers, motivation or unwillingness to master a foreign language, respect for the values of different cultures, ability to reflect).

The relevance of these components, in our opinion, is determined by the situation of integration into the European space, understanding and acceptance of European values.

During the conducted research 50 representatives of academic and teaching staff of 10 Kyiv higher educational institutions have been interviewed. The group of respondents aged 30 to 70 consisted of the representatives of the humanitarian direction – 27 persons (including foreign language philologists – 10, socio-political direction – 5, law – 4, economic – 8), and technical direction – 23.

The research results on the linguistic component show a high level (67%) and medium level (33%) of mastery of the language culture. Most academic and teaching staff (73%) speaks foreign languages (12% of them are not philologists); those, who do not know any foreign language – 27% – represent different directions.

Respondents are more likely to experience positive emotions when learning a foreign language: satisfaction - 50%, and interest - 67%, astonishment - 3%, 9% respondents feel negative emotions, 3% - irritation. As a motivation for learning foreign languages by academic and teaching staff the next factors were mentioned: competitiveness (70%), participation in international projects (27%), work with foreign scientific literature (27%). Motivations related to personal preferences include: traveling, learning the new facts about the world, reading fiction, watching movies, having a wish to interact with foreigners, striving for self-improvement, and developing cognitive abilities.

Thus, 50% of academic and teaching staff, not foreign language teachers, knows foreign languages, and it is the sphere where the language teachers show the self-improvement and development of cognitive abilities as a significant motivation. At the same time, the common motivation for language learning is competitiveness, participation in international projects, and the need to work with scientific literature, which speaks about the tendency of modern high school teachers to enter the international level, and the pursuit of academic mobility. In the context of cultural awareness, the level of development of the linguistic component is related to professional scientific activity, but is not manifested in pedagogical activity, is not used or little used in the teaching of disciplines.

The study of the intercultural component of cultural awareness of academic and teaching staff revealed the existence of cultural focuses aimed at gaining new experience on different cultures, the desire to communicate on the international level, the desire for self-improvement and the expansion of the range of interest. According to the respondents, the important qualities that contribute to the development of the intercultural component are self-esteem, communicative abilities, tolerance towards other cultures, as well as the presence of cognitive interest and professional ambitions (see table 1).

Table 1. Summary table of intercultural awareness based on the results of academic and teachers staff survey

	Questions that determine the component of cultural awareness	Survey results
Intercultural component	What do you think helps you gain your own cross-cultural experience?	Cultural mindsets: - gaining the new experience, - desire to communicate, - desire for self-improvement, - expansion of the range of interest
	What do you think hinders high school teachers from understanding other cultures?	
	What influenced your interest in other cultures?	
	By what means and personality traits, does your cultural expression happen?	Personal qualities: - self-esteem, - communicative abilities, - tolerance towards other cultures, - empathy, - cognitive interest, - professional ambitions
	What personal traits contribute to intercultural understanding and communication?	
	Rate on a scale of "0" to "3" how much the material at the lessons includes the achievements of European and world cultures.	Application of intercultural component in the educational process: - use of materials of intercultural artistic or inclusive practices and projects, - ability to understand, comprehend, and explain the diversity of cultural achievements
	Rate on a scale of "0" to "3" your own ability to understand and explain in various ways the transfer of ideas between creator, participant and audience in written, printed and digital texts, theatrical performances, films, dances, games, art, design, music, rituals and architecture, as well as in hybrid forms.	

However, according to the survey, we can conclude that there is a low level of use of cultural awareness and self-improvement of the teachers when teaching subjects. Also, the rapid increase of the of teachers' interest in other cultures during the COVID-19 quarantine (online participation in international projects, cultural events), which are not directly related to professional activities, may be explained by the availability and the compensatory function of cultural awareness in the context of uncertainty.

The socio-cultural component is represented by the factors that contribute to or hinder the development of cultural awareness of higher education teachers. Thus, according to the survey, the presence of motivation for self-improvement, a focus on lifelong learning and knowledge of foreign languages, and a focus of teachers to the preservation of Ukrainian sacred values of a family, in which cultural and national identity are manifested, are the factors that help to gain cultural experience. Availability of free time, the ability to travel as well as the ability to communicate with representatives of different cultures were indicated as the necessary conditions.

On the contrary, lack of free time, overloading, and insufficient funds are the common factors that lead to lack of interest and limitation of interests exclusively within the scope of professional specialization. This is evidenced by the low involvement of teachers in cultural projects and activities (6% - cultural project managers, 8% - project implementers, 2% were cultural events observers).

An important task was to investigate the meaning of the respondents' participation in cultural projects and activities. According to their answers there were roughly marked out three groups of teachers. The first group includes respondents who did not answer this question at all. In addition, they did not participate in cultural projects, showed a low level of interest in cultural life, not directly related to the specialist's specialty, attended cultural events at a frequency of 1-3 times a year. It is quite clear that they answered the question of using the artistic practices and artistic information in the educational process negatively. Teachers are aware of their unwillingness to engage national, European and world cultures in their teaching activities.

The second group of respondents sees the meaning of participation in cultural projects and activities in "learning about the new", "self-development", "self-improvement", "unlocking one's own potential", "growth". However, the teaching process they show a low level of activity regarding the use of experience of artistic practices, involvement of cultural figures and use of modern information and communication technologies.

Respondents of the third group see the meaning not only in self-improvement, but also as a teacher's mission - transfer of cultural experience, values, creation of a spiritual center. This is connected with the fact that higher educational institutions stimulate activity, provide opportunities for participation in cultural events of national European and world level. It is interesting that these teachers (aged 46 years) expressed the meaning of participation in cultural projects, such as "involving young people into the cultural heritage of humanity", "understanding the social importance of the profession of a teacher", "spreading and preserving the spiritual values and cultural traditions of the nation", "self-realization and self-expression through culture".

A significant role in the development of cultural awareness is played by the personal component, which is reflected in the subjective assessments of the proposed areas: 1) the

importance of supporting and creating conditions in the higher education institution that promotes teacher's self-development and self-expression; 2) personal traits that influence adaptation and socialization in new cultural environments; 3) the value of national traditions.

The results of the evaluation of support and participation of the university in the process of organizing the conditions for the cultural awareness development on a 10-point scale are as follows: the lowest rating "1-3 points" was found by two people; the highest score "9-10 points" – was given by nine people; the largest group consists of thirty nine people who rated the organization activities at their institutions at "7-8 points". Thus, working conditions in higher education institutions can be considered as satisfactory. This data reveals a contradiction between subjective satisfaction of the support and participation of the universities in creating the conditions for the development of cultural awareness and the real participation in cultural projects and activities.

The personality traits that influence academicians' adaptation and socialization to new cultural environments most of all are: openness, communicativeness, flexibility, and tolerance for uncertainty.

In our opinion, the diversity of national traditions of one's own country also influences on the development of valuable attitude and cultural awareness of a person and enables to express oneself. According to the results of the survey, the respondents noted the most valuable tendencies for them are: 1) traditional holidays with the accent on the family values; 2) traditions that emphasize national identity, including Ukrainian cuisine, embroideries on clothes, the most popular customs; 3) sacred rites. Thus, the results obtained indicate that the personalities of the respondents are directed towards preserving the Ukrainian sacred values of the family in which national identity may be manifested.

The development of the cultural awareness components is influenced by the level of personal component formation. The latter permeates all spheres of professional and personal life, while at the same time changing itself under the influence of culture, due to the desire for self-improvement and the ability to self-determination. The peculiarity of the development of the personal component of scientific and pedagogical staff is the synergy of scientific activity and cultural awareness, in which we can see personal resources and potentials for self-expression and self-realization, because a person is able to make the informed choice. In this sense science can be considered as a part of the cultural phenomenon.

As the important conditions for developing the personality traits of high school teachers and which influence upon the developing the cognitive interest, motivate to gain knowledge of the world and respect other cultures, while maintaining the teachers' own identity, we see the next:

- commitment to preserve the sacred values of the family and family in which national identity is manifested;
- an eco-social and psychologically safe space for opportunities and free access to communication and exchange of experience with other cultures and practices;
- support and participation of the higher education institution in creating conditions for the development of cultural awareness, self-realization, as a process of self-expression, accompanied by creativity;
- presence of such personal qualities as: openness, communicativeness, flexibility, tolerance, readiness for uncertainty.

At the same time, respondents consider as the most important condition - having their own personal qualities, which indicate the orientation of a person to self-realization. However, the maturity of the willingness to act independently for the knowledge of the Other, the other world, and the culture is not manifested enough. This can testify to the narrowness of the view and the lack of a holistic perception of the world and nature of a human being. Studying the current state of the components of cultural awareness of academic and teaching staff of higher educational institutions allows us to formulate the tasks for their possible development:

- 1) to promote the development of cultural and national identity, preserve and popularize the values of Ukrainian culture, language, traditions;
- 2) to form an understanding and respect for the achievements and values of other cultures;
- 3) to form responsibility for the preservation of cultural heritage and national culture;
- 4) to promote the development of an active life position through the extending and application of artistic practices, achievements of national culture as well as achievements of other cultures;
- 5) to promote the development of a cohesive and inclusive society by improving intercultural understanding, applying innovative and inclusive practices, supporting national and European initiatives.

Conclusions.

Thus, by cultural awareness we mean the ability to understand and respect to the ways how ideas and meanings in different cultures are creatively expressed and transmitted through different fields of art and forms of culture. Cultural awareness in the context of lifelong learning is determined by the level of development of linguistic, intercultural, socio-cultural and personal components. Cultural awareness and self-expression are the key competences, the development of which is enhanced by the academician's personality traits - openness, communication, flexibility and tolerance for uncertainty.

There were identified the factors that contribute to the development of cultural awareness of academic and teaching staff of higher educational institutions: 1) cognitive factors (knowledge of languages, development of mother tongue culture); 2) value factors (preservation of national identity, respect for the achievements of other cultures, development of personal qualities that promote motivation, interest to other cultures as well as the national one); 3) behavioral factors (creating the conditions for cooperation and communication with representatives of other cultures, obtaining free time for cultural experiences). It was also defined the task for developing the cultural awareness of high school teaching staff contributing to the self-determination of the individual. We see the challenge for further research in exploring the conditions for developing cultural awareness as opportunities for self-expression in inclusive education.

References

1. Drotianko, L.H. (2015). Science as a Phenomenon of Culture in the Philosophical Heritage of S. B. Krymskyi. *Visnyk NAU. Seriya: Filosofiia. Kulturolohiia*, 2 (22), 10-11 [in Ukrainian].
2. The Bologna Process 2020 – The European Higher Education Area in the new decade: Communiqué of the Conference of European Ministers Responsible for Higher Education. (2009, April 28-29). Retrieved from: <https://www.eurashe.eu/library> .

3. Commission Staff Working Document Accompanying the Document Proposal for a Council Recommendation on Key Competences for LifeLong Learning. (2018, January 17). Retrieved from: <https://eur-lex.europa.eu/legal-content/EN/TXT/?uri=SWD:2018:0014:FIN>.
4. Pukhovska, L. (2010). Lifelong Learning as a Priority Area of the Bologna Process for the Next Decade. *Osvita doroslykh: teoriia, dosvid, perspektyva*, 2, 77-84 [in Ukrainian].
5. Lokshyna, O.I. (2019). European Reference Framework of Key Competences for Lifelong Learning: an Updated 2018 Version, *Ukrainskyi pedahohichnyi zhurnal*, 3, 23-24 [in Ukrainian].
6. Law 2145-VII "On Education". (2017, September 5). *Verkhovna Rada Ukrayiny*. Retrieved from: <https://zakon3.rada.gov.ua/laws/show/2145-19> [in Ukrainian].
7. Kryvoruchka, L. (2014). Main features of the hermeneutical experience of cultural and national identity. *Tertium non datur: problema kulturnoi identychnosti v literaturno-filosofskomu dyskursi XIX-XXI st.* Retrieved from: <http://ekmair.ukma.edu.ua/handle/123456789/10860> [in Ukrainian].
8. Gadamer, H.-G. (2000). *Hermeneutics II. Truth and Method. (Vol. 2)*. Kiev: Junivers [in Ukrainian].
9. Kurbatov, S. (2011). Historical Transformations of University Mission. *Liudynoznavchi studii. Filosofiia*, 24, 16. Retrieved from: <https://core.ac.uk/download/pdf/32308206.pdf> [in Ukrainian].
10. Boyer, Stefanie L., Edmondson, Diane R., Artis, Andrew B., & Fleming, David. (2013). Self-Directed Learning: A Tool for Lifelong Learning. *Journal of Marketing Education*, 36, 1, 20-32. DOI: 10.1177/0273475313494010
11. Bath, Debra M., Smith, Calvin D. (2009). The relationship between epistemological beliefs and the propensity for lifelong learning. *Studies in Continuing Education*, 31, 2. DOI: 10.1080/01580370902927758.
12. Williamson, Swapna Naskar. (2007). Development of a self-rating scale of self-directed learning. *Nurse Researcher*, 14, 2, 66-83. Retrieved from: <https://journals.rcni.com/nurse-researcher/development-of-a-selfrating-scale-of-selfdirected-learning-nr2007.01.14.2.66.c6022>.
13. Veloski, J., & Hojat, M. (2006). *Measuring Specific Elements of Professionalism: Empathy, Teamwork and Lifelong Learning*. In D.T. Stern, (Ed.), *Measuring Medical Professionalism* (pp. 117–147). Oxford, New York.
14. [10] Kaniuka, I., Serdiuk, L. (2018). "Language Coach" – a Tool for Forming and Developing Cross-cultural Competence. *Open educational e-environment of modern University*, 5, 123-132. DOI 10.28925/2414-0325.2018.5.123132 [in Ukrainian].
15. Skills-based Education: a Leadership Module for Executive Staff. (2018). Retrieved from: <http://dlse.multycourse.com.ua/ua/page/15/53>
16. New Ukrainian School Concept. (2016). *Ministerstvo osvity i nauky Ukrainy*. Retrieved from: <https://www.kmu.gov.ua/storage/app/media/reforms/ukrainska-shkola-compressed.pdf> [in Ukrainian].
17. Methodological Recommendations for the Development of Higher Education Standards. (2017). *Ministerstvo osvity i nauky Ukrainy*. Retrieved from: <https://mon.gov.ua/storage/app/media/vishcha-osvita/rekomendatsii-1648.pdf> [in Ukrainian].

Ihor Proshukalo*Organizational psychologist**PhD student at the Department of Management Psychology**State Institution of Higher Education «University of Educational Management»**Kyiv, Ukraine**orcid.org/0000-0002-9878-7010*

CUSTOMER ORIENTATION OF THE PERSONNEL AS PHILOSOPHY OF ORGANIZATIONAL CULTURE FOR THE MODERN SERVICE ORGANIZATION

Abstract. *The companies organizational culture in the field of services reflects the specifics of this industry namely the service values which are the basis of both the regulatory system and symbolic due to the needs, goals and objectives of the service organizations. Therefore, the organizational culture of the companies in the service industry should be studied based on its service values. The service values of such companies are the customer orientation, customer trust, service quality and special service relationships. Of particular note that the disclosure of the concept "customer orientation the staff" as service value which is currently little studied in the context of psychological science and more in the field of economics. As result of this theoretical study, the role of customer orientation the staff as an important value in the system of forming the philosophy of organizational culture modern service organization. The concept of customer orientation the staff was analyzed from three aspects such as professional, social and personal. Each aspect it is the some complex which is represented by several components that are interconnected.*

Introduction.

At the present stage in the economic development of the Western countries continue growing the role of the service industry which is the leading sector of economy in Ukraine also and it is the most important area of the social life. The service industry is the generalized category which includes the various types services providing by the enterprises, organizations and individuals, and the result of their work is the service which is the product of labor, the purpose of which is to meet the specific needs of the consumers.

Currently, the organizations which works in the field of the service industry covering hundreds of the areas which are related with the human activities, providing its life, leisure, work and comfort. With the development of the market relations and the emergence of free market competition, the service companies pay more attention to the quality of the service and they focus on the market requirements because today the service industry is characterized by dynamism, variability, continuous emergence of new and new services.

Increased competition in the business, emergence of the new concepts that improve the quality of the workforce, such as quality management, knowledge management, management of the key professional competencies lead to change in building the relationships in the service industry. Its growing importance is due to the transition to the service economy, where the stakes are on the "man". Management of the modern service organizations involves certain purposeful activity to create a positive image, the formation of an appropriate organizational environment, the approval of the new standards service quality where an important role in this process is played by the organizational culture.

Currently, the market for services is changing and it is characterized by an excess supply of similar services. The client in the current situation chooses not so much the specific service as the organizational culture of the organization that provides this service. There is an urgent need to create a service organizational culture that will create the competitive advantages in the modern conditions. And customer orientation of the staff becomes one of the main factors in the competitiveness of the organization.

To create a competitive advantage, it is currently not enough to provide the products and services of the required quality, it is important to establish and maintain the long-term relationships with the customers. A special role in achieving this goal is played by the staff of the organization, because itself the staff interacts with the customers.

One of the most important factors in the successful operation of the service industry is understanding of the customer motivation, which is necessary competitive condition today. The provision of the services should be organized and offered to the customers in such way as to fully meet their needs and expectations. For this you need to establish the personal, individual approach to the client, which is expressed in a positive attitude towards the client in the desire to help the client in solving his problem and "to be for the client", the desire to work with people. All this forms the core of the customer orientation.

1. Customer orientation of the personnel

The concept of "customer orientation" is firmly entrenched in the modern business vocabulary, today it is often used in the context of the separate business process of the company, sometimes as their key element. However, the modern market conditions encourage the transformation of this concept from a single element to a whole philosophy of the company organizational culture. The essence and features of the customer-oriented approach are reflected in the research works of the foreign scholars such as Friedemann W. Nerdinger, Martin Lindstrom, Don Peppers, J.C. Thomas, which reveals the essence of the customer-oriented approach and the main components of the modern business.

As for the domestic scientists, our analysis of the literature shows that the problem of the customer orientation is much less reflected, first of all, it is presented in the works of the economic profile as Hrechanyk, N.Iu., Deineka, O., Dzhodzhua, R.A., Dyma, O.O., Krush, P.V., Pylypchuk, V. P., Sharapa, O. M. If we talk about the psychological aspects of the staff customer orientation in the modern service organizations, they remain virtually unexplored.

Today, the customer-oriented approach is increasingly becoming the leading paradigm of doing business. This is due to the unique competitive advantages that are quite difficult to create with the new technologies, because the attitude to the customer is much harder to copy and therefore only knowing your customer, understanding his needs and anticipating his potential desires and based on customer psychology, you can create a product or service that cannot be refused. This in turn leads to increase the loyalty of existing customers and attraction of the new ones, and in accordance with the growth of profitability and long-term prosperity of the enterprises. In this regard, it becomes important to track the measurement of the customer needs, focus on increasing the consumer value of the products and services, training of the customer-oriented staff [1]. Unfortunately, in the scientific literature today there is no clear definition of the staff customer orientation. For example, Panov, D. notes that the customer orientation of the staff is when the client left satisfied. The customer satisfaction depends on the smallest details, namely how you were greeted, how they smiled, how they served you, what the interior was like, what other visitors and staff look like, what music played and more [2].

Shikunova, N. notes that customer-oriented staff is the staff for whom the value of the client is the main one. Tschohl, J. does not offer a definition also, he points out that client-oriented employees those who love and respect people, as well as have such qualities as motor skills, sociability, enthusiasm [4]. That is, in general, the researchers note only the certain general characteristics of the staff and their behavior, but do not give an accurate definition of the customer orientation.

The customer orientation is the certain concept that proclaims the primacy of those principles of meeting the customer needs, meeting their expectations, anticipating their desires in all areas of the organizational activity [5].

Let's consider the concept of the "customer orientation" more detail through the following aspects such as professional, social and personal. From the point of view of the professional aspect the employee of the service organization has to solve the problem of the client which has compelled it to address for service in the company. In the context of the professional aspect, an important professional component is the professional competence of the specialist in the field of the service, which includes the following components as professional knowledge, skills and abilities.

The professional knowledge is necessary for the successful operation of the service specialist. They cover information about the objects of the work (Clients), technologies for the implementation of the services, data on all determinants that determine the success in achieving the desired results. The professional skills are the actions and methods of work the service specialist. He needs to analyze the real conditions of the activity, goals and needs of the customers, plan and effectively carry out work on the implementation the services in accordance with the customer requests.

The skills reflect the acquired ability of the service specialist to perform the professional actions (here we can highlight the ability to regulate their mental activity and emotional state). To do this, he must have some knowledge that has been acquired with experience, in particular, the certain principles of working with the customers, customer service technology, the methods of establishing and maintaining the relationships. In addition to the knowledge, we also talk about certain skills as an element of the professional activity that allows the employee to perform work well, for example, the sales specialist must have basic skills such as establishing contact, clarifying the customer needs, the ability to recognize and consider the individuality of each client the objections and claims, termination of the contact. We can also highlight such professional action as a habit that is formed by repetition and it is characterized by the high degree of development, automation and skill to quickly identify and meet the customer requests. Thus, in establishing and maintaining the relationships with the clients, the skills of active listening, using the techniques of the small talk, etc. are important.

For professional solution of the clients problems the personal contact seller of the service with the client is necessary, and therefore we can speak about the following aspect as social which is realized through the conative component such as behavioral readiness for certain type of the communication in the context of the service relations between the employee of the service organization and the client in order to satisfy the last one.

The behavioral readiness is an attitude that is considered as the intention, the readiness of the employee service organization to th certain way of activity. The attitudes are the universal determinants of the employee socio-professional behavior and reflect his attitude not to the specific, personalized and important to him personally client, but to the consumer environment as whole. These attitudes are formed both on the basis of the individual's personal perception of the "service philosophy" and on the basis of the norms and requirements for the social standards of the professional activity proposed by the company's management.

The human behavior is set of the actions that person performs when interacting with the social environment. In general, this complex, multifaceted phenomenon includes the assessment of the situation, the forecast of its development and the development of the appropriate action. Interacting with the client, the employee of the service organization solves a number of the social - professional tasks such as assessment of its own awareness of the customer requests, choice of to approach to the client (establishing contact), defining its own behavior in such way as to gain the client's trust to themselves.

The social roles whom the person performs in life is greatly influenced for human behavior. The social role of the service employee is set of the certain rules conduct ("rules of the game") adopted at particular service company [6]. In performing any social role, the person acts according to the certain program, which can be contained in the official documents or enshrined in the traditions and customs.

In the context of the social aspect, we find interesting the theory of Andrieievoi, H.M. [7], who proposed to divide communication into communicative component (information transfer), interactive (organization of interaction), perceptual (people's perception of each other).

Based on this theory, we can assume that behavioral readiness, which we have defined as readiness for the special type of communication is revealed through readiness for communicative, interactive and perceptual communication.

The appropriate social behavior is manifested in the process of communication with the client and a certain set of the employee actions service organization, which are aimed at establishing and building both short-term and long-term relationships with the client to obtain the desired result. It is worth noting that even if the employee may have all the necessary knowledge about the service, skills and abilities in the field of the service, but if his social behavior is not aimed at meeting the needs of the particular client, the likelihood of building the necessary relationship with him decreases.

Observance of the certain social standards by the employee in the behavior depends not so much on the received the professional qualification (concerning performance of separate working functions), how many on personal qualities of the employee, his moral attitudes. After all, not everyone is able and willing to work with other people. And if the employee's perception of working with the client causes him positive emotions and there is convincing feeling that the client deserves excellent service, then accordingly comes the personal aspect that is manifested through the cognitive, emotional and motivational component.

The personal qualities of employees service organizations play an important role in working with the customers because they create an appropriate basis for the social behavior, and in this case we are talking about the close relationship between the social and personal aspects of the customer orientation. In the context of the personal aspect, the main process of the cognitive component is understanding. Understanding the current emotional state of the client, his needs, intentions, his attitude to the service. Without the process of understanding, the provision of services ceases to perform its main functions as customer satisfaction, creating conditions for customer satisfaction with the service. The basic mechanisms of understanding are identification, empathy and reflection.

The employees of the service organization who build their relationships with the customers through the above mechanisms are more likely to respond emotionally to the customer problems and needs, mentally take their place, understand how the service is perceived by the customer than those who do not have such mechanisms of understanding.

The emotional component is very important in the work of employees service organizations because it is the same process in interpersonal communication which is manifested through empathy, emotional resonance and gives some meaning to concepts such as "being with the client" and "being for the client". The important element of the emotional component is the emotional stability of the employee. When the employee is confident, externally and internally balanced, determined in decision-making and has a high level of stress. These characteristics are closely related to the social behavior of the employee service organization and they are manifested in the emotional relationship between the employee of the service and the client as close in direction and intensity of the emotional states people in personal interaction.

The corporate culture specialist Chernyshov, B.N. [8] introduces the concept of emotional work which is defined as the act of expressing the socially desirable emotions in the course of the service relations between the service employee and the client.

Some type of activities require from the service workers to act in friendly manner towards the customers or for them to express sympathy and be modest, while others require concentration, impartiality, scilicet the expression of emotions that can be conveyed through the facial expressions or gestures. The problem is that the employee may not actually feel such emotions and act accordingly. The employees who are in constant contact with the client, follow the so-called "rules of the show" both through action and through the expression of spontaneous and genuine emotions. The "rules of the show" reflect the norms imposed, firstly by the society (and they may change, for example, in different national cultures), secondly, by the certain kind of occupation, thirdly, by the organizational cultures of the individual organizations, and finally they reflect the nature of the specific service relationships, which are characteristic and spontaneous for the service organizations.

Today in the theory of the human relations Levit, H. & Bakhrami, H. [9] widely discusses the importance of emotions for the formation behavior. It is believed that the emotions caused by the situation underlie the behavior. The images generate emotions, as can be seen from numerous examples of communication, but emotions are partly formed from our certain systems of the ideas and justifications.

This determination is related to the organizational culture of the company, which is a "reservoir" of the ideas, although not the only one because the person has received its own education and experience. But, forming the set of ideas that are shared in the organization, the organizational culture is involved in shaping the behavior of its employees, and therefore often viewed through the prism of the typical behavior of its members.

One of the difficulties in analyzing the person's professional activity is that the subject himself often does not realize what exactly is his motive. In the zone of his consciousness there is only an idea of what to strive for at this stage of activity. The conscious image of the intermediate result in psychology is called the goal, and the stage of activity corresponding to this image is called action. The subjective significance of each individual action, its meaning is determined by the extent to which the corresponding goal is consistent with the motive of the whole activity. The higher agreement, the greater semantic load of the action. If the organizational culture of the organization is one where there is conscious control over those stages of activity, the analogues of which are constantly encountered in practice and which are well mastered (professional skills), then these stages are organized on the subconscious level, and we are dealing with this type of activity as operations.

The motivational component is the main stimulus for appropriate social behavior of the employee the service organization.

The motivation appears only when the employee in the situation with the client gets the opportunity to meet their own needs and certain goals that are important for the employee.

In general, there are internal and external motivation.

The internal motivation it is the motivation which is associated not with the external circumstances, but with very content of the activities. The person works because he is interested in the tasks that arise in the process of professional activity and it brings him pleasure. While external motivation is the motivation or coercion to do something external to the person or circumstances, such as making a career, to earn as much money as possible.

The employees who are focused on working with the clients have strong internal motivation which is manifested on the three levels: perception of working with the client as an important part of their own professional activities; sense of responsibility for the results of their own work; tracking the effectiveness of their work especially in the context of its quality. However, for this the company must provide certain conditions for the development of internal motivation of the employees at these three levels: variety of the professional tasks that help employees to realize their experience, skills and abilities; the professional tasks should be comprehensive in order to be fully involved in the service delivery process, and not just, for example, to receive orders and complaints; the importance of performing the professional task to ensure the life and work of other employees, customers, contributing to achieving the company's goals; autonomy of the employee, which means that the employee can take some professional responsibility in the independent choice of the tools, independently set goals and make decisions within their, of course, professional competence; the feedback is a connection that an employee constructively receives from the company to correct their own mistakes and to understand which stage of achievement he is at. For employees who work directly with the client, an important source of feedback is the client himself, who does not always provide such feedback, and therefore it is important for the service employee to be able to receive such feedback to improve their professional level in the customer service.

The important result of the motivational component is a high level of internal motivation of the employees which helps to improve not only the quality of the employee work but also to get pleasure from this work from the employee.

Thus, analyzing each aspect, we can define the customer orientation of staff as the set of professional knowledge, skills and abilities that, due to the appropriate motivation and personal qualities of the employees contribute to their certain social behavior to establish and maintain relationships with the customers, getting the desired result.

2. Organizational culture of the modern service organization

Today it does not need the proofs to study for the specialists in various fields of knowledge such as the economists, psychologists, sociologists and philosophers not only the concept of the customer orientation but also the ways of its successful development, in particular, in the context of the organizational culture service organization. In this theoretical study, speaking about the specifics of the organizational culture of organizations in the field of service, we turn to those factors that determine this specificity in contrast to other areas of activity.

The problem of the organizational culture has been the subject of the special researches by the Western researchers (Daft, R., T. Deal, Cameron, K., Quinn, R., Lewis, R., Ouchi, W. & Schein, E.) and last years has been actively studied by the Ukrainian scientists. Each of them

studied the individual manifestations of the organizational culture in the various spheres such as industry (Zakharchyn, H., Kalinichenko, T., Karamushka, L., Sniadanko, & I., Kharchyshyna, O.), business (Ovcharenko, A., Stanislavska & M., Frantsev, O.), university (Apisheva, A., Zavatska, N., Ishchuk, O., Mitichkina, O., Spitsyna, L. & O. Bondarchuk, O.), public service (Baraniuk, N., Korol, O., Malimon, L. & Okhotnytska, K).

The organizational culture is a competitive advantage of the enterprise as much as it is a generally accepted, consistent, holistic system of the perception, values, approaches and definitions [10]. Michael Armstrong argued that organizational culture is set of the beliefs, attitudes, norms of behavior and values common to all employees of the organization. They can not always be clearly expressed but in the absence of the direct instructions determine the mode of action and interaction of people and significantly affect the course of work [11].

We can not disagree with Edgar H. Schein's opinion that organizational culture is set of the basic beliefs formed independently, assimilated or developed by certain group as the group learns to solve the problems of adaptation to the external environment and internal integration, which proved to be quite effective and considered valuable, and thus passed on to new members as the right way to perceive, think and relate to the specific problems [12].

Michael H. Mescon interprets the culture as a climate in the organization which reflects the customs inherent in the organization [13].

Under the culture of the organization should be understood as a unique set of the norms, values, beliefs, patterns of behavior that determine the way groups and individuals are united in the organization to achieve its goals are defined by J. E. T. Eldridge and A. D. Crombie [14]. The above definition of the organizational culture complements W. Ouchi. In his opinion the organizational culture are the symbols, ceremonies and myths that communicate to the members of the organization important ideas about the values and beliefs [15].

According to O.B. Morhulets: "the organizational culture is the system of the values and beliefs that gives the members of the organization awareness of its tasks and provides them with the rules of conduct in it" [16]. Among the subjective elements of the organizational culture are "values" which are understood as the properties of the certain objects, processes and phenomena that have an emotional appeal to most members of the organization.

The values include, first of all, the goals, nature of the internal relations, the orientation of people's behavior, diligence, innovation, initiative, work and professional ethics, and others.

The key values combined into a system, form philosophy of the enterprise organizational culture which reflects how the company perceives itself and its purpose the main activities, creates basis for management approaches (style, motivational principles, information guidelines, conflict resolution), organizes personnel activity on basis the general principles, facilitates the development of the administration requirements, forms the general universal rules of conduct and its attitude to the employees and customers.

As for the service industry, the theory of management considers the culture of the service company basing its content on the principles and ethical standards of the customer service.

Thus, the culture of service is the organizational culture of the service company aimed at the customer service through development of the certain rules, procedures, practical skills and abilities. It is dictated by the company's policy, supported by system of the incentives for service personnel along with other activities [16].

The culture of service is important for development of any organization and for the company in the field of services, in particular, because it is the level of service culture directly shapes the image of the company in eyes of the customers themselves. Each service organization, building its organizational culture determines the hierarchy of the service values which is based on the characteristics of the service and its content and the degree of customer participation in the service, the degree of risk, the degree of staff participation and other characteristics.

According to L. Beitelshpakher, the culture of service in the organization should be understood as the customer-oriented culture that try to exceed the customer expectations and is mainly aimed at ensuring the highest value for the customers. [17]. And if, accordingly, the level of organization culture is high, then organization itself and its employees work as whole. However, it is worth noting that company with the high culture does not necessarily have the high culture of service. After all, high culture of the service encourages employees in their actions to focus on the customer and is the first step towards development of the customer-oriented organization.

Comparing organizational culture in general and customer-oriented organizational culture the researchers still find some differences. The specificity of the customer-oriented cultures consists of the customer-oriented values and behavior of both the company's management and its employees which is based on real desire to solve the customer problems, innovation and flexibility of employees in solving them. Such customer-oriented elements in the organizational culture are the key factors for successful development of modern company in the field of services.

For the service organization, the consumer of the service is the main value in their work because it is from him that the main information to the organization about the quality of service. And constant feedback from the customers can be positive incentive to improve the quality of service. This makes it possible to correct those service issues that company may never know about.

The customer service is sequence of the activities aimed at increasing the level of customer satisfaction namely formation the customer's sense of understanding and service which is provided in accordance with his expectations. The formation of the quality skills of service in employees of the service organizations indicates the presence of developed service organization culture as whole.

The service culture as special kind of culture within the broader concept of organizational culture is defined by Ch.Gronroos as "the culture where there is gratitude for good service, and where providing good service for both internal and external customers, and it is the natural way of life and one of the most important values "[18]. Based on this definition, the culture of the service applies not only to the activities of the organization but also the style of business, values and behavior of the organization and its employees. If the organization has strong service culture it will build the positive attitude of employees to provide the services to the customers.

O.B. Morhulets notes that today there is widespread understanding of service culture in the narrow sense as set of the courtesy rules (ethics of behavior). However, this concept should be considered much more broadly in all manifestations of its constituent elements. The culture of service is an integral part of the general culture of the enterprise, it reflects certain level of development (degree of perfection) of the service process which is expressed in psychological, ethical, aesthetic, organizational, technical and other aspects [16].

According to N.A.Antonova, service quality as service value in the context of organizational culture contains not so much technological characteristics as set of properties that determine the ability of the service to meet the emotional needs of the client.

N.A. Antonova identifies the following service values, which make up the quality of service such as real standardization of services, individual approach, reliability (performance of the service accurately and thoroughly), material culture (physical environment as design of premises, appearance of employees, etc.), sensitivity, empathy, professional responsibility, conscience, honor and dignity [19]. From the point of view of the humanistic values in the model of organizational culture of service organizations, taking into account the specifics of their activities, the value-motivational and socio-psychological characteristics of employees, such values as sensitivity, respect for others, self-esteem, intolerance of various forms of discrimination, tolerance and restraint, focus on mutual assistance and cooperation. That is, the organizational culture of the service organization is based on ideology, which includes understanding that emotional values have replaced the physical characteristics. The relationships are for sale so attachment to core values becomes the crucial factor for success. The service values are all images, relationships and abstract qualities that give service along with the functional characteristics.

The significance of the organization's activities in the field of service focus on the maximum customer satisfaction. The customer orientation becomes the main value, which, according to N.A. Antonova should include customer loyalty, which is based on the establishment of the long-term relationships based on mutually beneficial trust, when lasting advantage is created; the client's needs which dictate the topical question of whether the values offered by the organization are important to the consumers, focused on the sense of satisfaction that should arise from receiving the service; "human resource" because it is employees who transmit to the external environment the values of the organization transformed in their behavior; service mentality as not every service specialist becomes involved and committed employee of the service company. The purpose of corporate culture becomes stimulate the service mentality, which is determined by interests of employees activities aimed at "serving" the client [19].

Thus, the customer orientation of staff becoming the basis of organizational culture in the field of services in its purposeful and systematic formation and attention to development, acts as the main competitive advantage of the organization in this field of activity.

Conclusions.

The culture is the foundation of the relationships and, consequently, efficiency, because it forms an idea of interaction between group members. These ideas are partly basis of the actions, behavior because everyone acts according to their cognitive ideas.

The service sector reflecting and embodying the appropriate level of development of the society, given the current conditions of development of this area, it requires special approach to the organizational culture of the modern service organization, which in its activities is based on certain dominant values. The dominant values on which the organization is based and which are shared by employees and then transmitted to the environment through sign-symbolic system are able to form a philosophy of organizational culture that defines the meaning of the organization and its attitude to the employees and customers.

The customer-oriented staff as service value is filled with the certain meaning, when the value is the customer's needs, his loyalty and from so establishment of the long-term relationships. At the same time, because the service provider is part of it, the value is the commitment of employees includes their identification with the organization, involvement and loyalty. As the result, it creates a new worldview that aims to make the employees believe that they are working for the customers and not for their managers.

Today it is important for the service companies to manage the values and not the functional characteristics of the services, sales, and from so it to be able to form and build the organizational culture on understanding the content and importance of the values and to be able to convey to the employees how it should be manifested in their relationship with the customer. This requires the system with the set of rules, rituals which provide delivery of the values that underlie the service philosophy.

References

1. Prodan, I. O., & Riznyk, Yu. I. (2017). Customer - oriented approach as a prerequisite for enterprise competitiveness. *Biznes Inform*, 1, 308–313 [in Ukrainian].
2. Panov, D. (2006). Service Kings need to grow yourself. *Personal-Miks*, 7–8, 18 [in Russian].
3. Shikunova, N. (2006). It is impossible to force to love. *Personal-Miks*, 7–8, 23 [in Russian].
4. Shoul, D. (2007). Service is the horizon of modern business. *Marketynh.pro.*, 1-2 (28-29) [in Ukrainian].
5. Zagrebnoj, V. (2008). Customer oriented is the key to success in the insurance market in the face of fierce competition. *JeKSPERT*, 36, 62 [in Russian].
6. Fedcov, V. G. (2000). *Service Culture*. Moscow: PRIOR [in Russian].
7. Andreeva, G. M. (2000). *Social Psychology*. Moscow: Aspekt-Press [in Russian].
8. Chernyshov B. N. (2003). Personnel Management in the service organizations. *Upravlenie personalom*, 12, 24-26 [in Russian].
9. Tevene, M. (2003). *Enterprise Culture*. (V. A. Spivaka , Trans.). St. Petersburg: Neva [in Russian].
10. Kameron, K., & Kuin R. (2001). *Diagnosis and change in organizational culture*. (I.V.Andreevoj, Trans.). St. Petersburg: Piter [in Russian].
11. Khalet, H.L. (Ed.). (2003). *Corporate culture*. Kyiv: Tsentr navchalnoi literatury [in Ukrainian].
12. Shejn, Je. (2002). *Organizational Culture and Leadership: Building, Evolving, Improving*. (S. Zhil'cova, & A. Cheha, Trans.). St. Petersburg: Piter [in Russian].
13. Meskon, M.H., Al'bert, M., & Hedouri, F. (1998). *Management basics = Management*. (Trans.). Moscow: Delo [in Russian].
14. Eldridge, J., & Crombie, A. (1974). *A sociology of organization*. London: Allen&Unwin.
15. Ouchi W. (1981). *Theory "Z": How American business can meet the Japanese challenge*. MA: Addison-Wesley.
16. Morhulets, O.B. (2012). *Management in the field of services*. Kyiv : Tsentr uchb. l-ry [in Ukrainian].
17. Beitelspacher, L. S. Exploring a New Perspective on Service Efficiency: Service Culture in Retail Organizations. *Journal of Services Marketing*. 2011, Vol. 25, 3, 215-228.
18. Gronroos, Ch. (2007). *Service Management and Marketing: Customer Management in Service Competition [3 ed.]*. NY.: John Wiley & Sons.
19. Antonova, N.A. (2009). *Corporate culture in the service organizations*. Irkutsk: Irkutsk State University [in Russian].

Daria Kononova*PhD (in Linguistics), Associate professor**National Academy of the Security Service of Ukraine**Kyiv, Ukraine**orcid.org/0000-0003-3804-2356***Olena Kobus***Candidate in physics-mathematical science, Senior lecturer**Educational and Scientific Institute Of Information Security of National Academy of the Security Service of Ukraine**Kyiv, Ukraine**orcid.org/0000-0003-3130-6515***Petro Zaiets***Senior lecturer**Educational and Scientific Institute Of Information Security of National Academy of the Security Service of Ukraine**Kyiv, Ukraine*

GENRE DIVERSITY OF K-POP CULTURE AND ITS IMPACT ON THE MODERN WORLD (BASED ON K-POP CLIPPING)

Abstract. *Mass culture as a special sociocultural phenomenon allowed distinguishing the following characteristics as focus on the average person. "Clip culture" is a part of mass culture. Clipping is a type of aesthetic activity that is mass and democratic. It addresses to a multi-million television audience, which not only reflects but also influences the formation of mentalities, ethical orientations, which shapes current trends in modern popular music, fashion, dance, behavior. In our research we tried to analyze the clips which are popular in the countries or mostly viewed in YouTube sine 1992 to 2020 boys and girls groups or singers and their collabs. We found out that in order to make a fascinating visual product the clipmakers try to find an unexpected solution and finally create "masterpieces" with complicated social issues, using symbolic meanings and computer graphics or designs. Nowadays k-pop influences the American and European culture and life of people all over the world.*

Introduction

Mass culture being in the process of developing and transformation acquires new features and forms of manifestation. Among the latest trends in the development of mass culture researchers highlight the wide expansion of visual forms and genres that are universally displacing by so called "book culture". Television and computers not only reduce interest in the book, but also create a new mode of perception: a visual image [1].

Analysis of mass culture as a special sociocultural phenomenon allowed to distinguish the following characteristics as focus on the average person, on emotional, irrational, collective unconsciousness; escapism; fast availability; accelerated oblivion; traditionalism and conservatism; cosmopolitanism, usage of the average linguistic semiotic norms; curiosity, flexibility, the ability to broadcast artifacts created by other cultures and transform them into objects of mass consumption. In modern cultural studies, as a rule, there are three main levels of mass culture: kitsch culture (low-grade, in some sense vulgar culture), mid-culture (culture of the "middle hand"), art-culture (mass culture of certain levels of artistic content and aesthetic expression) [1].

The mass audience's love for music culture has led to the emergence of a new screen form such as a music video. Three or four-minute "sound pictures" could be considered as images of such clips of the early 20th century which inventor was German A. Messter. It was Hollywood cinemas with magnificent entertainment shows and live music concerts designed specifically for television of that time. However it would be difficult to make a music video clip as a special form of screen production without the development of show business, without the promotion of musical material to the masses with the help of visual packaging, without the active distribution of television broadcasting [9].

1. K-pop in mass culture

Screen clip culture appeared with small forms, providing complete information with snippets, as well as aggressive use of clips in the visual series. An on-screen video culture has emerged with its features, functional diversity and a certain dependence on socio-economic factors, where everything must be balanced, reasoned and balanced. In this case, the clip presentation of the material gives the main thing which is the necessary social information [9]. Those definitions of mass culture are regarded as a positive phenomenon. Ideas of mass culture, as the ability to vulgarize "true" values, are here opposed to the ideas of democratization of culture, which makes high spiritual values accessible to most of humanity. [9].

Today we can say that we live in a "clip culture". The appearance of the information society E. Toffler considered the consequence of the development of the media, and primarily electronic media with their multi-million mass audience [9].

Clipping is a type of aesthetic activity that is mass and democratic, addressed to a multi-million television audience, which not only reflects but also influences the formation of mentalities, ethical orientations, which shapes current trends in modern popular music, fashion, dance, behavior. Clipping in modern mass culture acts as an instrument of aesthetic communication of the masses, as an indicator of mental dynamics, through which the specific features of existential grounds and the ideological diversity of modern civilization of the masses are reflected [3]. Since the clip is a product designed primarily for teenage and youth audiences, it reflects all the subcultural diversity of this part of the mass culture, providing a stylish clipping diversity. Clipping quite clearly distinguishes the following style trends: gothic or post-punk, hip-hop, dance (rave) [3].

The word is derived from the English word "clip", which has a number of meanings, including "cut", "break" and "attach". This term has defined quite precisely the essence of the new phenomenon. The clip is a colorful collection of "scraps" of the modern world, arbitrarily formed into a certain image that obeys only the will of the author and unfolds to the music, introducing into it additional and often unexpected aspects of perception. Due to the genesis of the creative method, the clip is based on painting in the collage technique that emerged between the XIX and XX centuries. Collage (from Latin. Collectanea – collections of notes, a mixture) was formed in the modern era, that is why we can speak about the Gothic influence which is reflected in the revival of the stained glass art. The stained glass window in the modernist style was formed into a coherent image, but in the collage this integrity is broken, and the remaining pieces are folded into a random and meaningless picture. Even before the clip appeared, the collage reflected fragmentation, chaos, and fragility of being in the era of the world wars. However, the clip also has a significant difference from the collage due to the different species belonging to these genres. Collage is a spatial visual art and like painting is perceived simultaneously and in general. The clip as an artistic phenomenon gravitates to the temporal arts and, therefore, reveals its artistic image in time [3]. "A visual collage created in a special manner, with a fast frame shifting, where individual fragments of

the image were connected comparing to the whole, where the main thing was not to understand and feel the emotionally offered information from the screen so it became the norm for creating commercials. This led to the appearance of a fragmentary, clip-style installation. In addition, by cutting off the superfluous and leaving the so-called main thing, the creators of advertising reduced the overall duration of a particular screen work, saving advertisers money to pay for airtime. Gradually, the clip presentation of the material, or more simply – the cutting of frames, became an indispensable attribute of the commercials, the very shape of the screen was called a clip" [10].

If by outlook and creative method the clip is related to the collage, then it is actualized by design. Design as a form of goods aesthetization, originated in the middle of the XIX century. At the beginning of the XXI century in the mass culture conditions it became a poly-functional phenomenon that affects not only production and life, forms of social behavior, but also artistic forms. Design in the mass culture of the XXI century is increasingly becoming a life-forming phenomenon, shaping the aesthetic, ergonomic, so called utilitarian characteristics of the world of goods and services. The example of social design branding is MTV.

More than twenty years ago, the media (television) with the help of music and design created its brand, visually decorated in a graphic emblem "MTV". During its existence, the MTV brand has formed not only a global network of music TV channels, but also developed a style of behavior, a vocabulary directed in the youth fashion. It has its own classics, history and legends which is claimed into a specific lifestyle and mental habits. MTV was the main media channel for broadcasting clips until recently. Nowadays the Internet has taken the lead such channel as YouTube. Design performs the function of aesthetization the clip virtual space by means of web-design and design of clothes, accessories and interior and so on. The content of the clip is not limited to having a component design and contains such artistic elements as music, acting and directing. Such Clipmakers as Michel Gondry, Spike Jonze, and Chris Cunningham, Anton Corbijn, are widely known and can be seen in the context of contemporary cultural achievements [12; 13].

As an object of art design the clip, distinguishes artistic enigmatic. It is usually not logical, but associative and appeals to the subconsciousness, forcing archetypes, patterns and stereotypes of personality to work. The clip is characterized by the principle of additionality. Clip and music can have completely different content, but together they can sometimes be bizarre and quite interesting from an outlook and from an artistic point of view on the art object, combining elements of artistic image, technological characteristics and marketing features. [3]

Clipping is a global phenomenon of aesthetization of simulacra, the characteristic features of which are discretion of narrativity, enigmatic associativity, hyperbolization of the sign. The field of clipping is a virtual game with signs that indicate fragments of reality and artistic realities, during which the subject is its passive observer. In this context, the clip will act as a single clipping object that combines the main characteristics with the single specific features inherent in the clip as a product of art design. Clipping performs an important sociocultural function in the contemporary mass culture. The function of "starring" means the developing of the type of so called "culture hero", an adequate hyper reality. In the context of MTV, this is considered to be a "style icon". [4].

K-pop is translated as "Korean pop". It has been trying to break into the k-pop world stage for a long time, but it became possible not so long time ago. Among the reasons is a social network, Korean miracle cosmetics, Korean girls and boys' plastic surgery, and the lack of something new and 'fresh'. At the present stage of technological and technical progress Korean artists create their official accounts on such resources as Twitter, Insragram, Facebook and others. So it is possible for

you to get to know the big pop audience, to become a member of it, to join to this “k-pop live and activity” and these all helps to promote the genre more actively.

K-pop in mass culture also thrives as it includes the appearance of blue lipsticks and glitter in beauty corners, colored hair on the streets of cities and so on. Subculture quickly wins the hearts of even those who have no clue about it: now dyeing hair in pink, blue, purple is absolutely normal, even for a wealthy lady with the children. Light green, yellow or combination of pink and black (especially for men) in clothing, sparkles on the eyes, false eyelashes, bright eyeliner, daring jewelry all these are the influence of the Korean subculture [6].

K-pop is something quite unusual and extraordinary, even for all Americans and Europeans who are familiar with it. It was born in the 1980s in South Korea. K-pop features an almost limitless range for inspiration involving popular genres such as pop, rock, jazz, hip-hop, rap, reggae and others. The basis of k-pop music is the union of two or more genres together with vivid visual effects, fashion images and dance performances [8]. The melodies of Korean artists are so catchy that it doesn't matter that the song is in Korean and you hear it for the first time. Also important things are the standards of beauty among Asian people, which include the artists, well-rehearsed dances and vivid and colorful visual effects [6]. Nowadays Singers have to use English if they want to occupy markets in the other parts of Asia, which helps them to open the Western market. Of course, many K-pop singers learn English because it is a widespread language in the world of music. After the 1997 financial crisis, the government stopped censoring English lyrics and Korea started to have a boom in English. Since the late 1990s, English usage in singers' names, song titles, and lyrics has grown quickly. Seventeen singers in the top fifty charts used English names in 2000, and thirty-one did so in 2005. In 2010, forty-one singers used [5] .

From a little-known regional genre, k-pop became a worldwide hysteria in a few years. The multinational armies of fans go crazy around the world, calling their favorite and lovable artists "Idol" (from the English idol). Now it is clear that k-pop shapes European and American culture. From the very beginning, k-pop was formed based on Western sounds, including pop music, but later it developed into its own unique culture. It combines the rhythms and textures that define the song with a chaotic energy.

The products of the k-pop industry are much more tightly controlled than the music business in any other country. The music industry in South Korea has been subsidized by the government for over 15 years. The international popularity of k-pop is closely linked to the government's deliberate efforts to increase global exports of Korean goods, merch, outfits and so on. For example, many k-pop groups record Korean and Japanese (rarely English) versions of the same song, indicating their willingness to adapt to other cultures to expand their popularity. With the proliferation of the Internet and its resources, k-pop has come up with another way to reach Western audiences. The second wave of popularity began around 2005, almost entirely due to the band TVXQ, which released 12 albums over six years. Meanwhile, singer BoA became the first Korean star to break into the Japanese scene after a long cultural barrier that has existed since World War II [8]. The artist Psy became a worldwide phenomenon in 2012 with his viral hit on YouTube, Gangnam Style, which received 3 511 277 153 views and helped revive international interest in k-pop. Formed in 2013, the BTS boy band has won a dedicated fan base in Japan, Europe, the United States, receiving Billboard awards in 2017. And to date, they have gained a foothold in the Arab countries, that is, sweeping the world. BTS entered the world music history, becoming the first Korean, that is, Asian artists to perform at the stadium in New York. The 2018 BTS American Concerts became the highest selling in the US. The band's latest album, Love Yourself: Tear, reached the pinnacle of

American charts. BTS is the first Korean artist to be featured on the cover of TIME as the New Generation Leader, as well as the Top 25 Most Influential Internet Magazine (2018). This is a worthy reflection of the rapid rise in popularity of K-pop worldwide [8]. In 2020 the BTS boy band won in the nomination “the best group” in “Nickelodeon kids choice award 2020”.

Another significant factor that helps the growth of popularity is the formation of a dedicated fan base. Popular bands BTS, EXO, GOT7, SHINee have powerful "fandoms" that allow you to sell tickets to their shows within hours. The groups consistently have numbers of tours and fanmeetings. Adaptation the k-pop culture to the Western style without losing its Asian so called “special thrill” attracts new fans all over the world. Most of this audience and the most profitable consumer groups are teenagers. It's not to say that the older age groups don't listen to k-pop, because they do, but the large base of young fans has contributed to many victories in music nominations and the spread of Korean music around the world.

Integrated efforts to promote Korean pop culture, through television and music products, support from the government of creative industries, and collaboration with the brands well-known all the world, have contributed to the international spread of k-pop.

South Korea's pop culture is one of the driving forces of youth culture in the Asia-Pacific region today, with a particular focus on China, Hong Kong, Japan, Taiwan and much of Southeast Asia. However, more and more American artists are agreeing to work with Korean artists such as Missy Elliot, Kanye West, Jonas Brothers, DJ Steve Aoki, Marshmello, and Diplo, and many other hip-hop artists. In addition, Korean pop music has been praised by such well-known music producers as Quincy Jones, Teddy Riley, and Grammy-winning producer Alisha Kees. BIGBANG, EXO, BTS, solo artists PSY, G-Dragon (leader of BIGBANG) and CL brought the most popular k-pop internationally [14]. It is Well-known that BLACKPINK x LADY GAGA Collaboration Song will Be Released on May 29 titled “Sour Candy” [2] .

K-pop is often viewed negatively in terms of unnecessary sexualisation of artists for the sake of engaging audiences. It can be seen in the appearance of the artists, their outfits and choreography, focusing more on this than on creativity. The plastic operations are often used to create even more "ideal" idols, but with the development of the k-pop industry, many agencies favor the "natural" appearance of an artist by imposing a ban on plastic surgery in a contract. Many agencies and groups focus not so much on sexuality, but on "cute" behavior. The main point in criticism of k-pop is the obsession of some fans, as well as their unacceptable behavior and tendency to invade musicians' personal lives. To name such fans, the term "Sasen" is used in Korea, mainly referring to young girls who are fanatical about their idols.

The peculiarity of the k-pop industry, apart from albums (which are logically structured, sometimes within the years, such as Albums of BTS, Monsta X, etc.), tours (sometimes world-wide tours) is that they release 30-seconds trailers after launching a single or album in rotation. Some bands make a music movie after the release of the album, interweaving the clips and telling the whole story or stories, such as BTS Full Story: HYYH, WINGS, Love Yourself, make movies “behind the scene of the clip” and so on. Also, to get fans interested, many bands use so called “Easter eggs” or hidden meanings in their videos or encrypt different messages or riddles, such as BTS, TXT. They make films about their daily routines during the tours, which attract the fans, who want to know everything about their lovable idols.

The appearance of the artists should be perfect: beautiful, well-groomed girls and boys, with perfect hairstyles sometimes with bright hair, impeccable facial features and makeup, slim and sporty. Stage imagery is always trendy, bright, with lots of accessories. This is catchy, but what

attracts the most is the sophistication of the choreographic performances. Dance or dance performance is an integral part of any music video and live performance. Much attention is paid to the creation of characters in the group, which teach the younger generation to respect the elder ones: leader, vocalists, "visual", rappers, dancers. So there can be found the most experienced and senior member, and the youngest member – Makne, who often receives recognition in love. In fact, each of the members is strong and unique in one of the spheres, but that does not mean that he or she will not be able to replace the other participant if required [7].

2. Genres or trends in k-pop clipping

At the present stage of the development of clipping, there are several genres or trends [9]. We are going to use the term “trend” in our further research. The differentiation is based on semantic, aesthetic and design characteristics: Mythological trend; Futuristic trend; Historic-cultural trend; Existential trend; Animation trend; Dance trend; Ecological trend

K-pop clips are characterized by a domineering of dance trend, which is the main component; though, because the clip-art component of the clips is not related to their plot side, so the clip related to the same trend can be performed in different artistic manners. The groups also release songs and dance practices. However, the dance clip may be shot in a realistic manner, and may include elements of animation; the existential trend can be delivered in an art-house style or in a hyper-realistic manner inherent in computer games. For example: TXT "Angel Or Devil" or "Crown" and others. Here are the typical trends that can domineer in the clip though being combined with each other. We tried to analyze the clips which are popular in the countries or mostly viewed in YouTube sine 1992 to 2020 boys and girls groups or singers and their collabs:

Mythological trend. The video clip is based on fragments of mythological stories, taken from different myths, different religious systems. The designed style of such clips is characterized by a tendency towards realism and hyper-realism. This trend is aesthetic. Its imagery seeks to the beauty and decoration without assuming moralistic summaries, ethical teachings. The goal of this trend is to give the compositions and the musicians themselves an epic and embeddedness in a metacultural context.

Table 1.

Year	Boys Group Clips	Singer or Collab
2009	TVXQ! 동방신기 '주문 - MIROTIC' (combined with dance trend); TVXQ! 동방신기 'Rising Sun (순수)' (combined with dance trend); SHINee 샤이니 'Ring Ding Dong' (combined with dance trend); TVXQ! 동방신기 'Tri-Angle (Extended Ver.) (Feat. BoA & TRAX)';	
2012	EXO-K 엑소케이 'MAMA' (combined with dance and ecological trend);	
2013	빅스(VIXX) - 저주인형 (Voodoo Doll)	
2016	BTS (방탄소년단) '피 땀 눈물 (Blood Sweat & Tears)' (combined with futuristic, historic-cultural and dance trends);	
2017	SF9 (에스에프나인) _ O Sole Mio(오솔레미오) (combined with futuristic and dance trends); N.Flying(엔플라잉) _ The Real(진짜가 나타났다);	TAEMIN 테민 'Flame of Love' (combined with futuristic and dance trends);
2020	Jackson Wang - 100 Ways (combined with dance and historic cultural trends); NOIR(느와르) - "Lucifer" (combined with dance trend);	

Girls Group Clips and girls' Singles or Collabs wasn't found, but we hope in future they will appear.

Futuristic trend. It consists of two fundamental features of civilization: the machine world and space fiction. A certain proportion of magical perception, fairytale is also present here including the machines with human traits and different magical properties. Often, the production of such clips uses experimental advances in computer technology.

Table 2.

Year	Boys Group Clips	Singer or Collab	Girls Group Clips	Singer or Collab
2010	BEAST - 'SHOCK' (combined with dance trend);			
2011				Lee Hyo Ri(이효리) - ChittyChitty BangBang (combined with existential and dance trends); IU(아이유) - You&I (너랑나) (combined with animalistic and dance trend);
2012	빅스(VIXX) - Rock Ur Body 뮤직비디오 [VIXX] Rock Ur Body (combined with dance trend); SHINee 샤이니 'Sherlock•셜록 (Clue + Note)' (combined with dance trend); SHINee - 「1000回、ずっとそばにいて□□□」 (combined with existential trend); SUPER JUNIOR 슈퍼주니어 'Sexy, Free & Single' (combined with dance trend); BIGBANG - FANTASTIC BABY (combined with existential trend);		Girls' Generation 'Time Machine' (combined with animalistic trend); T-ARA(티아라) - Sexy Love (combined with dance trend);	
2013	빅스 (VIXX) - 다칠 준비가 돼 있어 (On and On) (combined with dance trend); SHINee 샤이니			

	'Dream Girl' (combined with dance trend) ; SHINee 샤이니 'Dream Girl' (combined with dance trend) ;			
2014	빅스(VIXX) - Error Official Music Video; BOYFRIEND(보이프렌드) - WITCH (combined with dance trend) ; GD X TAEYANG - GOOD BOY (combined with dance trend) ;		Girls' Generation 소녀시대 'Mr.Mr.' (combined with dance trend) ; 2NE1 - COME BACK HOME	
2015	BIGBANG 뱅뱅뱅 (BANG BANG BANG); SHINee - 「D×D×D」 (combined with dance trend) ; BOYFRIEND(보이프렌드) - BOUNCE (combined with dance trend) ; SHINee 샤이니 'Married To The Music' (combined with dance trend) ; BIGBANG - BAE BAE (combined with ecological and existential trends) ;		TWICE "Like OOH-AHH(OOH-AHH하게) (combined with dance trend) ;	
2016	EXO 엑소 'Lucky One' ;	지코 (ZICO) - Bermuda Triangle (Feat. Crush, DEAN) (combined with ecological trend) ; [STATION] 유재석 X EXO 'Dancing King' (combined with historic cultural and dance trends) ; Agust D 'Agust D' (combined with existential trend) ;	TWICE "TT" (combined with dance trend) ; BLACKPINK - '휘파람'(WHISTLE) (combined with ecological and dance trends) ;	
2017	EXO 엑소 'Ko Ko Bop' (combined with ecological and dance trends) ; EXO 엑소 'Power'; 몬스타엑스(MONSTA X) - DRAMARAMA (combined with existential and dance trends) ;	Loco (로꼬) Too Much (지나쳐) (Feat. DEAN)	TWICE "SIGNAL" (combined with dance trend) ; GFRIEND(여자친구) - FINGERTIP (combined with	

	BTS (방탄소년단) 'DNA' (combined with existential and dance trends);		dance trend);	
2018	BTS (방탄소년단) 'FAKE LOVE' (combined with existential and dance trends);	Hcue - I Feel So Lucky (Official Video) ft. A.C.E (combined with dance trend); Loco (로꼬), GRAY - Late Night (combined with historic-cultural trend); j-hope 'Daydream (백일몽)' (combined with historic-cultural and dance trends); RM 'moonchild';	BLACKPINK - '뚜두뚜두 (DDU-DU DDU-DU)' (combined with existential and dance trends)	
2019	A.C.E (에이스) - 삐딱선 (Savage) (combined with dance trend); A.C.E(에이스) - Under Cover (combined with dance and ecological trends); CIX (씨아이엑스) - Movie Star (combined with dance trend); CIX - My New World (combined with dance trend); SuperM 슈퍼엠 'Jopping' (combined with dance trend); EXO 엑소 'Obsession' (combined with dance trend); ATEEZ(에이티즈) - 'WONDERLAND' (combined with historic-cultural, dance and ecological trends); WayV 威神V '天选之城 (Moonwalk)' (combined with dance trend); WayV 威神V '理所当然 (Regular)' (combined with dance trend); NCT 127 엔시티	Loco(로꼬) - It's been a while(오랜만이야) (Feat. Zion.T) (combined with historic-cultural trend);		[MV] IU(아이유) - above the time(시간의 바깥) (combined with historic-cultural, dance and ecological trends);

	<p>127 'Superhuman' (combined with dance trend); NCT DREAM 엔시티 드림 'BOOM' (combined with dance and historic-cultural trends); PENTAGON(펜타곤) _ SHA LA LA(신토불이); THE BOYZ(더보이즈) _ D.D.D (combined with dance trend); 온앤오프 (ONF)_Why (combined with dance and existential trends); TXT (투모로우바이투게더) '어느날 머리에서 뿔이 자랐다 (CROWN)' (combined with dance and existential trends); TXT (투모로우바이투게더) 'Angel Or Devil' (combined with dance and existential trends); CIX (씨아이엑스) - Movie Star (combined with dance trend);</p>			
2020	<p>Monsta X - YOU CAN'T HOLD MY HEART; ASTRO 아스트로 - Knock(널 찾아가) (combined with dance trend);</p>	<p>MUSM _ Be My Guest (Feat. NONE) (Prod. 7anhee(탄희), Sonak Moon(문소낙))</p>		

Historic-cultural trend is multilayered in its structure, and the image in such clips is based on a combination of artifacts of different eras and cultures. Video clips of this direction are created from different forms of visual realities: for example, a concert life of a performer, on the basis of which a clip is shot, where the artist's life is transmitted in the form of his/her previous clips, fragments of documentary, art history in the form of fragments from old silent movies. Within the historic-cultural trend an **ethnic trend** can be distinguished and, of course, cultural trend in esthetic sense itself. The ethnic trend uses the scenes of life and artifacts, ethnic culture which can be exotic to mass culture.

Table 3.

Year	Boys Group Clips	Singer or Collab	Girls Group Clips	Singer or Collab
2008			Wonder Girls "So Hot" (combined with dance and existential trends);	
2010			Girls' Generation 소녀시대 'Oh!'	

			(combined with dance trend); Girls' Generation 소녀시대 '훗 (Hoot)' (combined with dance trend);	
2011	2PM "HANDS UP			Lee Hyo Ri (이효리) - U-Go-Girl (유고걸) (With. 낫선) (combined with dance trend); IU (아이유) _ Good Day (좋은 날) (combined with ecological and dance trends); BoA 보아 'Eat You Up' MV Cha Ver.
2012	SUPER JUNIOR 슈퍼주니어 'SPY' (combined with dance trend);	PSY - Gangnam Style(강남스타일) (combined with dance trend)	Girls' Generation 少女時代 'PAPARAZZI'	
2013	B.A.P – Hurricane; BTS (방탄소년단) 'No More Dream' Official (combined with existential and dance trends);	PSY – Gentleman (combined with dance trend); T.O.P - DOOM DADA		이효리 (Lee Hyori) - 미스코리아 (Miss Korea) (combined with dance trend); 이효리 (Lee Hyori) - 미쳐 (Going Crazy); IU(아이유) – Friday(금요일에 만나요) (Feat. Jang Yi-jeong(장이정) of HISTORY(히스토리)); IU(아이유) _ The red shoes(분홍신) (combined with dance trend);
2014	SUPER JUNIOR 슈퍼주니어 'MAMACITA (아야야)' (combined with dance trend); GOT7 "Girls Girls Girls" (combined with dance trend);			

2015	EXO 엑소 'LOVE ME RIGHT' (combined with dance and ecological trends); 몬스타엑스 (MONSTA X) - 신속히 (RUSH) (combined with dance trend); SHINee 샤이니 'View' (combined with dance trend); BIGBANG - WE LIKE 2 PARTY;	PSY - Daddy(feat. CL of 2NE1) (combined with dance trend);	Girls' Generation 소녀시대 'Lion Heart'; T-ARA[티아라] "완전 미쳤네 [So Crazy]" (combined with dance and existential trends);	
2016			TWICE "CHEER UP" (combined with dance trend); AOA(에이오에이) - Good Luck(굿럭) (combined with dance trend);	헤이즈 (Heize) - And July (Feat. DEAN, DJ Friz); 헤이즈 (Heize) - Shut Up & Groove (Feat. DEAN);
2017	BTOB(비투비) _ MOVIE (combined with dance trend); Wanna One (워너원) - 에너제틱 (Energetic) (combined with dance trend);	라비 (RAVI) - BOMB (Feat. San E) (combined with dance trend); PSY - 'New Face' (combined with dance trend);	마마무(MAMAMOO) - '나로 말할 것 같으면(Yes I am)' (combined with dance and existential trends); TWICE "LIKEY" (combined with dance trend); AOA _ Excuse Me (combined with dance and existential trends);	IU(아이유) _ Bbibbi(뽀뽀) (combined with dance trend); SURAN(수란) _ 1+1=0 (Feat. DEAN); SUNMI(선미) _ Gashina(가시나) (combined with floristic trend);
2018	EXO 엑소 'Tempo' (combined with futuristic and dance trends); Stray Kids "My Pace" (combined with dance trend); NCT 127 엔시티 127 'Regular (English Ver.)' (combined with dance and animalistic trend); NCT 127 엔시티 127 'Simon Says' (combined with dance, futuristic and existential trends); NCT DREAM	지코 (ZICO) - Tough Cookie (Feat. Don Mills) (combined with dance trend); 지코 (ZICO) - SoulMate (Feat. 아이유); Loco(로꼬) _ Party Band (Feat. PUNCHNELLO, Thur) + OPPA (combined with futuristic trend); j-hope 'Airplane'	MOMOLAND(모모랜드) _ BAAM (combined with dance and futuristic trends); MOMOLAND (모모랜드) _ BBoom BBoom (뽐뽐) (combined with dance and futuristic trends);	IU(아이유) _ Ending Scene(이런 엔딩) (combined with futuristic trend); JENNIE - 'SOLO' (combined with ecological and dance trends);

	<p>엔시티 드림 'GO' (combined with dance trend); [STATION X 0] 찬열 (CHANYEOL) X 세훈 (SEHUN) 'We Young'; iKON - '사랑을 했다(LOVE SCENARIO)' (combined with dance trend); SF9 (에스에프나인) - MAMMA MIA (combined with dance trend); BTS (防彈少年團) 'Airplane pt.2 -Japanese ver.-'; N.Flying (엔플라잉) - Hot Potato (뜨거운 감자) (combined with existential trend);</p>	<p>(combined with existential trend); RM JHOPE SUGA — 땡; RM 'seoul (prod. HONNE)'</p>		
2019	<p>MONSTA X - 「X-Phenomenon」 (combined with dance and futuristic trends); Stray Kids "Double Knot" (combined with dance trend); [MIXTAPE] 민혁 (MINHYUK) - 응심이 (feat. JOOHONEY); WayV 威神V '无翼而飞 (Take Off)' (combined with dance trend); EXO-SC 세훈&찬열 'What a life'; SUPER JUNIOR 슈퍼주니어</p>	<p>Jackson Wang - DWAY!; Jason Derulo, LAY, NCT 127 - Let's Shut Up & Dance (combined with dance trend); Monsta X - WHO DO U LOVE? ft. French Montana (combined with dance trend); TAEMIN 'Famous' (combined with dance trend); BTS (방탄소년단) '작은 것들을 위한 시 (Boy With Luv) (feat. Halsey)' (combined with dance trend);</p>	<p>마마무(MAMAMOO) - HIP (combined with dance and existential trends);</p>	<p>IU(아이유) - Blueming (블루밍)</p>

	'SUPER Clap' (combined with dance trend); ONEUS(원어스) - Twilight(태양이 떨어진다) (combined with dance trend);	BTS (방탄소년단) 'IDOL (Feat. Nicki Minaj)' (combined with dance and futuristic trends);		
2020	NCT 127 엔시티 127 '영웅 (英雄; Kick It)' (combined with dance trend); BTS (방탄소년단) 'ON' (combined with existential trend);	Raiden X 찬열 CHANYEOL 'Yours (Feat. 이하이, 창모)'	ITZY "WANNABE" (combined with dance trend);	핫펠트 (HA:TFELT) - Cigar ;

Existential trend is the direction of clipping that raises the question of the values of human existence. This kind of clip is typical to musical groups, which creative aspirations have a pronounced social orientation. The clips of this trend can include footage of a documentary chronicle. It can also reproduce "quotes" from the video series of cinematographic works, thus using them as samples.

Table 4.

Year	Boys Group Clips	Singer or Collab	Girls Group Clips	Singer or Collab
2009	BIGBANG - 하루하루(HARU HARU) (combined with dance trend);			
2011	BEAST - 'FICTION'(combined with dance and historic-cultural trends); SS501 - Love Like This (combined with dance trend); SHINee 샤이니 '누난 너무 예뻐 (Replay)' (combined with dance trend);	BANG YONG GUK (방용국) - I Remember (with YANG YO SEOP);	T-ARA(티아라) _ Roly-Poly in Copacabana (combined with dance trend); 2NE1 - 내가 제일 잘 나가(I AM THE BEST) (combined with dance trend);	Song Ji-Eun(송지은 of Secret)_ Going Crazy(미친거니)(Feat. Bang Yong-Gook);
2012	B.A.P - 하지마 (STOP IT) (combined with futuristic trend); 달마시안 (DALMATIAN) - E.R (combined with dance		4MINUTE - 'Volume Up' (combined with dance, futuristic and ecological trend); 2NE1 - I LOVE YOU;	BoA 보아 'The Shadow' (combined with dance trend); Ailee(에일리) _ I will show you(보여줄게)

	<p>trend); BTOB - 비밀(Insane) (combined with dance trend); BTOB - 그 입술을 뺏았어(Irresistible Lips) (combined with dance trend); BTOB - 'WOW' (combined with dance trend); Block B(블락비) - NalinA(난리나); NU'EST(뉴이스트) - Action; TEEN TOP(틴탑)_Rocking(장난아냐) (combined with dance trend); 보이프렌드(BOYFRIEND) - 야누스(JANUS) (combined with dance trend); BIGBANG - MONSTER;</p>			(combined with dance trend);
2013	<p>B.A.P - ONE SHOT; B.A.P - Badman (combined with dance trend); B.A.P - 빗소리(Rain Sound); BTS (방탄소년단) 'N.O' (combined with dance and futuristic trends);</p>	<p>케이윌(K.will) - 촌스럽게 왜 이래 (You don't know love);</p>	<p>T-ARA(티아라) - Lie(거짓말) (Part.1) (combined with dance trend);</p>	
2014	<p>B.A.P - 1004(Angel) (combined with animalistic trend); 빅스(VIXX) - 기적(ETERNITY) (combined with dance trend); BTS(방탄소년단) - Boy In Luv(상남자) (combined with dance trend); BTS(방탄소년단) - War of Hormone(호르몬 전쟁) (combined with dance trend); BEAST - 'GOOD LUCK' (combined with dance trend); INFINITE "Back"; BTS(방탄소년단) - Danger (combined with dance trend);</p>			<p>SONGJIEUN(송지은) - Don't Look At Me Like That(쳐다보지마);</p>

<p>2015</p>	<p>MONSTA X(몬스타엑스) _ Trespass(무단침입) (combined with dance trend); 2PM "My House(우리집)" (combined with dance trend); MADTOWN (매드타운) _ OMGT (combined with dance trend); BTS(방탄소년단) _ Run (combined with dance trend); BTS (방탄소년단) 'FOR YOU' (combined with dance trend); BTS(방탄소년단) _ I NEED U; BIGBANG – LOSER;</p>	<p>Rap Monster 'Do You'; Rap Monster '농담'</p>	<p>Girls' Generation 소녀시대 'You Think' (combined with dance and ecological trend trends); 마마무 (MAMAMOO) - 음오아예 (Um Oh Ah Yeh) (combined with dance and historic-cultural trends);</p>	
<p>2016</p>	<p>EXO 엑소 'Lotto' (combined with dance trend); 몬스타엑스 (MONSTA X) _ Fighter (combined with futuristic and ecological trend); 몬스타엑스 (MONSTA X) _ 걸어 (ALL IN); SHINee 샤이니 'Tell Me What To Do' (combined with futuristic trend); NCT 127 엔시티 127 '소방차 (Fire Truck)' (combined with dance trend); EXO-CBX (첸백시) 'Hey Mama!' (combined with dance and historic cultural trends); 크나큰(KNK) – KNOCK (combined with dance trend); 크나큰(KNK) - BACK AGAIN (combined with dance and floristic trend); BTOB(비투비) - 기도(I'll be your man) (combined with dance trend); B1A4 _ BABY I'M SORRY (combined with dance trend); BTS (방탄소년단) '불타오르네'</p>	<p>TAEMIN 태민 'Press Your Number' (combined with dance and ecological trend);</p>	<p>[MAMAMOO] 1CM의 자존심; Wonder Girls "Why So Lonely"; Red Velvet 레드벨벳 '피카부 (Peek-A-Boo)' (combined with dance and ecological trend); 4MINUTE(포미닛) - 싫어(Hate) (combined with dance trend); 여자친구(GFRIEND) _ 시간을 달려서(Rough) (combined with dance and ecological trend);</p>	

	(FIRE)' (combined with dance trend); BTS (방탄소년단) 'EPILOGUE : Young Forever' (combined with dance trend); Agust D 'give it to me'; BIGBANG - '에라 모르겠다(FXXK IT)' 블락비 (Block B) - Toy (combined with dance trend);			
2017	B.A.P _ Wake Me Up; 크나큰 (KNK) - 비 (Rain) (combined with dance and ecological trend); 크나큰 (KNK) - 해, 달, 별 (Sun, Moon, Star) (combined with dance trend); BTS (방탄소년단) - Come Back Home; SUPER JUNIOR 슈퍼주니어 'Black Suit' (combined with dance and historic cultural trends); BTS (방탄소년단) 'Not Today' (combined with dance and futuristic trends);	RM, Wale 'Change' (combined with futuristic and historic cultural trends);		
2018	Trouble Maker(트러블메이커) _ Now(내일은 없어); EXO 엑소 'Love Shot' (combined with dance trend); NCT 127 'Chain' (combined with dance trend); TAEMIN 태민 > 'Under My Skin'; EXO-CBX 'Horololo' (combined with dance and historic cultural trends); EXO-CBX (첸백시) '□요일 (Blooming Day)' (combined with dance trend); SUPER JUNIOR 슈퍼주니어 'Lo Siento (Feat. Leslie Grace)' (combined with dance and ecological trend); The Rose (더 로즈) - BABY; WINNER - 'EVERYDAY'	Steve Aoki - Waste It On Me feat. BTS (combined with historic cultural trend);	Red Velvet 레드벨벳 'Bad Boy' (combined with dance trend); BLACKPINK - '붐바야'(BOOMBAYAH) (combined with dance trend); GFRIEND(여자친구) _ Time for the moon night(밤) (combined with floristic trend);	

	<p>(combined with dance trend); PENTAGON(펜타곤) - Shine(빛나리) (combined with dance trend); PENTAGON(펜타곤) - Naughty boy(청개구리) (combined with dance trend);</p>			
2019	<p>Monsta X - MIDDLE OF THE NIGHT; Stray Kids "MIROH" (combined with dance trend); Stray Kids "부작용(Side Effects)" (combined with futuristic and dance trends); Stray Kids "승전가(Victory Song)" Performance Video (combined with dance trend); MONSTA X 몬스타엑스 'FIND YOU'; WayV ㅁㅁV 'Love Talk'; 김우성 (WooSung) - FACE; WINNER - 'SOSO'; BTS 'Lights' (combined with dance and historic-cultural trend);</p>	<p>BAEKHYUN 백현 'UN Village'</p>	<p>마마무(MAMAMOO) - 고고베베(gogobebe) (combined with dance and futuristic trend); MOMOLAND(모모랜드) - I'm So Hot (combined with dance trend); Red Velvet 레드벨벳 'Psycho' (combined with dance, historic-cultural and ecological trends);</p>	<p>화사(HWASA) - 멍청이(TWIT) (combined with dance and ecological trend);</p>
2020	<p>Millenasia Project 'Be The Future' (feat. Dreamcatcher, Alexa & IN2IT) (combined with animation trends); NU'EST - I'm in Trouble (combined with dance and ecological trends); DAY6 "Zombie";</p>		<p>GFRIEND (여자친구) '교차로 (Crossroads)' (combined with futuristic and ecological trends);</p>	<p>Stella Jang(스텔라장) - Villain(빌런); BIBI(비비) - KAZINO(사장님 도박은 재미로 하셔야 합니다);</p>

Animation trend is a trend that uses a cartoon form, and the characters can be not only fictional, but also real persons or person (for example the artists themselves), who sing this song.

Table 5.

Year	Boys Group Clips	Singer or Collab	Girls Group Clips	Singer or Collab
2013				이효리 (Lee Hyori) - Bad Girls (배드 걸스) (in the form of comics combined with historic-cultural trend);
2017	NCT 127 엔시티 127 'Cherry Bomb' (combined with dance trend); EXO-CBX /「Ka-CHING!」 MUSIC VIDEO -Short Ver.- (in the form of comics combined with dance and futuristic trends);			
2018	[STATION] SUPER JUNIOR 슈퍼주니어 'Super Duper' ;	RM 'forever rain'	AOA _ Bingle Bangle(빙글빙글) ((in the form of computer games combined with dance and futuristic trends);	
2019	BTS (방탄소년단) 'Make It Right (feat. Lauv)' (combined with historic-cultural trend);			
2020				[MV] IU(아이유) _ eight(에잇) (Prod.&Feat. SUGA of BTS) (combined with historic-cultural and animalistic trends); YOUNHA(윤하) _ WINTER FLOWER(雪中梅) (Feat.RM);

Dance trend is a trend that has become especially popular since 2000. It is characterized by the almost complete absence of plot logic. Its content is the dance accompaniment of musical recordings. As a rule, dance clips are very sensual and erotic in their imagery. Sometimes it can be on the verge of conventional ethical ideas.

Table 6.

Year	Boys Group Clips	Singer or Collab	Girls Group Clips	Singer or Collab
1992	Seo Taiji “Nan arayo” or Taijiboys “I know, 서태지와 아이들 - 난 알아요”			
1996	H.O.T. “We Are The Future”; “Candy”			
1997			S.E.S “Im Your Girl”	
1999	H.O.T. - 아이야 (I Yah); 환희 (It's Been Raining Since You Left Me), 투지(Get It Up)f”			
2000	H.O.T - 아웃사이드 캐슬 (Outside castle)			BOA “Eat You Up”
2009	SUPER JUNIOR 슈퍼주니어 '쏘리 쏘리 (SORRY, SORRY);		Girls' Generation 소녀시대 'Gee'	BoA 보아 'Energetic'
2010	SUPER JUNIOR 슈퍼주니어 '미인아 (Bonamana)'		Girls' Generation 소녀시대 'Run Devil Run'; Girls' Generation 소녀시대 '소원을 말해봐 (Genie)' (combined with futuristic trend) ; miss A "Bad Girl, Good Girl" (combined with historic-cultural and existential trends) ;	
2011	U-KISS(유키스) Neverland(네버랜드); SUPER JUNIOR 슈퍼주니어 'Mr. Simple'; SS501 LOVEYA;		Girls' Generation 少女時代 'Bad Girl' ; T-ara(티아라) _ Cry Cry; f(x) 에프엑스 'Electric Shock'Wonder Girls "Be My Baby";	T-ara & Supernova (티아라 & 초신성) _ TTL (TIME TO LOVE) (combined with existential trend) ;
2012	B.A.P _ No Mercy; 빅스(VIXX) Super Hero 뮤직비디오([VIXX] Super Hero; U-KISS 'Believe';		Girls' Generation - 소녀시대 'I Got A Boy'; Girls' Generation 소녀시대 'Dancing Queen'; Girls` Generation 少女時代 _flower power; f(x) 에프엑스 'Hot Summer' (combined with existential trend) ;	

2013	EXO 엑소 '으르렁 (Growl)'; SHINee 샤이니 'Everybody'; SHINee - 「Breaking News」; BTS(방탄소년단)_ We Are Bulletproof Pt2(위 아 불렛프루프 Pt.2) (combined with historic-cultural trend);	Henry 헨리 'TRAP' MV (with Kyuhyun & Taemin) (combined with existential trend);	Girls' Generation 少女時代 'Galaxy Supernova' Mv Dance Ver.; T-ARA[티아라] "NUMBER NINE [넘버나인]"; SISTAR(씨스타) - Give It To Me (combined with historic-cultural trend); f(x) 에프엑스 '첫 사랑니 (Rum Pum Pum Pum)'; miss A "Hush";	
2014	B.A.P_Warrior, EXO-K 엑소케이 '중독(Overdose)' (combined with futuristic trend); 2PM "GO CRAZY!(미친거 아니야?)" BTS(방탄소년단) _ Just One Day(하루만) (combined with cultural and existential trends);	TAEMIN 태민 '괴도 (Danger)'		
2015	HISTORY(히스토리) _ Might Just Die(죽어버릴지도 몰라) (Performance ver.); EXO 엑소 'CALL ME BABY'; 몬스타엑스 (MONSTAX) - 히어로 (HERO) Rooftop Ver.; BTS(방탄소년단) _ DOPE(떨어) (combined with existential trend); UNIQ(유니크) _ EOEO (combined with futuristic trend); UP10TION(업텐션) _ So, Dangerous(위험해) (combined with existential trend);	BIGBANG(GD&T.O.P) - 떨어(ZUTTER);	Girls' Generation 소녀시대 'Catch Me If You Can' (combined with historic-cultural trend); 4MINUTE - 미쳐(Crazy)	AMBER 엠버 'SHAKE THAT BRASS (Feat. 태연 (소녀시대))' ' (combined with futuristic trend);
2016	빅스(VIXX) – Fantasy; EXO 엑소 'Monster' (combined with futuristic trend); 몬스타엑스(MONSTAX) _ 네게만 집착해(Stuck); SHINee 샤이니 '1 of 1'; BTS (방탄소년단) 'Save ME' (combined with ecological trend); HISTORY(히스토리) _ Queen (combined with existential and historic-cultural trends)		씨스타(SISTAR) _ I Like That (combined with ecological trend);	
2017	B.A.P _ Hands Up; 몬스타엑스(MONSTAX) -	TAEMIN 태민	BLACKPINK - '마지막처럼 (AS IF IT'S YOUR LAST)';	

	아름다워(Beautiful) (combined with existential and ecological trends); iKON - 'BLING BLING' (combined with futuristic trend); WINNER - 'REALLY REALLY'; BTS (방탄소년단) 'MIC Drop (Steve Aoki Remix)' (combined with existential trends); ASTRO 아스트로 - 니가 불러와(Crazy Sexy Cool) (combined with existential, futuristic and ecological trends);	'MOVE' (combined with futuristic trend);		
2018	Trouble Maker(트러블메이커) – Trouble Maker (combined with historic-cultural and ecological trends); 몬스타엑스(MONSTA X) – JEALOUSY (combined with mythological and existential trends); MONSTA X 「LIVIN' IT UP」 (combined with futuristic trend); MONSTA X - 「SPOTLIGHT」; ATEEZ (에이티즈) - 해적왕 (Pirate King); MONSTA X 몬스타엑스 'Shoot Out' (combined with existential trend); NCT 2018 엔시티 2018 'Black on Black'; NCT U 엔시티 유 'BOSS'; Wanna One (워너원) - 'BOOMERANG (부메랑)' (combined with futuristic trend);			
2019	CIX (씨아이엑스) - 순수의 시대 (Numb) (combined with existential trend); AB6IX (에이비식스) 'Breathe' M/V (Performance Ver.); AB6IX (에이비식스) 'Hollywood' Performance (combined with historic -cultural trend); MONSTA X 몬스타엑스 'FOLLOW' (combined with futuristic and ecological trends);	j-hope 'Chicken Noodle Soup (feat. Becky G)' (combined with historic -cultural trend);		

	ATEEZ(에이티즈) - 'HALA HALA (Hearts Awakened, Live Alive)'; WayV 威神V '无翼而飞 (Take Off)'; NCT 127 'Wakey-Wakey' (combined with futuristic trend); NOIR(느와르) "둠둠(Doom Doom)" (combined with ecological trend); 크나큰 (KNK) - SUNSET; ONEUS(원어스) - Valkyrie(발키리);		
2020	NCT DREAM 엔시티 드림 'Ridin'; BTS (방탄소년단) 'Black Swan' Official; BTS (방탄소년단) 'Black Swan' Art Film performed by MN Dance Company; BTS (방탄소년단) 'ON' Kinetic Manifesto Film : Come Prima;		EVERGLOW (에버글로우) - DUN DUN (combined with existential trend); 청하(CHU NG HA) - "Stay Tonight"; 솔라(SOLAR) - 뱀어(Spit it out);

Analyzing the latest trends in the k-pop industry, in our opinion, **ecological trend** should be included. Nature in general, i.e. flora, fauna and natural elements, attracts artists since the ancient times. Here we can distinguish **animalistic trend**. The association and use of animal images or comparisons with them is inherent in the Asian industry for depicting power, sexuality or something very sweet. Within the ecological trend the **floristic trend** should be mentioned.

Table 7.

Year	Boys Group Clips	Singer or Collab	Girls Group Clips
2009	東方神起 / Stay With Me Tonight;		
2011			Girls' Generation 소녀시대 'The Boys' (combined with dance trend);
2012	EXO-K 엑소케이 'History' (combined with dance trend);		
2013	빅스(VIXX) - [hyde]; EXO 엑소 '늑대와 미녀 (Wolf)' (domineering in concept) (combined with dance trend); SHINee - 「Boys Meet U」 (combined with historic-cultural trend);		
2015	빅스(VIXX) - 사슬 (Chained up)'		Girls' Generation 소녀시대 'PARTY';
2016		TAEMIN 테민 'sayonara hitori' (combined with dance and	

		futuristic trends ; TAEMIN 태민 'Drip Drop' Performance Video(combined with dance trend);	
2017	B.A.P _ HONEYMOON; A.C.E(에이스) - 선인장(CACTUS) (combined with dance and futuristic trends); 몬스타엑스(MONSTA X) - SHINE FOREVER (combined with dance, existential and futuristic trends);		
2018	SHINee 샤이니 '데리러 가 (Good Evening)' (combined with dance and futuristic trends); SUPER JUNIOR (슈퍼주니어) X REIK 'One More Time (Otra Vez)' (combined with dance and futuristic trends); UP10TION(업텐션) _ Blue Rose (combined with dance and existential trends); TXT (투모로우바이투게더) '9와 4분의 3 승강장에서 너를 기다려 (Run Away)' (combined with dance and futuristic trends); N.Flying(엔플라잉) _ HOW R U TODAY (combined with existential trend);		Girls' Generation-Oh!GG 소녀시대-Oh!GG '몰랐니 (Lil' Touch)' (combined with dance trend); 마마무(MAMAMOO) - 너나 해(Egotistic) (combined with dance trend); TWICE "Dance The Night Away" (combined with dance trend);
2019	MONSTA X 몬스타엑스 'Alligator' (combined with dance and futuristic trends); TAEMIN 태민 'WANT' (combined with dance and futuristic trends); TXT (투모로우바이투게더) 'Cat & Dog' (combined with dance and futuristic trends); ASTRO 아스트로 - Blue Flame (combined with dance and futuristic trends); ASTRO 아스트로 - All Night(전화해) (combined with dance trend);	LAY 'Honey (和你)' (combined with dance and futuristic trends);	BLACKPINK - 'Kill This Love' (combined with dance, existential and futuristic trends);
2020	BTS (방탄소년단) - Black Swan [Music Bank / 2020.02.28] (combined with dance trend); CIX – Revival (combined with dance and futuristic trends);		

Girls' Singles or Collabs wasn't found, but we hope in future they will appear.

In order to make a fascinating visual product the clipmakers try to find an unexpected solution. They look for the second meaning in the words of the selected track, illustrate the song frame by frame, create a resonance between the video sequence and the text, i.e. recreate in the clip what the person, who listen to this track, does not expect to see on. As for the coincidence of the boundaries of the foreshortening plans and musical motif-phrasal structures, two options can be noted here:

1) when the image was edited strictly for musical and vocal reasons;

2) To give the song video additional astringency, there is a second option when the video editing contradicts the structural and musical logic. In order to give the media piece more dynamics the logic can be periodically violated and its editing is contrary to the melodic line. An analogy with the alternation of a stable and unstable structure in classical music can be described as a violation of the above logic, an unstable structure.

Mostly the basis of most song video clips is the rhythmically quick editing of frames. Quick installation of frames can act as a kind of "video interruptions" (video breaks) between vocal phrases which visually emphasize the musical stanza texture (phraseological editing). In lyrical compositions clipmakers refuse from fast "clip" editing frames back-to-back. Here one can often see the smooth movement of the camera and the "influx" of images, carried out in parallel with musical phrases. The nature of the music also involves a certain method of shooting: camera angles, the distribution of light and color, the corresponding background and so on. These clips are shot in different public place: in the street, in a side street, in a store, in a shopping center, theme parks, etc., in abandoned factory, underground parkings, in the house (rooms, kitchen, etc.), walls, roofs and so on. At the beginning of the k-pop era there were concert videos, in 90's and 00's there were dance videos. But then the new tendencies with the influence of foreign (especially American) culture appeared. There appeared creative ideas using special video effects, sometimes even computer graphics, fantastic images and video editing, correlated with musical and speech structures.

In 2020 even clips with dance trend are shot with the usage of special effects, play of lights combining with existential meaning (*Table 6.*). Since 2013 there appeared a tendency of animation usage in the clips (*Table 5.*). The ecological trend became popular since 2013 (though appeared in 2009) and is used not only as a background, but also in a symbolic meaning (*Table 7.*). Mythological trend is not very popular, though some groups use it for their clips (*Table 1.*). In k-pop existential trend is closely combined with historic cultural trend due to specific peculiarities of Korean culture (*Table 4., Table 3.*). Futuristic trend started gain momentum since 2010 and up till nowadays, as it widen the possibilities for expressions (*Table 2.*). Words of a song can come with a picture in a variety of ways. The video can defiantly illustrate the content of the text directly or indirectly. But it can also, as in karaoke, duplicate some words. However, creative ideas in video clips are not limited to visual searches as additional sound elements are often used in song clips, which can play not only the role of ordinary noise or speech, but also enhance musical accents or emphasize the musical structure.

Conclusions

Today we can say that we live in a "clip culture". The emergence of the information society E. Toffler considered the consequence of the

The peculiarity of the k-pop industry is that the music industry in South Korea is subsidized by the government. The international popularity of k-pop is closely linked to the government's

deliberate efforts to increase global exports of Korean goods. For example, many k-pop groups record Korean and Japanese (rarely English) versions of the same song, indicating their willingness to adapt to other cultures to expand their popularity. K-pop idols outnumber other international artists in terms of touring and fan meetings. The large base of young fans has contributed to many victories in music nominations and the spread of Korean music around the world. The comprehensive approach to the creation of groups has made a significant contribution (appearance; role in the group, multifunctionality and types; behavior; melodies that can be touched with the first notes and lyrics; vivid visual series; diverse orientation of the thematic series of clips; dance movements).

The specific feature of prevailing majority of k-pop clips is dance trend. It's like a "Korean signature trend". The small clip "cutting" that accompanies the energetic musical pace of the song of a k-pop singer or group, can be speeded up by constant light flashes in this trend. This decision is dictated by the dance orientation of this song material, and it is probably necessary to create an illusion. Though nowadays pop-groups and clipmakers create "masterpieces" with complicated social issues, using symbolic meanings and computer graphics or designs as the media genre "song video" can be called a film put on the music.

South Korea's pop culture is one of the driving forces of youth culture in the Asia-Pacific region today, with a particular focus on China, Hong Kong, Japan, Taiwan and much of Southeast Asia. K-pop in mass culture that promoted the appearance of blue lipsticks and glitter in beauty corners, colored hair (pink, blue, purple), light green, yellow or combination of pink and black (especially for men) in clothing, sparkles on the eyes, false eyelashes, bright eyeliner, daring jewelry, plastic surgery all these are the influence of the Korean subculture. Integrated efforts to promote Korean pop culture, through television and music products, support from the government of creative industries, and collaboration with well-known global brands, have contributed to the international spread of k-pop. Nowadays k-pop influences and shapes American and European culture.

References

1. Arefiev M.A., Davydenkova A.G. (2015). Massovaya kul'tura kak dominantnaya kul'tura globaliziruyushchegosya obshchestva [Mass culture as the dominant culture of a globalizing society]. Proceedings of the St. Petersburg State Institute of Culture and Art. T. 206 Sociology of Culture: Experience and the New Paradigm. Ch. I., 190-196. Retrieved from: <https://cyberleninka.ru/article/n/massovaya-kultura-kak-dominantnaya-kultura-globaliziruyuschegosya-obschestva> [in Russian].
2. Google. Retrieved from: https://www.google.com/search?rlz=1c1chny_ruua887ua887&sxsrf=alekk01pvtwei3zhdneylsnwsrl yv9pygq%3a1589038911004&ei=ps-2xrpnizqrgso5apwdw&q=lady+gaga+is+gonna+to+collabe+with+blackpink&oq=lady+gaga+is+gonna+to+collabe+with+blackpink&gs_lcp=cgzwc3ktywiqddoeccmqjzofcaaagywe6bwgaebqqhwi6ba gaeem6aggaunw2b1jvtgdgtcehaafwahgagahqaygbjgwsaquwljeumpgbakabaqabaaobb2d3cy13axo&scient=psy-ab&ved=0ahukewiz_suej6fpahumtyskhy7yep4q4dudcaw
3. Furtay F. (2009). Yavleniye klippinga v sovremennoy massovoy kul'ture: opyt kul'turologicheskogo analiza [The phenomenon of clipping in modern mass culture: the experience of cultural analysis]. Retrieved from: <https://cyberleninka.ru/article/n/yavlenie-klippinga-v-sovremennoy-massovoy-kulture-opyt-kulturologicheskogo-analiza> [in Russian].

4. Heidi Peeters. (2004) *The Semiotics of Stars: It must Be Written within Music Videos*. London.
5. K-pop. Retrieved from: <https://en.wikipedia.org/wiki/K-pop>
6. K-pop phenomenon: crazy fans, millions of views and its own subculture. Why is the world going crazy with Korean celebrities? (2019) [Fenomen k-pop: bezumnyye fanaty, milliony prosmotrov i svoya subkul'tura. Pochemu mir skhodit s uma ot koreyskikh znamenitostey?]. Retrieved from: <https://super.ru/a/k-pop> [in Russian].
7. Mikael Wood (2019). Where is K-pop going in 2019? *Los Angeles Times*. Retrieved from: <https://www.latimes.com/entertainment/music/la-et-ms-spring-arts-preview-k-pop-bts-blackpink-20190322-story.html>.
8. Skorytchenko K. (2019). Fenomen k-pop: kak koreyskaya pop-kul'tura pokorila ves' mir [The phenomenon of k-pop: how Korean pop culture conquered the whole world]. Retrieved from: <http://russian.korea.net/NewsFocus/HonoraryReporters/view?articleId=174482> [in Russian].
9. Sovetkina, E.V. (2012). Ekranaya klip-kul'tura: vglyad v istoriyu. [Screen clip-culture: a vision of history]. *Bulletin of MGUKI*, 3 (47). Retrieved from: <https://cyberleninka.ru/article/n/ekrannaya-klip-kultura-vzglyad-v-istoriyu> [in Russian].
10. Sovetkina E.V. (2005). *Aesthetics of music videos M., Triada Ltd*, 48 [in Russian].
11. Sovetkina, E. V. (2005). *Esteticheskiye osobennosti muzykal'nykh videoklipov* [Aesthetic features of music video clips]: diss. ... cand. Art criticism: 17.00.03 / Institute for Advanced Studies of Television and Radio Broadcasting Workers at the Department of Screen Art. Moscow. Retrieved from: <https://www.dissercat.com/content/esteticheskie-osobennosti-muzykalnykh-videoklipov> [in Russian].
12. Stacey Jacky. (1998). *Stargazing: Hollywood Cinema and Female Spectatorship*, London; New York, Routledge.
13. Tagg Phillip. (1987). *Musicology and the semiotics of popular music*. Amsterdam; Liverpool: Mouton de Gruyter.
14. Vysotskaya V. (2018). pochemu koreyskaya pop-muzyka pokoryayet zapadnyy mir [K-pop: why Korean pop conquers the Western world]. *Lisa*. Retrieved from: <https://liza.ua/lifestyle/self-development/k-pop-pochemu-koreyskaya-pop-muzyka-pokoryaet-zapadnyiy-mir/> [in Russian].

Halyna Mamus

*Candidate of Pedagogical Sciences, Associate Professor
Ternopil Volodymyr Hnatiuk National Pedagogical University.
Ternopil, Ukraine
orcid.org/0000-0002-5624-2119*

Halyna Havryshchak

*Candidate of Pedagogical Sciences, Associate Professor
Ternopil Volodymyr Hnatiuk National Pedagogical University.
Ternopil, Ukraine
orcid.org/0000-0003-0480-5239*

Iryna Lutsyk

*Candidate of Technical Sciences, Associate Professor
Ternopil Volodymyr Hnatiuk National Pedagogical University.
Ternopil, Ukraine
orcid.org/0000-0003-2943-4358*

Roman Monko

*Assistant, Ternopil Volodymyr Hnatiuk National Pedagogical University.
Ternopil, Ukraine
orcid.org/0000-0002-8641-6925*

**PREPARATION OF FUTURE TEACHERS OF TECHNOLOGY FOR THE
ORGANIZATION OF PUPILS' EDUCATIONAL ACTIVITIES IN THE MODERN
INFORMATION AND EDUCATIONAL CONDITIONS**

***Abstract.** It is determined that the competence in the field of activity, which combines practical expediency and creativity, is fundamentally important for a teacher of labor training and technology. Also the using of information and communication technologies for the organization of educational activities of student is very momentous thing in this case. Examples of updating the content of technological education within the current Ukrainian State Standard, which provides the links between different subjects, flexibility of the educational process and the use of information and communication technologies, are also offered. Methodological bases of use of innovations in the course of professional training of future technology teachers are suggested. It was concluded that due to the lack of clearly defined innovative creative training of student, the overall result of their training in the higher school and the level of activity of teachers' decreases. This indicates the need to make changes in the content of professional training of future teachers of technology for the education students of secondary school in modern information and educational conditions and the development of further researches*

Introduction.

The modern educational environment forms new tasks, goals and challenges. It's a logical and natural process, because the level of development of the world community in the XXI century also has its own distinctive features. Thus, it's inadmissible to stay away from innovative tendencies of world progress, its means, receptions and ways of realization. However, simultaneously, with the informatization of the educational process, scientific leaders pay attention to human values and the prerogatives of feeling beautiful and natural. On the one hand, labor training and education are increasingly out of sight of scientist. On the other hand, other scientists are conducting powerful scientific research with evidence of the benefits of forming positive qualities of the human personality only by means of work.

Increasingly, secondary schools pay attention to subjects, through the addition of which it is possible to form a full-fledged personality, who will be able to think creatively. And at the same time to save the ability to cooperate in a team, satisfy basic human needs. In this case, it is sometimes necessary to break the stereotypes of the modern educational system in order to receive simple life lessons, experience and practice by pupils. It is clear that the generator of these ideas should be a teacher whose activities are responsible also for such implementation. So, the realities of modern society place high demands on the personality of the future teacher of any profile.

For a teacher of labor training and technology, on the one hand, competence in the field of activity, which combines practical expediency and creativity, is fundamentally important. On the other point of view, taking into consideration the current trends of the labor market, a graduate of a pedagogical educational institution must be ready to work in conditions closed to the sphere of production or service.

This specialist must be able to quickly adapt to the new implementations, technological requirements and technical solutions. We mustn't forget that the dominant role in modern society is played by the process of its informatization, which involves mass involvement of methods and modern means of the collecting, processing, presenting, transmitting and storing information which is based on computer technology and information transfer. As a result, one of the main directions of informatization of society is the renewal of education on the basis of information and communication technologies of education.

So, the statements, mentioned above, indicate the relevance of the research topic "Preparation of future teachers of technology for the organization of pupils' educational activities in the modern information and educational conditions".

The purpose of this article is to substantiate theoretically, develop and experimentally test the content and methodological foundations of the professional training of future teachers of technology for teaching pupils in a modern information and educational conditions.

It can be admitted that there is significant amount of researches on this issue. Therefore the addition of information and communication technologies of students' teaching at pedagogical universities is relevant.

We studied the experience of many scientists in various spheres of pedagogical science in the process of our research. There some of them: regularities of formation of personal, professional qualities of the teacher of labor training and technologies (Hevko, 2017; Tereshchuk, 2007; Torubara, 2009); theoretical and methodical bases of implementation of modern information technologies of training in the teaching process of students of engineering and pedagogical faculty (Horbatyuk, 2009; Kukharenko, 2016; Tsidylo, 2015); formation of readiness of future teachers of labor education and technologies for the use of information and communication technologies (Havryshchak, 2011; Mamus, 2009; Petrytsyn, 2017; Urusky, 2016).

Researchers O. Andreev, V. Bykov, R. Hurevych, M. Kademiya, O. Romanyshyna consider research that involves the active use of information, communication and network technologies to be promising, as well as modern means of transmission and exchange of information. The pedagogical aspects of blended learning are revealed in the work of V. Kukharenko (2016); the pedagogical technology of designing of blended learning is offered and recommendations for application in educational process are also developed. The author provides the examples of the addition of blended learning at the university for the training of teachers of labor education and technology.

1. The actuality of updating of youth's labor training.

In accordance to the requirements of society, pupils must learn the features of modern manufacturing (the latest technologies) during labor training and technology. This aspect should pay attention to the knowledge of processing various constructional materials, principles of environmental activities, energy conversion, etc.

The study of the educational field "Technology" is provided by the State Standard of Basic and Complete Secondary Education in Ukraine. The main purpose of this subject is the formation and development of the design, technological, information, communication competencies in order to realize the creative potential of pupils. These aspects determine the substance and the prospects of technological education.

Therefore, the searching of ways solving the problems of technological training of secondary school pupils and future teachers should include not only native experience, but also an analysis of the development of foreign technological education. Due to the impossibility to characterize the peculiarities of teaching a similar subject in different countries because of the limited scope of the article, there are some examples and considerations on the feasibility of making changes in the educational process to train future native teachers of labor training and technology. These very examples are given below.

The experience of the Spanish school Montecastello, located in Vigo, is noteworthy. The management of this educational institution decided to make changes in their work curricula in 2018. Pupils of this school began to study the subject of housekeeping. This fact was considered as the main effective initiative in the fight against gender inequality and the involvement of schoolchildren in basic employment. The boys learnt ironing, sewing, cooking, as well as performing other household chores, such as plumbing and electricity, master carpentry in the offered classes.

The idea came when the school administration was looking for ways to promote gender equality among students. After the discussion, the project was discussed with the parents' and pupils' communities. The parents had no objections to the new discipline, but some children felt uncomfortable when they heard about sewing and ironing. Teachers and parents collaborated and encouraged students. Lessons were taught by volunteer teachers as well as parents of some pupils. Their motto was "Equality is known through action".

The experience of Spanish school demonstrated that the addition of the new subject is very useful for students to learn how to do tasks in order to be ready for future life. So children will be involved in household chores from the beginning and will like the labor.

Modern lessons should be a kind of testing base for the practical application of various subjects; interesting and at the same time accessible for mastering by all students.

Classes in labor training and technology should include links to different sciences. Using knowledge of chemistry, students can justify the choice of construction materials. Mastering the basics of physics contributes to the accessible study not only of the properties of materials, but also the principles of operation of machines and mechanisms, understanding and usage of physical laws that underlie their work. Knowledge of mathematics, biology, history, fine arts, basics of life safety, etc. is required in technology classes. Usually one subject complements another and this contributes to the successful assimilation of theoretical information and the implementation of practical tasks in technology classes.

Learning should be flexible and linked to further professional development, especially in senior classes.

Classes should be organized at a higher scientific and technological level. For example, the laws of physics can be studied on the example of the use of electric current in electrical installation or from the standpoint of mechanical strength in robotics. Students can calculate the optimal location of wiring and lighting system in a "smart home". When studying the basics of "cooking", they should get acquainted with modern technological equipment, training equipment for cooking. Knowledge of chemistry can be deepened and used in the process of cooking and storing food. It is important to be aware with biotechnology, modern food processing, introduction of nanotechnology in cooking, etc.

In the process of studying the module "Technology of interior design" high school students can try themselves in the role of interior designer. However, there is no need to make a shelf, stool or other. While watching videos, students can learn about industrial design, digital modeling and manufacturing technologies. When choosing the topic of their individual creative project and the object to be made, high school students must make the necessary calculations, justify the choice of material. If plastic is chosen for the designed product, the parts can be printed on a 3D printer; if a tree is selected, it is necessary to set parameters for a machine with numerical program control. Of course, such lessons should be conducted on the basis of colleges, lyceums, children's technology parks, centers of innovative creativity today.

It is possible to accustom pupils to non-standard mastering of scientific inventions by involving them in participation in various scientific societies, modern centers of science for youth. For example, "Science Picnics in Ukraine" — interactive experiments in parks, squares, where visitors are introduced to inventors and show that science can be interesting; there they don't present a theory, but reveal the secrets of research in various fields by entertaining.

2. Methodological bases of use of innovations in the course of professional training of future technology teachers

Pupils integrate scientific, technical and artistic activities that have significant potential for the harmonious development of personality in the process of designing and manufacturing products in technology lessons. It is important to get acquainted with modern materials for the manufacturing of products, the peculiarities of their processing, the study of special equipment for practical work, the use of the basics of design and decoration of products with different techniques. Speaking about the informatized society, it is necessary to organize the educational process using the information and communication technologies to teach young people at the appropriate level.

The future teacher must be able to create a database with a variety of projects, he has to work with technical documentation on a computer, be able to make drawings and calculations using computer programs. In addition, it is difficult to imagine modern learning without multimedia technologies by such means: text usage, graphics, video and animation in an interactive mode. These technologies expand the scope of the computer in the educational process. During the practical work, this information will help every pupil to do their individual creative task more successfully.

Social networks have been actively developed, because of the shift of the vector of communication of young people to the Internet sources. The direction and structure, interests and forms of information exchange are their characteristic features. Therefore, it is advisable to use modern domains to form the interest of students. One of the fastest growing social networks is Pinterest, a progressive platform for finding ideas. It is based on the creation of thematic boards. The main tool is the images collected in the tape. Pinterest is world-famous, according to the

statistics: the software environment ranks second place in the number of users among the world's social networks; conversion and CTR in the social network is higher than in FB. The most popular topics — interior, decor, hobbies, cooking. As this software product has gained the trust of millions of users in a quite short time and continues to grow in popularity due to the constant improvement of its capabilities. Its potential features can be used in the educational process of future technology professionals. It's not just about passive use of service ideas, but also creating your own pins and boards.

It is appropriate to highlight the main recommendations that will help to form a cognitive strategy for learning activities particularly at the lessons of technology and generally decorative and applied arts, using the capabilities of Pinterest:

- 1) the use of qualitative content;
- 2) making pupils interested in several boards (experts recommend to use at least 10 boards with 4 pins in each);
- 3) liking the ideas that evoke interest (to like others);
- 4) using of hashtags;
- 5) branding content;
- 6) the work with videos (the usage of video content from YouTube, Dailymotion, TED, Vimeo is allowed);
- 7) captions to pictures have to be left (the qualitative description will accompany a picture after its "stratification").

In the process of studying different modules, such as "Technology of artificial flowers", "Technology of manufacturing gift packaging with textile decor", "Technology of making postcards", "Technology of interior design" in the classes of labor training and technology there are significant resources for improving technical and technological knowledge, practical activities of creative direction using modern domains, platforms for finding ideas.

In the process of studying the module "Technology of making artificial flowers" the basics of creating artificial flowers can be mastered by students of different age, because the process of making them involves the design of simpler and more complex elements. High school pupils can discover the magical world of floral compositions. However, there are no school textbooks and manuals; there is no necessary theoretical information, didactic materials and recommendations. These materials could be used by teachers to prepare and conduct classes. In addition, it is important to involve young people to the design of products using modern materials. Mentioned above indicates the need of updating the content of vocational education, intensification of scientific and pedagogical initiative and creativity, which are aimed to find new reserves of quality training and their competence.

Making artificial flowers is one of the types of decorative and applied arts. Products, made by combining flora objects from different materials, can serve as separate accessories, decoration elements, decorations, souvenirs, etc. The process of their creation is not only interesting, but also is very important for the development of artistic and design abilities and creative potential of the individual.

According to the curricula of bachelor, master degrees, future teachers of technology of engineering and pedagogical faculties study disciplines "Applied creativity", "Workshop on service types of work", "Design of textile products". We believe that the study of material on the design and

manufacture of artificial flowers is possible to be added to the content of one of these disciplines and provide for this approximately 6-8 hours.

To ensure the logic of the presentation of this educational material, students should get acquainted with historical information, the basics of technology of artificial flowers, their place and importance in modern decorative and applied arts, as well as the latest trends in design and floristics.

In order to increase the level of cognitive activity of future teachers of technology, it is advisable to offer an individual research task: to prepare information on materials by using literary and Internet sources. For its successful solution, the teacher can provide indicative topics for abstracts or short reports on the manufacture of flowers of fabric, ribbons, leather, foam; making thematic bouquets, Ukrainian souvenir-wreath, compositions of artificial flowers for interior decoration; women's jewelry and clothing accessories made of artificial flowers, etc.

Thus, it is necessary to take into consideration many factors that develop the personality in order to be involved in creativity. The specialist has not only adapt to the new conditions, but also be able to change it by changing and developing himself. It is important to keep in mind the interests of young people, their personal qualities, inclinations, learning opportunities.

As a result of processing information sources, it is advisable to encourage future teachers of technology to create a common bank of ideas. We provide the example for studying the topic "Design and manufacture of artificial flowers". Depending on the content of the collected materials, it is possible to analyze the information and systematize it: the image of separate colors; samples of the developed instruction cards, technological sequences of manufacturing of separate elements of products; samples of compositions, bouquets, bouquets for clothes, wreaths on the head and wreaths-decorations for rooms, etc.

The future technology teachers, after analyzing the features of similar products for the manufacturing, offer to develop their individual project. It is important to predict the degree of complexity of creating products in accordance to the educational opportunities of each student. In case of necessity, their choice can be adjusted. However, the best result will be in case of correcting this by developing a sketch together.

Depending on their own tastes and wishes, students choose different materials for the design of artificial flowers. Accordingly to this choice, created product designs will be differentiated by the technological complexity of individual operations. The technological sequence of manufacturing products usually includes the following stages:

- making templates for making artificial flowers;
- fabrics and materials preparation;
- cutting of details;
- connection of a flower or composition;
- final processing of the product.

Depending on the materials, selected for the work, it is necessary to justify the control of quality of the product.

The future teacher of technology must be able to help students draw up a plan for the project while organizing and carrying out work on the project. They should discuss the objects of design (individual flowers, compositions of them or complex products with a combination of different techniques for making artificial flowers) . The teacher should be able to adjust the sketches, design and the technology of manufacturing the product depending on the material that is intended. In

order to help students in designing products, the future teacher must have knowledge of design and modeling, technical design, drawing, color, the laws of composition, have an artistic taste to combine individually made elements or colors in harmonious products. Considerable attention should be paid to the study of advanced modern technologies for processing various materials (e.g. foamiran).

Students must know traditional and non-traditional teaching methods in further professional activities and constantly apply them in the learning process. They have to be able to implement a differentiated approach to students, organize work in pairs, in small groups, apply the method of fantasy, the method of creating an ideal object. Students should objectify a method of solving problem situations using the methods of "brainstorming", "focal objects", etc. However, modern education of a young person is inconceivable without the use of information and communication technologies. For example, it is expedient to master CAD (computer-aided design systems) at classes of technological workshop in a higher educational institution of simple designing of furniture. CAD Woody 1.5, developed by the Ukrainian manufacturer Intear, is intended for designing case furniture from a chipboard, DVP, glass. This system can be used not only in production, but also in individual aims. The design of parts is carried out on an orthogonal spatial axial grid, and the final manufacturing of the product is usually performed in axonometric projection. At the same time, the program provides ready-made templates for rapid development of new product models, a database in MS Access format for accounting of basic materials, accessories and other parts. In general, the duration of design depends on the complexity of the design of product parts, as well as the professional skills of the designer. In the end, you can automatically check the correct design of the product.

Modern scientific research, improvement of equipment and technology should be brought to practice in secondary schools classes. Accordingly, future teachers should be able to motivate students and encourage them to learn about inventions and, if possible, master them. For example, the labor training program provides the design of souvenirs, talismans, accessories, etc. A doll, made in the folk style, is one of the most typical examples. However, young people are not always fond of creating a traditional Ukrainian "doll-motanka". Students can be interested in designing a modern designer's doll. The Ball Jointed Doll (BJD) is a doll, to make which hinged hinges and an elastic cord to connect are used. Such "non-standard products" are usually obtained with the help of the 3D printer. You can use the program "RML 3D FACEMAKER", which is offered for non-commercial use. It is freely available and requires only a single web player and browser to run. This program provides a list of facial features that students can manipulate with a slider that can be scrolled with a computer mouse or touchpad. The selected settings must be sent to RML and the face of the nylon doll will be printed on a 3D printer. RML allows you to model a face, print it as a three-dimensional, and then you need just to paint it and assemble it with body parts. Pupils can even design and print flexible plastic clothing for their dolls. But they can sew and decorate it by their own. Thus, students master the latest design technologies along with traditional technologies of sewing and decorating products and in such lessons.

Future technology teachers carry out individual creative projects in various disciplines. However, if necessary, they can combine their activities into a collective interaction. Cloud services are the convenient tool for organizing and implementing collective design.

The various design stages can be performed from any computer that has access to the Internet nowadays. Sending files in small volumes by mail takes time and are inconvenient in order

to exchange information. To solve the problem, it is recommended to synchronize and save files such as Dropbox, Google Drive, OneDrive using cloud services. It is convenient to store project documentation, photos, video clips, etc in cloud sources. In addition, you can set up simultaneous commenting, editing, asking questions to each other and all participants have the opportunity to observe the changes that are made during the implementation of the project stages.

Applying the teaching methods, mentioned above, and introducing information and communication technologies, the teacher will help to increase students' interest to the subject, develop their creative abilities, cognitive activity. An individual approach to the future teacher of technology during the development of their own project forms a number of qualities that will ultimately have positive effect on the formation of the student's character, his attitude to learning and further professional activity.

3. Research aspect.

In accordance to the purpose, set in the article, the study was conducted. It was conducted in the conditions of implementation of the usual educational process in the secondary school and during the training of future teachers of technology.

As a result of an organized conversation with pupils of 10-11 grades, it was found that 92% of them have positive attitude to learning the programs of variable modules in technology lessons.

It should be admitted that all interviewees were interested in the story of modern materials for the manufacturing of products and technology of their processing.

The proposal of high school students to implement homework to collect the necessary information using information and communication technologies for the development of creative projects became unexpected and pleasant.

Besides the survey, analyzed above, there were selected questions for the survey of teachers of labor education and technology and the following results were obtained. 91% of teachers agree with the need of constantly improving the level of knowledge, skills and abilities of artistic and aesthetic orientation for successful professional activity. Almost all respondents (98%) are interested in mastering modern techniques and technologies of manufacturing products. 87% of interviewees thought about the need of practical experience in creating harmony in design and decoration of products with a combination of different materials. Teachers believe that in the classes of labor training and technology it is necessary to combine methods of designing decorative and applied arts and products from modern materials (83%). 31% of teachers of this specialty consider themselves insufficiently competent in the design of products from different construction materials, although they are interested in independent creative search for information from various sources and are constantly improving their professional skills. 91% of respondents want to acquire and apply knowledge and practical skills of aesthetic orientation in the process of creating and decorating products with students. It turned out that high school students like to design and make products of different construction materials, but they understand that they own only certain technique, so 31% of them need constant support and help from the teacher.

The interviewees claimed that they always enjoy the students' prosperous activities in the classroom. Their ideas were clearly defined project ideas and their perfect implementation - the manufacturing of original products that meet the design and technological requirements, the requirements of harmony and beauty.

In addition, there was questioning among the students of the Faculty of Engineering and Pedagogy at Ternopil Volodymyr Hnatiuk National Pedagogical University. These students did

pedagogical practice and gained the experience as technology teachers in 10-11 grades. Future teachers showed interest and desire to teach high school pupils in the programs of variable modules. Some of them (35%) submitted their proposals for the selection of certain modules, improving the content and structure of these modules.

91% of them consider mastering with students "Technology of interior design", "Technology of making gift wrap with textile decor", "Technology of making applications from textile materials and accessories" to be appropriate. They believe that the getting knowledge, skills and abilities in a result of mastering the material of these modules is not only interesting, but can be appropriate for using in everyday life. 87% of bachelors said that they would like to study material that, in terms of its content, involves the design of products by using not only traditional folk crafts. They prefer modern design methods, technologies, inventions of modern materials, art and design. Taking into account, future teachers would like to design products of stylish materials, to study unknown techniques and ways of manufacturing products.

Students submitted propositions for improving classes in the disciplines of "Applied Creativity", "Workshop on service types of work" after the pedagogical practice. 72% of them suggested to search the necessary information from Internet sources additionally to make theoretical or practical part of laboratory works. It will help to prepare abstracts-messages, multimedia presentations, to select videos of carrying out master classes. The learning of something new and unique was the main aim for this group of respondents. 82% of bachelors agreed with the addition of an individual approach to learning in the educational process; development of creative projects of different levels of complexity in accordance with the knowledge and learning abilities of students. For 87% of respondents, it is important to choose an object for the manufacturing: its design, the possibility of choosing different decorations, the use of modern materials and techniques for decorating products.

As a result of the qualitative analysis of the study it is concluded that in the process of developing theoretical foundations or practical work it is necessary to educate future teachers of labor training and technology such features as: perseverance, ability to implement their ideas to the end, improving skills, mastering modern techniques and methods of manufacturing products. Students should be coordinated both to successful cooperative work in the team and individual solution of problems and difficulties to achieve great results.

Conclusions.

As a result of the study, it was concluded that due to the lack of clearly defined innovative creative training of student, the overall result of their training in higher education and the level of activity of teachers decreases. This indicates the need to make changes in the content of professional training of future teachers of technology for the education students of secondary school in modern information and educational conditions and the development of appropriate methodological frameworks.

The introduction theoretical and practical innovations are indicators of reformation of technological education. It will help to develop and adapt future teachers of technology to modern socio-economic realities, make them be able to meet the needs and demands of society.

The innovations, proposed in the article, are given as an example of improving the technological training of young people. Their content is sequent to the requirements of the Ukrainian State Standard of basic and complete secondary education, the content of programs of the discipline.

Qualitative analysis of the study confirmed the feasibility of introducing methodological foundations for the training of future teachers of technology. Taking into account the conditions of the information and educational spheres it allows us to formulate the following advantages of its implantation in the educational process:

– forming and development of design and technological competence of the individual, which is manifested in the process of mastering knowledge about materials of different origins, their production, types, properties, methods of processing and features of working with them. This forming also is presented in the ability to think creatively, make calculations, develop graphic images, improve practical skills of work in the process of technology of manufacturing of products of modern constructional materials with observance of technical conditions and application of the basic methods of work by using modern techniques and ways of manufacturing of products;

– development of informational and communicational competences in the process of creative self-realization of the individual.

All things considered, the preparation of future teachers of technology for the organization of students' learning activities in the modern information and educational conditions should be a purposeful, methodically prepared process. The main aim is to form a creative personality, well-adapted to modern requirements. Its efficiency and effectiveness is provided by all logics of construction of the maintenance of educational process, style of training, the corresponding organizational forms and receptions. The level of professionalism and creative development of the future specialist depend on how they will be considered by teacher and student.

We claim that for further research it is advisable to justify the ways of individual approach to students in the process of studying professional disciplines. Also the need of improving the methodological foundations of technological training should be taken into account.

Reference.

1. Havryshchak, H.R. (2011). The using of computer-oriented technologies of educational graphic activity of students in the pedagogical universities. *Scientific notes of TNPU*, 3, 226-230.
2. Hevko, I.V. (2017). Psychological conditions for the development of professionalism of teachers of technology. *Bulletin of Cherkasy University. Series: Pedagogical Sciences*, 6, 38–50.
3. Horbatiuk, R.M. (2009). *System of professional training of future specialists of engineering and pedagogical profile*. Ternopil:TNPU.
4. Kukharenko, V.M. (2016). *Theory and practice of blended learning*. Kharkiv: Miskdruk.
5. Mamus, H., Pavkh, S., Poniatyshyn, V. (2009). *Using of modern information technologies in the learning process students for art and design activity*. *Scientific notes of TNPU*, 3, 175–180.
6. Petrytsyn, I.O. (2017). *Entering of computer modeling in the process of electrical training of future teachers of technology*. *Youth and market*, 1, 60–64.
7. Tereshchuk, H.V. (2007). *Labor training and education today: losses and gains*. *Scientific notes of TNPU. Series: Pedagogy*, 8, 3-10.
8. Torubara, O.M. (2009). *Formation of readiness of future teachers of labor education for the using of information technologies*. (Master's thesis). Institute of Higher Education of the National Academy of Pedagogical Sciences of Ukraine, Kyiv.
9. Urusky, A. (2016) *Implementation of an individual approach to teaching high school students on the technological profile by means of computer technology*, *Public education*, Kyiv: Science.
10. Tsydylo, I. (2015). *Theory and methods of preparation of future engineers-teachers for the using of intellectual technologies in their professional activity*. (Master's thesis). TNPU, Ternopil.

Hanna Chechelnytska

*Ph.D, Associate Professor,
Department of Psychology and Journalism,
Department of History and Theory of State and Law
University of Customs and Finance (Ukraine, Dnipro)*

Viktorina Antonova

*Ph.D, Associate Professor,
Department of Psychology and Journalism,
Department of Humanistic Education, Philosophy and Customs Identification of Cultural Values
University of Customs and Finance (Ukraine, Dnipro)*

**MODERN UKRAINIAN YOUTH AND HISTORICO-AXIOLOGICAL FEATURES
OF SOCIAL COMMUNICATION**

***Abstract.** The urgent problem of the present stage of the historical development of mankind is the analysis of social communications that determine the value orientations of the modern young people. This issue has been studied in a number of scientific papers. We paid attention to the fact that the era of the emergence of mass communications and information and communication technologies has forever changed the vectors of civilizational development of mankind and its culture. In our study we were interested in young people as active and passive the subject of social communications at the present stage of development is growing the importance of the media, the power of their influence increases. In this context, we opened the issue of the role of social advertising and theatrical events in PR activities. By their spectacle and emotionality, they activate young people to participate in them. At the same time, they serve as an effective mechanism of influence and interaction. In the course of the study, various situational examples were used, including from the life of the university where the authors work.*

Introduction

The urgent problem of the present stage of the historical development of mankind is the analysis of social communications that determine the value orientations of the modern young people. For example, the Young Europe 2017 study on European youth and their attitudes towards a united Europe identified the following most significant values: personal freedom, stability and reliability, skeptical attitude to personal life prospects, pessimistic assessment of the economic situation, frustration the national government. Young people always change the contours of the traditional social values. It is important to understand what they are socially significant perceptions of young people about what is good, justice, patriotism, love, friendship.

Modern scientific discourse reflects the versatility of communicative issues in the modern world, namely: the structure of society (T. Parsons); economic exchanges (J. Baudrillard); broadcasting myths (K. Levy-Strauss, R. Bart); street meeting (A. Giddens); dialogue between the two people (M. Buber); monuments and texts of culture (Yu. Lotman) [6, 157-165].

In a society that has moved to a new level of historical development, quality of life is largely determined by the quality of information an environment that virtually everyone is immersed in today. XXI century with his political and socio-economic cataclysms gradually it supersedes the eternal values of being, generally accepted in all cultures. People cease to perceive good, conscience, justice as valuable the dominant, orientation to selflessness, dignity, reasonableness,

courage, patriotism, value of the person. The modern world is filled with cruelty, selfishness, greed, which gradually supersede human values. Some even ceases to realize that the rejection of truth, honor, love for the people and countries will sooner or later turn to the destruction of the state. Significant role in change the value orientations of society are played by modern mass media. "It is widely recognized that they have long since ceased to be mere means the media. Rather, they are carriers of a specific value system, in the basis of which are the complex processes of cultural alchemy "[14,12].

Analysis of scientific literature.

The era of the emergence of mass communications and subsequently information and communication technology has forever changed the vectors of human civilization and development culture, completing the "Gutenberg Day" (M. McLuhan). Well-known American researcher at the University of California L. Suarez-Villa performs theoretical analysis of modern post-industrialism and believes that in the new social paradigm, the basic values will be the production of intellectual property, knowledge, creativity. The question of axiological component in the functioning of the information-communicative environment and the interaction of the media with the value system of society was reflected in the works of scientists J. Habermas, S. Cohen, N. Luman, S. Hall, K. Tester, N. Stevenson, A. Kapto, as well as A. Bashuk, V. Vladimirov, O. Hrytsenko, N. Zrazhevskaya, V. Ivanov, S. Kvit, V. Korneev, N. Kostenko, O. Kuznetsova and others. Noteworthy are the studies concerning axiological issues in mass media. This is primarily the work of scholars such as S. Cohen, S. Hall, K. Tester, J. Habermas, N. Stevenson, who consider the problem of the relationship between moral values and the media.

Axiological issues in mass communication are addressed by I. Annenkova, V. Berezin, I. Erofeeva, Y. Miroshnikov, T. Naumenko, O. Polikarpova, L. Svitich, V. Sidorov, G. Solganik, E. Pronin, O. Pronina, O. Ustimova, V. Uchenova, D. Hovalig. They focus on the axiological function of mass media, the expression of national values of Russian culture in media text, the worldview principles of journalists. Interesting are the works of modern researchers who study certain aspects of axiology of mass media, among them - A. Bashuk, V. Vladymyrov, O. Hrytsenko, N. Zrazhevskaya, V. Ivanov, S. Kvit, V. Kornieiev, N. Kostenko, O. Kuznetsova, V. Lyzanchuk, Y. Los, B. Potiatynyk, T. Prystupenko, V. Rizun, K. Serazhym, O. Serbenska, Yu. Finkler, N. Shumarova. They consider problems of representation of values in mass communication, value-ethical regulation of journalistic activity, emotional-expressive saturation of media materials.

In the information age, the recipient, according to scientists, learns a day more new than his ancestor has learned in his entire life. However, the significant flow of information circulated by the media is negative. This is evidenced by news in Ukraine and in the world, beginning with disappointing information about the COVID19, which has filled news of legal, cultural, economic, political and social nature. Moreover, acts of terrorism, wars, accidents, natural disasters are, unfortunately, the realities of our lives that reflect the media. However, the war that journalists are talking about is nowadays becoming more and more a product of the media, and it is unfolding more in the virtual plane than in reality. According to many researchers, because of the considerable flow of negative information, modern society can become, as it is unfortunate to admit, mentally ill. K. Jung warned about this in his time: "The future of humanity will be faced not so much with the threat of overpopulation or nuclear catastrophe, but with the danger of a mental epidemic"[18]. And that obviously because a person is surrounded by a variety media texts, comes under their influence. It is worth mentioning only the first weeks the dissemination of information about the COVID19 and the response of people to this news.

To say it was a public panic is to say nothing. After all, the negative streams of information can cause a whole spectrum of negative psychological states: anxiety, helplessness, nostalgia, fear, hatred, contempt, anger. This, in turn, can aggravate aggression behavior of recipients, reduce their sensitivity to cruelty, form an image of social reality, not quite adequate to reality. Of course not it can be argued that all recipients are perceived as being aggressive information will show hostility or anger. The media audience is not homogeneous, indivisible, whole. It is presented separately ethno-cultural, socio-cultural, socio-psychological groups, different by preferences, values, interests, needs, and more.

In our study we were interested in young people as active and passive the subject of social communications at the present stage of development is growing the importance of the media, the power of their influence increases. Previously, the authors investigated certain aspects of this scientific problem based on the research project 0120U101504 (registered March 5, 2020). We also express our gratitude to those students, Polozhai Maryna, Kozlova Sofiia, who have proved that young people are interested in this topic.

Results

1. The role of social advertising in the process of forming the worldview of modern youth. Today, the mass media have acquired a status of social value as the main source of knowledge for most of society. Accumulating a system of moral and ethical dominants that "grow" into the minds of the mass audience, they not only determine the value priorities of society, but also change them. As the main conductors of media information, they form myths and stereotypes, and thus determine the nature of people's relationships and moods. In this context, special attention is paid to the problem of theatrical events in PR activities, with their powerful emotional impact, visual expressiveness.

In recent years, there have been negative shifts in the value system in Ukraine: traditional norms of morality and behavior are almost destroyed and new ones have not yet been formed. Today, there are changes in the content of many traditional virtues. For example, the entire range of values associated with professional activity has changed. The main axiological characteristics of recent years have been the volume of wages and production stability. The so-called vocation, the usefulness of the profession, the enjoyment of work satisfaction have fallen into the background. Choosing their future profession, modern entrants are primarily concerned with the prestige of the specialty and passing points, despite even the specifics of the specialty they want to master.

When asked: "Why did you enroll in higher education?" - from 100 interviewed students answered: 2 - to study science, 5 - parents were forced and 93 - to have a prestigious job and a high salary (Ukraine today. - 2009. - No. 25. - April 2). During the introductory campaign of previous years, there were cases when one applicant simultaneously submitted documents to 5 or more (!) faculties, without even thinking about the specifics of the chosen specialties. The main thing, according to one of them, "to enter university, to get a piece of paper about higher education, and there it will be seen." Of course, it is difficult to get a college education today, because the cost of education is not affordable for many.

When choosing a future profession, you should consider your preferences, abilities, opportunities. It is axiomatic that anyone who has received medical education at the request of their parents will not always be a doctor. Sometimes it seems that the criteria of good and evil are being blurred.

Recently, one can observe a tendency of reorientation of traditional spiritual and cultural values and value orientations of the Ukrainian people to Western European models. Of course, the latter contain both positive and negative value dominants. However, in any case, focusing on the traditions and culture of other peoples is a borrowing that generates secondary, derivative, cloned values. Moreover, today there is an orientation primarily to the samples of Western low-grade, not elite culture.

As a consequence, many moral virtues, including responsibility, honesty, kindness, and sensitivity, which cause the dominance of consumer values, which testify to the regressive dynamics of axiological consciousness, the movement from post-materialistic to materialistic values, are receding into the background. In this situation, what is most worrying is that replicated anti-values can become entrenched and become dominant in the system of life-orienting youth. Therefore, today we should pay special attention to those factors that actively influence the formation of spirituality. Well-known American sociologist and futurist A. Toffler, in the preface to the collection "Values and the Future" (1969), wrote that before humanity today open wide and varied opportunities for further development. However, what future it chooses will depend on the values that govern human behavior. One can further this view by noting that the future of humanity is largely dependent on the values broadcast by the media. After all, in the information society, the media take on a special status: by engaging with mass audiences, they actively promote worldview principles and stereotypes, replicate sociocultural values, promote the traditional system of moral and ethical dominant or, conversely, stimulate their transformation.

Researchers of mass communication processes for a long time did not pay attention to the axiological role of the media. Among the main functions of mass communication are traditionally distinguished information (translation of events around the world), regulatory (impact on society and its knowledge through feedback), culturological (preservation and transmission of cultural heritage from generation to generation), which once proposed H. Lasswell. The axiological role of the media in communication was discussed at the end of the last century, turning to the study of moral panic and ethical issues of the media. S. Cohen was one of the first to address these issues, analyzing the concept of "moral panic" in his research. Panic is understood as an exaggerated, media-reinforced social reaction to relatively insignificant actions of social deviation.

Sometimes something completely new becomes the subject of panic, and sometimes something that has existed for a long time but has suddenly become the focus. In some cases, panic goes away and is forgotten, remaining only in folklore and collective memory; in others, it has profound and long-lasting consequences and can lead to changes in, say, legal and social policies, or even in public consciousness. According to S. Cohen, this situation arises when a condition, event, person or certain groups of people begin to be characterized as a threat to social values and interests. Recognizing the significant role of the mass media in creating a moral panic, the scientist says that the media themselves decide whether it is moral or immoral by affixing a label of deviance.

Problems of moral panic addressed in the late 70's of the twentieth century a group of British socioculturists from the Birmingham Center for Cultural Studies, led by S. Hall, came to the conclusion that some of the information in the mass media texts automatically makes readers and viewers nervous.

K. Tester, in the mid-1990s, went beyond the study of moral panic, greatly expanded the field of axiological studies of the media and sought to find out how the media convey moral values and influence their content. According to him, the media can be agents of moral progress and the

transmission of moral virtues, but this should not lead to the unequivocal conclusion that the media really play such a role. K. Tester is convinced that research on morality and the media should be based on the understanding that the media cannot be considered on its own, outside the socio-cultural context. It is in the context of the complex interplay between media and society that one can explain why media audiences remain somewhat passive before the good or bad of what they watch, do, and what they like.

On the need to saturate the communication space with positive information, journalists also emphasize on the pages of print publications. In particular, A. Tarnarutskyi, Coordinator of the Good News Association, notes that “in our life, negatively colored news cannot be dispensed with. But if we only focus on them and refuse positive messages, then we also sin against journalistic objectivity ”(UM. - 2009. - No. 63. - April 7). V. Niankin, correspondent of Sumy newspaper Panorama, states in his material "Joy of man": “People stopped visualizing a positive idea about the future ... We, small people, are not able to defeat the current crisis with economic methods of an all-Ukrainian scale. Our chance is to dismantle this wall of negativity brick by brick, erecting your monument from positive emotions.”(Panorama. - 2009. - No. 11 (535). - March 11–18).

The concept of social advertising is usually associated with solving socially important problems, namely the change of stereotypes of behavior of individuals, the formation of certain moral and ethical values [7]. Its difference from commercial advertising is that it is aimed at the development and formation of the moral and spiritual aspects of society. It is not only about its influence on human behavior, formation of its outlook and moral qualities, but also its relationship with the conditions of political, economic and cultural processes in general.

At the present stage of development, domestic social advertising has a wide range of opportunities, which are unfortunately not used enough [8, 48]. An analysis of the current state of social advertising in Ukraine shows that citizens and professionals are skeptical about its effectiveness. Apparently, people who do not have sufficient knowledge and experience in advertising, sociology and psychology are often involved in the creation of such advertising, which is extremely important for developing truly effective social factors. Usually, they do not work, because when they pay attention to a particular problem, they do not offer real and effective ways to solve it. In addition, sometimes social advertising causes unwanted reaction from the target audience, in particular young people, that has the opposite effect. Advertising campaigns of this kind are characterized by poor diagnosis of social problems, due to the fact that they are funded by the authorities and businesses on a residual basis. On the agenda is the formation at the state level of such a system of social advertising, which would ensure the interconnection of objects and areas of influence, in order to use it to significantly enhance the physical and spiritual and moral potential of modern Ukrainian society. The main subject of the socio-economic system is human beings. Therefore, the physical and moral health of every citizen is of great importance for economic development and for social progress as a whole. In this regard, the promotion of healthy lifestyles is an extremely important area of social advertising.

First of all, it is a problem of bad habits, such as smoking, alcoholism, drug addiction. They, we guess, cause a significant deterioration in the health of Ukrainian citizens. Many scientists and public figures have rightly called smoking, alcoholism and drug addiction problems that threaten the national security of the country. Smoking has become a mass and popular activity, which has increased the profits of cigarette makers, but has caused and will cause great harm to health, especially to women and children. There are already attempts to counter this phenomenon through social advertising.

For example, the legislation of other countries in Ukraine stipulates that cigarette packs should have an inscription that smoking is harmful to health. However, today such warnings are stopped by many, and young people usually do not take them seriously. One example is the US-based Truth Company, which promotes a new nicotine-free style and offers alternatives to smoking. EU countries have banned the promotion of tobacco products on television. Italy already has a complete ban on all forms of tobacco advertising. In the UK, not only any direct advertising of tobacco products is banned, but also financial support to tobacco companies for sporting events.

Modern anti-tobacco advertising is ineffective because social behaviors of the smoker population are virtually ignored. In our opinion, the main focus of the impact of social advertising in Ukraine should be women whose health and appearance of smoking is particularly detrimental. This will reduce the incidence of children and additional health care costs, meaning that it can be counted on to have a significant economic impact. It is necessary to use specific methods of influence, taking into account the features of female psychology. It's no secret that the most important thing for most women and girls is the attractiveness, the search for a decent life partner. Nowadays, many women in Ukraine and in the world consider smoking a factor that facilitates dating with men.

In the early twentieth century, women's smoking was associated with depraved, debauched and low levels of social status. Starting in the 1920s, stereotypes about smoking's association with women's attractiveness, independence and success were created thanks to the first advertising campaigns for women's cigarettes Lucky Strike and Philip Morris. This notion should be changed to create another form of attractiveness for the female image, demonstrating the negative attitude of men towards women who smoke. And vice versa.

New momentum is needed for anti-alcohol advertising. Alcoholism is not only the cause of family conflicts, but also leads to an increase in diseases among the younger generation, an increase in mortality, mainly in the male population. However, as in the case of tobacco, modern anti-alcohol advertising is limited to the label on the packaging of alcoholic beverages: "Excessive alcohol consumption is detrimental to your health." This phrase is written in a hard-to-read and slow-response font, which is why it has no significant effect on consumer behavior. It is necessary to take into account the socio-psychological characteristics of the age group of consumers of beer and other alcoholic beverages.

These are mostly young people who have not yet realized the value of health. Therefore, it is logical to emphasize in anti-alcohol advertising that excessive consumption of alcohol leads to a complete degradation of personality and loss of socio-cultural status.

The problem of drug addiction is becoming increasingly relevant. At present, media and government officials are not paying enough attention to this issue. Young people should be clearly aware of what they are condemning themselves to, since the maximum life expectancy from the start of drug use is only 7-10 years.

In addition, they can be dragged into the underworld, with a high likelihood of getting infected with AIDS and other dreaded diseases. We need to be reminded of this all the time. In our view, social advertising should promote a healthy lifestyle. Increasing life expectancy is not an end element of social advertising. It must also find its natural continuation in the development of the moral potential of the nation. Physical and spiritual development should be considered in their unity and inseparable connection. In general, we are talking about a revival on a whole new level of Hellenic tradition "in a healthy body - a healthy spirit".

Thus, it is necessary to promote the humanization of society. Humanism is manifested in the revival of the traditional sense of goodness and empathy for the Ukrainian people. Active and comprehensive advocacy for humanity, charity and mutual assistance is needed. For a humane society involves the desire of all its individuals to be happy.

2. Theatrical activities in the process of social communication and public relations

2.1. Theoretical basis for the use of theatrical activities in the process of social communication and public relations.

Theatrical events can be considered as a means of personal development, they are a direct reflection of all changes in society in any field of it (political, social, educational, religious, moral, ethical, ideological, economic, cultural... etc.). That is what they must meet all the needs of the modern young personality.

There are many definitions for the term 'pageant'. To use the term in the field of PR, we propose to use the following definition: "Theatrical event (action / spectacle) is the embodiment of creative thought through the creation of artistic images, which aims to convey a certain idea to the viewer, with the use of ideological and emotional influence in the script . "

When preparing for a pageant, one must keep in mind the specific requirements that exist for the event to be as successful as possible and to achieve its goals.

First, it must be remembered that an event only acts as a tool to achieve a specific goal. Thus, the spectacle should form the necessary settings in your viewer, create the appropriate mood and evoke experiences, which in turn are appropriate to the goal. Secondly, you must strive to attract the optimum number of participants in the event. These can be not only spectators but also those directly involved in the organization of the spectacle. In this way, everyone will be able to show their abilities, knowledge and talent.

When preparing for a mass event, one must take into account the age, and therefore the mental characteristics of the viewer (target audience). The event should capture its participants (audience), depending on the form of material that was selected and the activity of the viewer in action. The more you engage the viewer in directly engaging in the spectacle and the more clearly you submit the material, the more it will affect the atmosphere and the perception of the main idea. Last but probably the most important requirement for theatrical action: "The play should end a little earlier than it gets bored" [4].

The success of the spectacle depends not only on the directorial talent of the director, but also on the main presenter who sets the mood of the event. The success components of a good presenter are:

- Ability to connect with an audience;
- Taking into account the individual age and mental characteristics of the viewer;
- High level of general erudition, skill in a specific theme of the event;
- Understanding the laws of the scene;
- Speech culture, "delivered" voice;
- Ability to creatively solve non-standard situations [4].

Of course, the presence of the presenter, although not a necessary factor in the creation of a theatrical act, facilitates its implementation. Even if the event starts spontaneously and aims to attract viewers at the expense of unexpected performance. The presenter may appear at the end as a point of concentration and explain to the public the purpose of the spectacle, to present the event organizers.

Therefore, on the basis of the presence of the presenter, there are 2 types of theatrical events: 1) with one or more presenters (these are usually complex events that include multiple performances that require the announcement of a title, performers, etc. Examples include various professional awards: Oscar, MTV Music Awards.) 2) without presenters (flashmob, pseudo theatricalization).

When planning and writing a scenario for a future event, the filmmaker and screenwriter must consider certain features of the spectacle. Yes, it is very important to determine the place where the action will take place, because the technical possibilities at the makeshift playground in the park are much different from the technical capabilities on the stationary stage of the opera house.

Much attention should be paid to the artistic organization of space. The space on the stage of the concert hall is two-dimensional, and the viewing point is one, given by the ramp, the position of the stage and the auditorium. In turn, the space, such as a stadium, is three-dimensional and has a circular view. The spectacle of the stadium is perceived by the spectators from all sides, and therefore the design of the decoration should be built in accordance with this feature. When creating a spectacle at a stadium, the director must take into considerations not only the space of the stadium itself, but also the peculiarities of its environment, which affects the overall perception of the space by the viewer. It is very difficult for the production manager to keep in mind that keeping the entire stadium attention, with a capacity of tens (sometimes tens) of thousands of spectators, is very difficult, so it is important to determine the focus points in advance - the anchor points that will facilitate the mass spectacle [2].

Sometimes, if the pageant is a mass event, it is necessary to organize the distribution of audience attention. If during a theatrical performance on stage the focus of attention is in one place - the stage, then during mass celebrations (fairs, open days, festivals) it is necessary to create a polycentric model that contains several entertaining centers, each of which can hold its own attention a large number of viewers. This system allows you to maximize the impact on your audience in a crowded environment. In addition, this model makes it much easier to avoid accidents due to the large number of people involved [2].

Thus, when creating a script, the director should consider the following factors:

- Event Tasks (an idea to convey to the audience);
- The venue for the spectacle (stadium, city street, makeshift playground in the open air ... etc.);
- The scale of the event, the number of spectators;
- Material resources (the bigger the budget - the bolder ideas of the director and screenwriter can be realized) [2].

Before writing a script that requires any action, you need to define the concept. It will become the nucleus of future text. The concept can be compared with the frame around which the arguments, facts, illustrations are subsequently attached [4].

Having decided on the concept of the event, you can begin the process of building a script composition. Like any literary genre, the script should have the following elements: prologue, plot (introduction), main action (action development), culmination, finale, aftereffect (optional).

Building a script and installation structure for such an event in the PR industry requires a combination of different components. Here, the scenario is constructed in a spiral, where each number (as an element of the spiral concept) is independent, but vertically ascending to the

culmination of the spectacle (ie to the top of the spiral - the main event of the event, which usually expresses the idea of its conduct).

The prologue (exposure) is the beginning of the event, the introductory part of the script [3]. The beginning of the event is very important. The prologue is intended to prepare the spectator for the spectacle, to set the mood, atmosphere. Prologue is defined as a short emotional action [4]. This action is intended to intrigue the viewer, make him stay and watch the sequel. To do this, apply certain techniques:

- Verbal. It can be a dramatized scene, a discussion, a sensation, an extremely unusual news story (a poem on a theme, reading a letter or an order, presenting respectable guests);
- Ritual. As a rule, it is represented by various ceremonies and traditions (bringing a flag to the hall, meeting with bread and salt, lighting a fire, relay transmission, a moment of silence);
- Musical. This may be fanfare, an orchestra performance with a country / organization official / unofficial anthem.
- Prologist. A video or clip showing clips of a video, photo, according to the theme of the event.
- Application of technical effects. It is one of the spectacular types of prologue that can be represented by a salute, the launching of balls, the ignition of a large number of festive lights and garlands or emblems[4].

The main part is usually represented by various spectacular numbers of theatrical character: choreographic and vocal performances, pantomime, humorous opera. When creating a theatrical act, we need to remember that this is a show. It should capture the viewer, give him some thought, if you need to omit any elements in the composition chain related to the action, conflict, and climax - then you can use it. However, the idea of focusing on the laws of constructing a composition is still necessary.

Final (outcome). The main purpose of the finale as a structural element in the composition is to summarize, measure the event. It is very important to combine "hall" and "stage" in a single ritual action (final song, dance, dedication) [4].

One of the characteristics of a mass event is the powerful emotional impact on the viewer, which is usually sought by a PR industry employee by organizing such events. The fact is that being in a crowd, people for a while lose themselves as an independent unit and become part of the crowd. In this case, actions, feelings and thoughts of one are directed by the collective, a mass consciousness emerges.

Through the skillful application of the means of ideological and emotional influence, one can achieve the effect of the greatest influence on the collective consciousness, which will have its imprint in the individual. Such events include music, cinema, light, sound, mass scenes, pyrotechnic effects, symbolism and color, etc. [4].

It is the skill of the director that depends on the logical and skillful combination of all the above elements that help to create a holistic, aesthetic spectacle with the necessary emotion. On this basis theatricalization is based - the expression of the content of the material by the means of the theater, the opening of the dramatic conflict and the creation of the artistic image of the performance) [4].

It is believed that this particular condition makes it possible to call the event theatrical. In any other case, it will be a mere spectacle, without idea and purpose.

The director of the theatrical event may be a PR specialist himself or a hired worker with special education.

When it comes to pseudo-theatricality, then, as a rule, PRs model the situation independently and explain to the customer: what to do, what emotions to show, how to behave in unusual situations. The customer also acts as the main actor. However, if you are looking at specific performances that can be used to attract the maximum number of viewers to a contact, then you need to hire a dedicated staff member to perform the director's role. In such a situation, employees are usually employed as well.

The use of theater as a method is not included in the list of basic methods in PR. However, it is impossible not to notice how often theatrical measures are used today in order to attract the maximum number of people and to promote a certain idea. The theatrical method involves the expression of an idea that the customer wants to convey to the public through the methods of theater. Creation of artistic image, spectacular show, choreographic and vocal performances. Examples of such events include charity or sponsorship concerts organized by businessmen to maintain their positive image.

Moreover, it is suggested to understand not only the play of actors on stage when everyone around the world realizes that the theatrical sketch is being played, but also the "hidden" play when the real person gives the feelings, thoughts and actions of the lyrical hero for his or her own. In this way, the person playing the role is misleading the audience. Sometimes planned actions, as if a theatrical sketch, appear to be true events, in order to achieve certain goals for the promotion of the product (service, personality) and to retain a certain image in the eyes of society.

The episode that took place on September 23, 2004, during the political contest of the two main candidates for the presidency of Ukraine, is a bad example of such a game. At that time, Viktor Yanukovich's political technologists tried to stage an attempt to assassinate their ward. Coming out of the car, Viktor Yanukovich had to "give a sign", after which it was planned that the politician would simulate the fall from the bullet. However, no one predicted the actions of a student, Dmitry Romanyuk, who threw an egg at V. Yanukovich. Thinking that this was a "sign" (a shot was fired by an idle cartridge), Viktor Fedorovich grabbed his heart and fell to the floor. Of course, bodyguards quickly picked up the politician and put him back in the car. This event had been widely discussed in the media and had become almost a canonical example of the unsuccessful work of political technologists. Ratings Yanukovich had fallen sharply to a critical minimum.

In such cases, as mentioned above, there is a problem of morality in the use of theater as a method of promoting the individual (organization, firm). However, the possibility of a "black" PR as a means of combating a competitor cannot be excluded. Although it is considered a quasi-form (distorted form) of the classic "white" PR, it is still widely used in the modern world. That is why we can only study it as an integral part of PR as a whole.

2.2. Theatrical event as part of event marketing.

By classifying theatrical events in PR activities it is suggested to start from event marketing. Event marketing is the organization of events for mass and corporate events. Mainly corporate events are aimed at strengthening the inner spirit of the company, for holding mass events designed to support powerful promotions and PR-campaigns, which may also include the organization of tasting and raffle [15].

The main purpose of event marketing is to engage the audience in the inner world of the organization. That is, the entrepreneur tries to present his brand, corporate values and privileges of

his own product. The main emphasis is on the organization of special events aimed at promoting and supporting the image of the product (business, personality) through the creation of bright, exciting and interesting events: shows, presentations, concerts, parties, conferences.

This promotion method has a list of benefits. Event marketing gives the impression to the buyer that the entrepreneur is paying attention to the customer, which in turn elicits a positive response. A pageant organized by an entrepreneur (firm, individual...) becomes a "brand" in itself. This in turn allows it to be widely used in further promotion (PR) of the customer.

Often, during the show itself, the manufacturer (entrepreneur, firm...) is provided with a convenient way to test their product or service. In this case, those who attend the event act as a focus group. Thus, the entrepreneur has the opportunity to save on research, not to mention that it is possible to arrange direct sale of products during the action. Sometimes it is even possible to interactively sell sales into a script. For example, offer the audience an auction to buy the product to continue the storyline.

An important benefit of event marketing is allowing it to be used even in situations where direct advertising does not work or is completely prohibited. The strong flexibility of this type of PR allows you to write a variety of scenarios, depending on the budget provided by the customer. Competently produced theatrical event as an element of event marketing makes it easy to achieve the goal, provided the right choice of the target audience, as well as the selection of the event to the psychological requirements of viewers, according to age.

Starting from the idea that a pageant in a PR can be considered an integral part of event marketing, it is suggested to take a classification similar to the relevant one.

Classically, event marketing is divided into: educational (seminars, trainings), sports (competitions, sports competitions, tournaments of various sports), entertainment (shows, concerts, festivals), business (congresses, exhibitions, presentations). [3]

Therefore, theatrical events can be divided according to the context in which they take place. This classification will include a breakdown by application:

- Educational (lectures on open days, demonstration of simulated situations at trainings, graduation at schools and universities...);
- Sports (opening / closing ceremonies of sports competitions, olympiads, tournaments, competitions, sports and recreational events with elements of theater with the participation of spectators...);
- World-class entertainment (shows, concerts, festivals, performances of show-ballets at parties, discos, dance evenings, balls, celebrations of solemn events, fairs, beauty pageants...);
- Commercial and business (opening and closing ceremonies for film festivals and exhibitions, fashion shows, fairs, opening ceremonies for new construction sites (laying the first brick), open days);
- Pseudo-theatricality. They are usually arranged in the political or public sphere to promote a particular individual. Companies and businesses can sometimes be advertised in this way, but the main action will still be down to the action participants, who in turn are usually the top executives of these companies or other workers (the emphasis is on the specific employee, his actions and thoughts are identified with the company in which he works). Such pseudo-theatricals try to make them as resonant as possible so that as many media as possible pay attention to them (but a possible variant of the ordered materials in several well-known media, the so-called "jeans").

2.3. Practical implementation of the proposed classification of theatrical actions in the field of university PR (by example UCF). This section presents examples from the life of the university and Ukraine as a whole, to which the classification proposed in the previous section can be applied. Terms of observation: 2018-2019 academic year, the first semester of the 2019-2020 academic year. The main criterion for evaluation is the venue (according to the classification).

a) Educational and commercially theatrical events

One of the most interesting examples of the merger of two types of theatrical event, namely educational and commercial business, is the Open Day at the University of Customs and Finance.

Such measures fall into two categories precisely because they have several basic functions. To define such an event as educational enables us the fact that an event takes place within the walls of an educational institution and the main task of such an event is to inform the entrants and their parents (guardians) about the professions that the student can master within its walls.

Usually, on the walls of the University of Customs and Finance, students prepare various trainings, stage numbers that represent their specialty and student life as a whole, in order to interest the future student. In the course of a pageant show in the form of, for example, performances by a team of drummers, future entrants receive additional motivation to enter this university because of the opportunity to become part of this group and to engage in interesting activities for a number of classes free of charge. In this case, thanks to the theatrical performance in the form of a performance by a team of drummers, the university gains a competitive advantage over other universities (provided that the same or almost identical overall indicators).

In its turn, the Open Day at the University of Customs and Finance can be attributed to a commercially business type of pageant. Here, the other side of the classification is more representative, namely the purpose of the event. The main purpose of the Open Day is to attract the maximum number of entrants to the application process. Thus, the university fulfills its commercial purpose - to receive tuition fees.

b) Entertaining theater events

The most obvious kind of theatrical event is secular entertainment. Examples include a variety of fairs: the Sorochinsky Fair, the annual charity fair at the University of Customs and Finance. The last event was mentioned on the website of the Ministry of Education and Science of Ukraine [16]. Usually, the fair is not only a sale of goods, but also a whole theatrical phenomenon. To take the Sorochinsky Fair specifically, it can be said that it not only allows artisans to sell their rather specific goods directly, but also serves as a PR campaign for the organizers, in the form of local patrons who spend their own expenses on organizing the fair. Here theatrical events in the form of nativity scenes and choreographic numbers also increase the number of spectators. These activities perform several functions at once: PR organizers (in the form of local deputies, patrons ...). A good place to advertise sponsors who have helped in the organization (companies, businesses, corporations ...). Direct sale of artisans products at the fair. Of course, it is beneficial for each of the presented groups to have the maximum number of spectators. And it is the variety of theatrical events that give you the desired effect.

Thus, based on theoretical assumptions and specific examples, we classified the types of theatrical actions in social communication, pointed out their entertainment, emotionality. These characteristics create a channel of communication with youth for the transmission of value guidelines.

Conclusions

The image of modern man, unlike other historical times, is formed not only under the influence of traditional cultural and spiritual values, but also under the influence of the media. In this paragraph of the monograph, we paid attention to the fact that the era of the emergence of mass communications and information and communication technologies has forever changed the vectors of civilizational development of mankind and its culture.

We noticed that the media audience is not homogeneous, indivisible, integral. It is represented by separate ethnocultural, sociocultural, sociopsychological groups, different preferences, values, interests, needs, etc. In our study, we were interested in young people as an active and passive subject of social communications. Also, we covered the issue of whether today the mass media as the main source of knowledge for most of society acquire the status of social value. Accumulating a system of moral and ethical dominants that "grow" in the minds of the mass audience, they not only determine the value priorities of society, but also change them, determine the nature of relations and moods of people. In this context, we opened the issue of the role of theatrical events in PR activities. By their spectacle and emotionality, they activate young people to participate in them. At the same time, they serve as an effective mechanism of influence and interaction.

In Ukraine in recent years, this was discussed at the beginning of the paragraph, there have been negative changes in the system of values: traditional norms of morality and behavior are almost destroyed, and new ones have not yet been formed. Today there are changes in the content of many traditional virtues. For example, the whole set of values associated with professional activities has changed significantly. Wages and stability have recently become the main axiological characteristics. The so-called vocation, the usefulness of the profession, the enjoyment of work have receded into the background. Therefore, choosing a future profession, modern entrants, we believe, are primarily concerned with the prestige of the specialty and passing scores, despite even the specifics of the specialty they want to master.

No one is surprised by the tendency to reorient traditional spiritual and cultural values and value orientations of the Ukrainian people to Western European models and standards. Of course, the latter contain both positive and negative value dominants. However, in any case, the focus on the traditions and culture of other peoples is a borrowing that generates secondary, derivative, cloned values. In addition, today there is a focus primarily on examples of Western low-quality, rather than elite culture.

The authors believe that a significant problem is that many moral virtues recede into the background, including responsibility, honesty, kindness, sensitivity, which causes the dominance of consumer values and shows the regressive dynamics of axiological consciousness, the movement from postmaterialist to materialist values. In this situation, the most worrying thing is that the replicated anti-values may become entrenched and become dominant in the system of life goals of young people. Therefore, in this study, we paid special attention to the factors that actively influence the formation of spirituality, tried to analyze the qualitative axiological course and understand the positive shifts of mass media vectors that occur in recent years.

References

1. Anisimova, O.(2013). Sotsialna reklama — fenomen ukraïnskoho informatsiinoho prostoru. Naukovyi poshuk molodykh doslidnykiv (sotsialni komunikatsii): Zbirnyk naukovykh prats studentiv, 3, II, 5-12.
2. Boiko, A. (2013). Masove sviato i yoho komponenty. Lektsiia dlia studentiv II kursu, spetsialnosti khoreohrafiia, z dystsypliny: «Orhanizatsiia i rezhysura sportyvno-masovykh khoreorafichnykh zakhodiv», 7.
3. Harmider, L., Orlova, A. (2014). Podiiievi marketynh yak instrument prosuvannia natsionalnykh brendiv tovariv i posluh. <http://www.economy.nayka.com.ua>
4. Herman, O., Railian, O. (2007). Orhanizatsiia masovykh i teatralizovanykh sviat. Metodychni rekomendatsii, 17 s. <http://www.zomc.org.ua/vidannya/item/1557-metodychni-rekomendatsii-orhanizatsiia-masovykh-i-teatralizovanykh-sviat>
5. Kurban, O. (2007) Sotsialna reklama: derzhzamovlennia, rynok marketynhovykh komunikatsii chy sfera hromadianskoi vidpovidalnosti suspilstva? . Dzerkalo tyzhnia, 28 kvitnia, 25.
6. Nazarchuk, A.(2011). V. Ideya komunikatsii i novyie filosofskie ponyatiya XX veka. Voprosy filosofii, 5, 157-165.
7. Nikolayshvili, G.(2008). Sotsialnaya reklama: teoriya i praktika, 1-191.
8. Nifaeva, O., Nehamkin, A.(2013). Sotsialnaya reklama kak faktor ekonomicheskogo razvitiya. Mirovaya ekonomika i mezhdunarodnyie otnosheniya, 5, 48-55.
9. Oltarzhevskiy, D.(2016). Sotsialna reklama : navch. posib. Instytut zhurnalistyky KNU imeni Tarasa Shevchenka, 1-120.
10. Piskunova, M.(2004). Sotsialnaya reklama kak fenomen obschestvennoy refleksii,19-36.<https://elibrary.ru/contents.asp?id=33276515&selid=11735905>
11. Teatralizovani diistva yak zasib rozvytku osobystosti. <https://studfile.net>
12. Rezhiserskiy postanovochniy plan. <https://studfile.net/>
13. PR. <http://www.marketch.ru>
14. Saenkova, L. (1997). SMI v kontekste ponyatiya «massovaya kultura». Zhurnalistika v perehodnoy period : tezisy mezhdun. nauch. konf., 2, 12.
15. Slushaienko, V., Hiriievskia, L. (2009). Sotsialna reklama: svitovyi dosvid ta ukraïnski realii. Visnyk Natsionalnoho tekhnichnoho universytetu Ukrainy «Kyivskiy politekhnichnyi instytut». Politolohiia. Sotsiolohiia. Pravo: Zb. Nauk. prats, 4, 1-193.
16. Studenty UMSF razom z uchniamy dniprovsykh litseiv provely blahodiinu aktsiiu “STUDENTSKYI YARMAROK”. 9 october 2018. <https://mon.gov.ua/ua/news/studenti-umsf-razom-z-uchnyami-dniprovskih-liceyiv-proveli-blagodijnu-akciyu-studentskij-yarmarok>
17. Toffler, A. (1999). The Third Wave.
18. Yung K. (2001). Psihologicheskie tipy.

Nelia Dehtiarova

Candidate of Pedagogical Sciences

Associate Professor, Department of Computer Science

A.S. Makarenko Sumy State Pedagogical University

Yulia Rudenko

Candidate of Pedagogical Sciences

Department of Computer Science

A.S. Makarenko Sumy State Pedagogical University

Sergii Petrenko

Candidate of Pedagogical Sciences

Department of Computer Science

A.S. Makarenko Sumy State Pedagogical University

PEDAGOGICAL DESIGN IN E-LEARNING

Abstract. *In the modern world, the organization of the educational process, e-learning is becoming more relevant. Modern education demonstrates the need for electronic platforms for distance learning, global network resources, electronic materials. This is true for all specialties, but for future teachers, higher education should combine various forms of training: full-time and electronic, traditional and mixed. The popularity of distance learning using digital technologies and web services can have two consequences: oversaturation with them and refusal of this type of training or increase in efficiency. Therefore, the correct approach to the organization of distance learning courses, which is based on pedagogical design, is important. The pedagogical design involves the creation of educational materials for distance learning with optimal cognitive load. The principles of pedagogical design: student motivation, a clear and concrete statement of the goals and objectives of the course; compliance with the quality requirements for the presentation of new material; implementation of training support; students gaining experience through practical exercises; flexible and timely feedback; the proper organization of monitoring the achievements of students. A balanced pedagogical design of a distance course will provide student motivation, interest in learning, and the quality of knowledge.*

Introduction.

All participants in the modern educational process are ready for change and need it. Modernization of education is increasingly associated with the introduction of distance learning. Currently, the concept of "distance learning" is expanding to "electronic". According to the general recognition of educators in many countries of the world, e-learning is the most promising way of educational progress. The market of educational services has acquired a new meaning with the advent of the opportunity to study remotely on the principles of democratization, accessibility, differentiation. And the situation in 2019-2020, associated with long-term global quarantine, confirmed the importance of implementing e-learning. Obviously, e-learning needs more attention in the training of future teachers, who will later be the authors and developers of such courses. In recent years, a large number of scientific papers have been published that consider the essence, methods, tools, features, principles of electronic and distance learning. For example, studied:

- technologies for creating a distance course V.Yu. Bykov, V.M. Kukharenko (*Bykov, 2008; Kukharenko, 2012*);
- methodological aspect of distance learning problems I.H. Herashchenko, N.V. Herashchenko (*Herashchenko & Herashchenko, 2019*);

- electronic and technical component of distance learning Yu.V. Holovanova (*Holovanova, 2011*);
 - Features of e-learning administration, the role of tutor I. Katerniak (*Katerniak, 2016*);
 e-learning in the context of globalization, transnational programs for validation and mobility of graduates Vorobiova O.P., Mukhodinova K.M. (*Vorobiova, 2018; Mukhodinova, 2017*).

Thus, e-learning combined with traditional learning may be the most effective form. Therefore, it is necessary to pay attention to the distance form, which can later be used in the training of future and current teachers.

The problem of the correct and pedagogically balanced use of digital technology in the classroom still remains unresolved. We formulated the tasks: to study existing research in the field of e-learning, to consider the principles and stages of pedagogical design when creating a distance course; consider the features of cognitive load in e-learning.

The purpose of the article: to determine the essence, principles, features of pedagogical design when creating a distance course.

1. E-learning. Modern challenges

The process of acquiring knowledge and skills with the use of ICT was defined as e-learning by speakers from UNESCO (*UNESCO - United Nations Educational, Scientific and Cultural Organization - a specialized institution of the United Nations Educational, Scientific and Cultural Organization*) (uk.wikipedia.org & uccs.org.ua).

Definitions of e-learning can be found in various publications. Each author tries to clarify it, detail it, justify its vision. We can such summarize (cde.kpi.kharkov.ua; *Sharov & Sarova, 2019*):

E-learning is a form of learning using various e-learning resources and environments, electronic media, network technologies, mobile communications. E-learning includes all forms of education and teaching technologies, as well as multimedia learning, learning development technologies; posted on the computer: instructions, training; computer (automatically) generated instructions or consultations; online learning; web learning; online education, virtual education through virtual learning environments (virtual environments are also called learning platforms), mobile learning and digital educational projects (*Vebster, 2002; Cross, 2003; Vovk, 2015*).

E-learning used at different levels:

- the easiest - the use of presentations, Office programs, e-mail, messengers;
- intermediate level - it is knowledge, skills and experience of using Web 2.0 services: LearningApps, Kahoot, ClassTime, environments for creating crossword puzzles, bookmarks, puzzles;
- high level of mastery - is the organization and support of distance, blended and individual learning by specialized means (Moodle, Google Class, Zoom) with awareness and consideration of the psychological perception of educational material in electronic form; inclusion in the course of platforms of educational courses (Prometheus, Coursera, etc.).

Distance learning (DL) is one of the components of e-learning. The main idea of distance learning is the use of tools that provide methodological guidance to the learner.

The essence, implementation and features of the organization of distance learning contained in the "Regulation on distance education" approved by order of the Ministry of Education and Science of Ukraine (zakon.rada.gov.ua/laws/show/z0703-13). According to this provision, distance learning is defined as "individualized process of acquiring knowledge, skills, abilities and ways of human cognitive activity, which occurs mainly through indirect interaction of distant participants in the learning process in a specialized environment that operates on the basis of modern psychological and pedagogical and information and communication technologies". The organization of distance learning includes the following components:

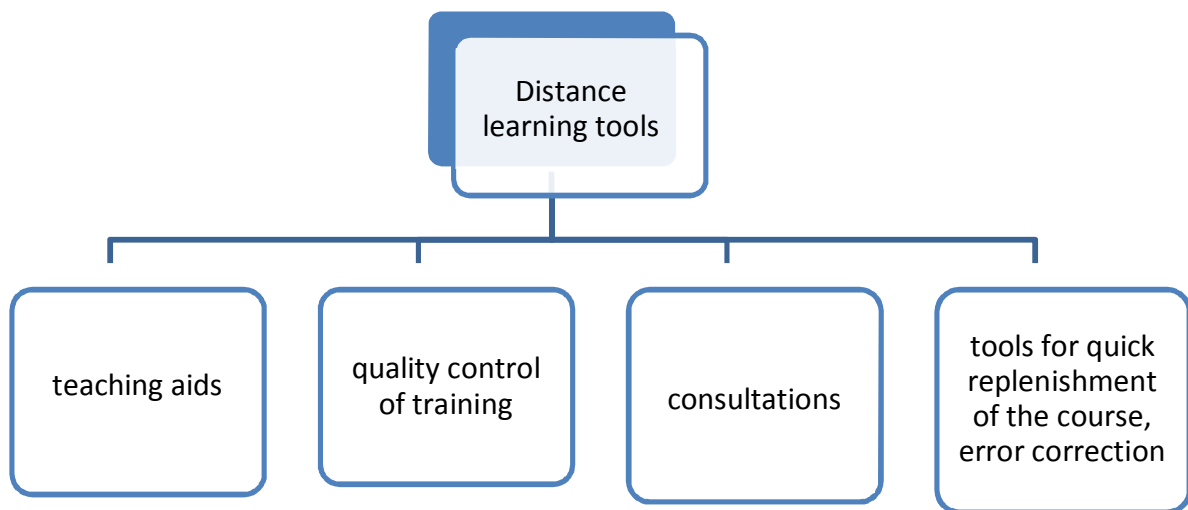

Fig. 1. Distance learning tools

In distance learning, a number of such typical psychological and pedagogical problems have been identified: difficulties in establishing interpersonal contacts between participants in the process; the problems of the formation of practical skills in teaching particular subjects; difficulties in determining the individual characteristics of the perception of information; maintaining motivation for learning; high level of student responsibility; correspondence of teacher behavior to the chosen teaching methods.

Distance learning can be both an independent form of learning and a component of full-time or distance learning.

The question arises: is it possible to introduce DL in teacher training? How can replace traditional learning with distance learning? And is it always necessary to do this? Distance learning in any course requires careful and detailed planning of the organization of this process, clearly defined goals and objectives, as well as self-organization of the student.

Regarding the use of distance learning for students, the following areas can be considered effective:

- electronic support for core courses of the main program for students;
- in-depth study of the thematic course for those interested and additional education on interests;
- certification training;
- retraining.

The quality and effectiveness of distance learning largely depends on how teachers conduct classes in an interactive network. The teacher must be versatile, have the latest pedagogical methods, have special training for working in the information environment and be an innovator in the field of digital technologies.

The main component of effective distance learning for any field is pedagogical design.

2. Pedagogical design as a condition for the quality preparation of a distance course

It is obvious to everyone that e-learning in the future will only increase pace of development and dissemination. At the same time, there is already a rejection of such funds that do not meet modern requirements and demand. It are long unstructured texts, boring lectures, complex descriptions without video.

Developers of distance learning courses require a deep understanding of the psychological, cognitive characteristics of the training material, methods of motivation and effective elements of knowledge quality control. That is why pedagogical design comes to the fore in the creation of a distance course.

Pedagogical design is a field of science and practical activity based on theoretical aspects of pedagogy, psychology, ergonomics. The main task of pedagogical design is to develop such educational material that will provide a rational, comfortable and effective learning process (*Denisenko, 2015; Korthagen, 1993; Pogromska, 2014; Piatakova & Danilishina, 2010*).

The technology of pedagogical design is to understand the needs of students, to determine the goals of education, to transfer knowledge and information as efficiently and accurately as possible.

Preparatory stage in the development of the training course, the selection of the main elements and details includes a pedagogical design. In distance learning, it is important not only to present information qualitatively, but also to ensure its perception by students. Qualitatively presented information is formed into knowledge that will be applied in professional activities. Therefore, it is important to follow the principles of pedagogical design:

- motivation, interest of students in educational material;
- clear and specific explanation of the goals and objectives of the course;
- presentation of new material (since the complexity and selectivity of the perception of new information is inherent in the human psyche, it is necessary to provide elements that will retain attention and provide knowledge in the most accessible form);
- learning support (provide mechanisms for retaining information in the long-term memory of the student);
- gaining experience through practical activities (parallel constant application of acquired knowledge in practice will allow to clearly and effectively link the theory and its application);
- feedback (flexible and prompt feedback is required for operational analysis of course teaching methods);
- assessment of the success and quality of acquired knowledge;
- help the student in the correct application of the acquired knowledge (transfer of practical skills to new conditions, not limited by the course).

Stages of pedagogical design are implemented in a clear sequence:

1. Analysis of needs, competencies of students, expected results;
2. Defining the goals and objectives of the training course;
3. Analysis and structuring of materials in accordance with the objectives;
4. The choice of means and methods of learning environment;
5. Creating elements of style and visual design of the course;
6. Development of lectures, tasks, methods of control and collection of information;
7. Downloading the course into the learning management system
8. Development of methods for evaluating results
9. Decision on further improvement of the training course and their implementation.

We present the methodology of pedagogical design when creating a distance learning course. Numerous studies show that the effectiveness of the perception of media objects by users of a distance learning course is distributed in the following ratio.

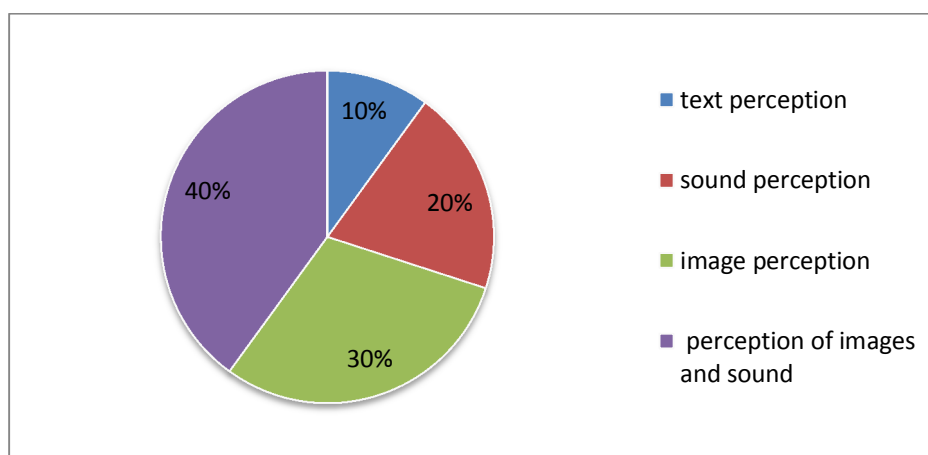

Fig.2. Perception of multimedia objects

The psychological features of the perception of text on the monitor screen, the variety of content (graphics, video, audio) force the distance course developer to adhere to such rules. When adapting the text of the course to the screens, it is necessary to take into account two components of the perception of the text: external and internal. The visualization of the text (technological component) belongs to external perception. These are the sizes, colors of fonts, length of sentences, paragraphs, width of the text, styles of headings, lists, illustrations, external defects.

Internal perception - the organization of the text, its structuring (pedagogical component).

Must remember about the ratio of quality and quantity when creating a distance course. Often the requirement to quickly create a course is reflected in its quality. Short terms and big size of the course lead to formality in its creation. For example, electronic textbooks, which are the basis of many distance learning courses. In most of them, an e-textbook is a book in PDF or HTML format, the capabilities of which are limited by the ability to follow links to the required paragraph. To ensure the main requirement - the acquisition of knowledge, it is important to take into account the psychological patterns of perception, memory, thinking, attention, as well as practical skills of students. Therefore, the electronic textbook must have a high level of design, technical performance, be logical, visual, consistent. It should not just be a collection of theoretical materials and hastily formed test questions. Such a source should become, "grow" into a self-teacher, able to replace the teacher (Bilousova & Zhytienova, 2010).

Requirements for the e-textbook for distance learning, summarized from various scientific publications, are presented in the table

Table 1. Requirements for electronic textbooks

Requirements	Content
Level of difficulty	Provides differentiation of training
The principle of "quantization"	Breakdown into minimal modules that are logical and meaningfully complete
The principle of clarity	Provided by the use of audio, video files, hyperlinks.
The principle of branching	The ability to select a transition on any hyperlink for a detailed study of certain concepts, a return to the previously studied
Knowledge test	Various, accompanied by comments, there is the possibility of instant results
Additional help	The presence of tooltips
Directory	Implemented using hyperlinks
Updating material	Dynamic, timely

When creating electronic textbooks, the developer must know the methods of using software, be able to professionally use computer tools (*Semenikhina&Kudrina&Udovichenko&Shamonia, 2017*).

The readiness of a teacher for professional activity by means of electronic educational resources should be based on the principles of scientific, guiding and cognitive information, phasing, return to previously studied, feedback, appropriate computer support (*Udovichenko, 2018*).

It should be added that electronic textbooks, like traditional ones, do not solve the problem of self-acquisition of knowledge. And the lack of experience of independent work, lack of self-discipline and self-awareness complicate the process of learning. It is necessary to take into account the need to create psychological comfort between the student and the teacher.

Psychological comfort in the learning process is achieved in interpersonal communication. The teacher of a distance course, in modern conditions of educational space has a huge load, and is not always able to pay adequate and comprehensive attention to each student. A virtual communication barrier is a psychological barrier to the relationship between the participants in the learning process. The presence of such a barrier can distort or change the content of the material, affect the understanding of the information contained in it, the behavior, thinking of the student, reduce his self-esteem and motivation to learn. Thus, the personal characteristics of distance learning teachers and the organization of timely and complete feedback are important to ensure the psychological comfort of students.

Third, in distance learning is difficult, and sometimes even impossible, to keep students motivated. Motivation is an internal process that is based on personal motives that motivate an individual to make an effort to achieve learning goals.

It must be acknowledged that a significant number of modern students have reduced motivation to study for various reasons, such as: studying in higher education institutions is not for a profession,; atrophy of motivation due to excessive consumption of information on the Internet; choosing a specialty or institution not at one's own request, but at the request of parents, etc. And although the responsibility for motivation rests entirely with the student, the teacher's task is to stimulate it (to evoke, support, develop those impulses that induce motivation), which is much more difficult in distance learning. Factors that can provide motivation for independent activity are: responsibility, interest, educational and cognitive and professional interests, own pace of learning, fear of expulsion, and so on. The combination of motivation and stimulation is the key to a truly effective learning process. And this is possible with the organization of comprehensive e-learning and face-to-face training.

Only highly professional teachers can provide a distance course. It is important for teachers to adhere to academic quality standards, which includes:

- full compliance with academic standards;
- definition of minimum academic requirements and their description in such a way that they are understandable to students;
- organization of final testing.

Having analyzed the best practices for solving the problems of creating and providing a distance course, we can say that an effective form of training for future teachers is a form of blended learning. By definition, "blended learning" is a combination of formal learning tools (work in classrooms, organization of pedagogical practice in educational institutions, study of theoretical material) with informal (testing, online conferences, webinars) (*Krivosos & Korotun*).

It combines both traditional and interactive methods, enhancing the benefits of distance learning and reducing its disadvantages. It provides an opportunity to use distributed information and educational resources in stationary learning with the simultaneous use of elements of asynchronous and synchronous distance learning. Thanks to the mixed form at the invariable purposes, means and methods of their achievement become more effective. New possibilities appear in the system of diagnosing knowledge: the use of control systems in combination with traditional methods. It is obvious that, with the introduction of modern teaching methods in the educational process, it is possible to significantly improve its quality, make it more flexible, stimulate students to work independently.

Thus, preparation for the inclusion of elements of e-learning in the traditional should begin with an in-depth analysis: the objectives of learning, didactic opportunities of new technologies for the transmission of educational information, the requirements for distance learning technologies. It is necessary to take into account the age and level of knowledge of students, features of specific disciplines.

3. Cognitive load theory

When developing a distance course, it is important to make sure that the material is understandable to students, used in practice and useful. The human brain stores information in structures built on logical connections.

Therefore, it is important to use learning technologies that help structure and memorize material. So, it is necessary to consider the theory of cognitive load.

The theory of cognitive load is a theory according to which a person is able to effectively process and memorize material under the condition of rational effort. Because a person's short-term memory can store a limited amount of data at a time, it is important to present the material in doses. The more information presented in a lecture, the less likely it is that it will be memorized and used in future practice. The following principles of the theory of cognitive load are applied:

- reducing the amount of secondary material and unnecessary repetitions (they create an additional load on the working memory);
- use of visual and sound methods;
- when developing certain skills, such tasks or examples are used, which do not require many actions, but the result will be the formation of a specific component of competence;
- Combining information from different sources in one place.

In the event of cognitive overload, students will make mistakes, be distracted, tired, and, as a result, will not be able to master the course material. To avoid the effect of cognitive overload, the following methods should be used:

- use hyperlinks to secondary facts, additional explanations, examples, repetitions, which are managed by the student;
- apply schemes, illustrations, the loss of which is not reflected in the content of the course;
- use infographics that distribute educational material between information processing channels and reduce cognitive load;
- the presentation is dosed - the study material is divided into modules, and the transition to the next level occurs only after mastering the previous lesson (*osvita.ua*).

Undoubtedly, the total use of distance learning tools during long-term quarantine has become a mass experimental test of all previously formulated hypotheses and recommendations by various researchers. The shortcomings that accompany this form of education (*osvita.ua*) have become obvious:

1. Principles of academic integrity - complicated identification of students taking a distance course. It is quite difficult to check who passes the tests and performs various types of training work on the other side of the computer.

2. Imperfection and bandwidth of the Internet, especially in remote areas.

3. Poor quality of teacher-student contact due to excessive professional workload of teachers.

4. Low readiness and motivation of teachers to implement distance learning.

5. The complexity of an objective assessment of knowledge, limited verification.

6. Difficulties in conducting practical classes that require the development of any applied skills.



7. Problems with self-discipline, motivation of students to study and perform tasks.

Thus, the introduction of e-learning elements involves the preparation of materials in electronic form, a professional approach to working with distance learning platforms, correct and appropriate use of global network services.

This is the reason for a conscious approach to the correct formulation of tasks and questions. The types of questions that can be used when creating tests on educational platforms are presented in the table.

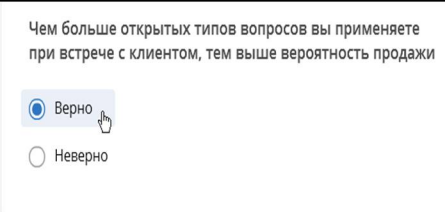
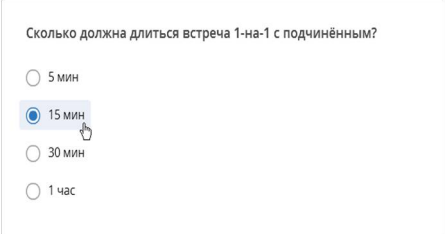
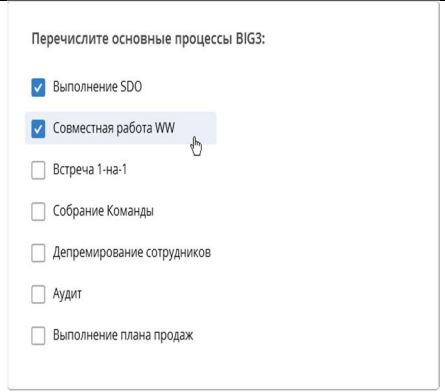
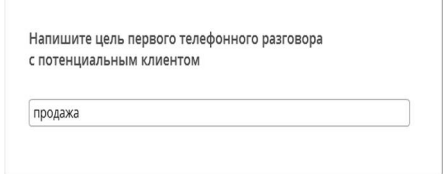
Table 2. Types of questions in tests

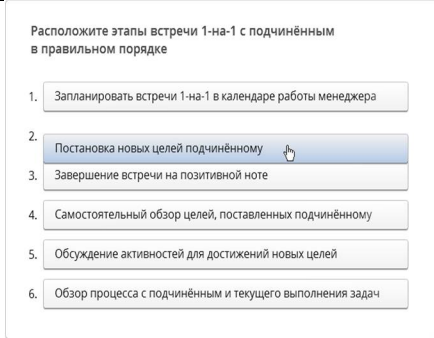
Question Type	Explanation	Visualization
Yes No	You must choose the correct or false statement	
Choice of one answer	It is suggested to choose one answer from several	
Multiple choice	You must select multiple answers from the list	
Short answer	You must enter the correct answer in the text box	

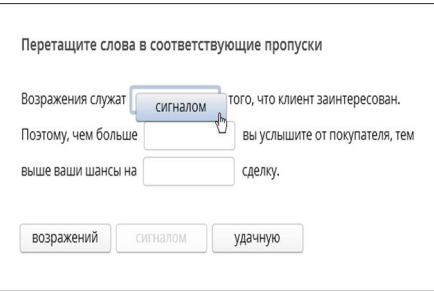
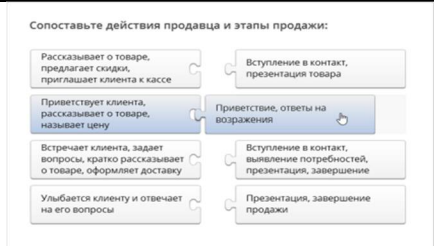
Sequence establishment	You must place the items in the correct order	
List selection	You must select the correct answer from the drop-down list	
Moving words	It is necessary to choose the correct answer from the bank of answers and to put in the text in place of omissions	
Conformity	You need to connect a couple of words, sentences or images.	

Despite the benefits of e-learning, there are disadvantages:

- dependence on Internet quality;
- technical problems that arise due to overloading of educational platforms;
- low motivation of some students to distance learning and lack of parental control;
- prolonged stay at the computer can be harmful to health;
- the inability to determine exactly who did the task (student or someone else);
- the inability to determine how much time the student has to spend at the computer to do all the tasks;
- the general availability of communication in networks and the exchange of information leads to plagiarism and fraud,
- it is impossible to really determine the level of students' knowledge without lively communication.

Conclusions.

The market of educational services has acquired a new meaning with the emergence of the opportunity to learn remotely with the principles of democratization, accessibility, differentiation. E-learning has become an integral part of the educational process and requires special attention.

The study of some problematic issues on the introduction of e-learning in the educational process gives grounds to formulate theses.

1. E-learning is a form of learning using various electronic learning resources and environments, electronic media, network technologies, mobile communications.

2. Given the professional level of the teacher / lecturer, the organization of e-learning is divided into levels: low (presentations, work with files of different formats, the use of e-mail, messengers); medium (Web 2.0 services); high (organization of distance, blended and individual learning, use of e-courses).

3. Inclusion of elements of e-learning should begin with an analysis of the objectives of learning, didactic capabilities of new technologies for the transfer of educational information; requirements for distance learning technologies; age and level of knowledge of students; features of academic disciplines.

4. Provides the quality of perception of the discipline in the virtual space of pedagogical design. The main task of pedagogical design is to develop such educational material that will provide a rational, comfortable and effective learning process.

5. The stages of designing a distance course and the principles of pedagogical design are defined in the work.

6. Knowledge of the principles of pedagogical design and features of cognitive loading will allow the teacher to create a quality and useful distance learning course.

References

1. Bykov, V. Yu. (2008). Distance learning. *Encyclopedia of Education of Ukraine. Acad. Ped. Sciences of Ukraine*. K.: Jurinkom Inter, 191-193.
2. Kukharenko, V.M. (2012). Theories of learning at the present stage of development of distance learning. *Theory and methods of e-learning. Issue 3*. Kriviy Rig. Publishing Department, 153-161.
3. Kukharenko, V.M. (2012). Development of distance learning at the present stage. *Scientific Bulletin of the National Academy of Statistics, Accounting and Auditing. Coll. Science. Issue. №2*, 117-121.
4. Herashchenko, I.H. & Herashchenko, N.V. (2019). Distance learning in conditions of economic uncertainty. *Studia Humanitatis. № 4*. <http://st-hum.ru/content/gerashchenko-ig-gerashchenko-nv-distancionnoe-obuchenie-v-usloviyah-ekonomicheskoy> (date of application: 09.05.2020)
5. Holovanova, Yu.V. (2011). Methods of distance education: causes and methods of solving the problem. *Pedagogy: traditions and innovations: materials I International. scientific conf. (Chelyabinsk, October 2011). CH. 2*. Chelyabinsk, 114-116. <https://moluch.ru/conf/ped/archive/19/1001/> (date of application: 09.05.2020).
6. Katerniak, I. (2016). Guide to the preparation and organization of e-learning. K.: LLC "Painted sheet", 48 p.
7. Vorobiova, O.P. (2018). Ensuring the quality of e-learning in the European Higher Education Area. *Information technologies and teaching aids. Volume 64. №2*, 245-252.
8. Mukhodinova, K.M. (2017). E-learning. Its advantages and development in the future. *Marketing and controlling: modern challenges of business*. K., 132-134
9. UNESCO. *Electronic encyclopedia*. <https://uk.wikipedia.org/wiki/UNESCO> (date of application: 11.05.2020)

10. Tasks and purpose of UNESCO. <http://uccs.org.ua/zavdannia-ta-meta-iunesko/> (date of application: 11.05.2020)
11. The concept of e-learning development. (2009). http://cde.kpi.kharkov.ua/cdes/new/Conception_eL.pdf (date of application: 13.05.2020)
12. Sharova, T. & Sharov, S. (2019). E-learning: an effective format of education. http://eprints.mdpu.org.ua/id/eprint/6064/1/Sharova_Sharov_2019_119.pdf (date of application: 13.05.2020)
13. Vebster, F. (2002). Information society. *Theories of the information society*. Cambridge: Routledge, 255-266
14. Cross, J. (2003) Informal Learning. <http://www.internettime.com>
15. Vovk, O.B. (2015). E-learning systems - new forms of modern education. *Mathematical machines and systems*. № 3, 79-86
16. Regulations on distance learning. *Order of 25.04.2013. № 466*. <https://zakon.rada.gov.ua/laws/show/z0703-13>. (date of application: 10.05.2020)
17. Sneghurova, V.I. (2009). Distance learning models in secondary education. <https://cyberleninka.ru/article/n/modeli-distantsionnogo-obucheniya-v-sisteme-srednego-obrazovaniya>. (date of application: 10.05.2020)
18. Dontsov, A.V. (2008). The moral culture of the reader. [Monograph]. *X. : KhNU imeni V.N. Karazina*. 240 p.
19. Denisenko, S.M. (2015). Pedagogical design in an ordinary process. *Newsletter of the Zhytomyr Sovereign University of Ivan Franko*. № 3 (81), 79-83.
20. Korthagen, F. (1993). Two Modes of Reflection. *Teaching and Teacher Education*, №9, 317-326.
21. Pohromska, H.S. Principles of constructivist approaches to learning in the concepts of foreign scientists. *Scientific Bulletin of MNU named after O. Sukhomlinsky. Pedagogical sciences*. Issue. 1.47 (114), 218- 222.
22. Piatakova, H.P. & Danilishina, M. (2010). Philosophical and theoretical principles of formation and development of higher pedagogical education in the USA and Ukraine. *Proceedings. Series: pedagogy, № 2*, 151-157.
23. Bilousova, L.I. & Zhytienova, N.V. (2010). Use of computer support in teaching natural sciences and mathematics. *Theory and methods of e-learning: a collection of scientific papers. Issue I. Kryvyi Righ: NMetAU Publishing Department*, 13-17.
24. Semenikhina, O.V., Kudrina, O.Yu., Udovichenko, O.M. & Shamonina, V.G. (2017). Professional readiness to use electronic educational resources: an analytical criterion. *Physical and mathematical education: a scientific journal. Issue 4(14)*, 87-91.
25. Udovichenko, O.M. (2018). Preparation of future teachers of computer science for professional activity by means of electronic educational resources: *author's ref. dis. ... cand. ped. science: 13.00.04. Sumy: SumDPU named A.S. Makarenka*, 20 p.
26. Krivonos, O. & Korotun, O. (2015). Blended learning as a basis for the formation of ICT competence of the teacher. *Proceedings. Series: Problems of methods of physical-mathematical and technological education. Issue 8(11)*, 19-23.
27. Distance education: advantages and disadvantages. <http://www.osvita.org.ua/distance/articles/18/> (date of application: 10.05.2020)

Oxana Nefedchenko

Instructor of foreign language

Sumy State University

Sumy, Ukraine

orcid.org/0000-0003-1656-2422

RESEARCH OF THE MAIN COMPONENTS OF HEURISTIC EDUCATION IN UKRAINIAN PEDAGOGY

Abstract. *The article is based on the research of Ukrainian scientists of pedagogical universities, dedicated to the development and implementation of innovative educational techniques that contribute to the development of personality's creative self-realization in the context of a heuristic, dialogized educational process. The purpose of the work is to find out the essence and content of the Ukrainian scientists' researches devoted to the development, improvement and application of innovative, mostly heuristic, educational techniques in practice. Such techniques are aimed at supporting personal growth, creative self-realization of educational subjects and introduction of modern heuristic dialogue. Using such methodological approaches as systemic, synergetic, acmeological and comparative-comparable, critically-reflexive, analytical-synthetic methods essential tendencies and problems in the development of techniques of innovative pedagogical education were revealed, the need to develop new heuristic, acmeological, dialogical techniques was clarified. It was revealed the efficiency of use of heuristic and acmeological techniques for the development of self-realization of either growing up personality or teacher, the expediency of the transition from a monological educational system to a dialogical that develops motivation, cognitive-creative, research competence at all stages of the educational process.*

Introduction.

The formation of Ukraine as an independent state, the reform of all sectors, including higher education, imply an orientation to the person as a personality capable of self-realization of cognitive-creative and professional-creative qualities. In the context of rapid restructuring of the educational process to replace the traditional, mostly monological education, innovative education comes with new techniques and methods of organization, above all, the process of teaching students and pupils. In our opinion and the opinion of many scholars (V. Andreiev, A. Korol, B. Korotiaiev, A. Khutorskoi, etc.), which we support, it is heuristic education that combines the cooperation of all subjects of teaching, the discovery of new knowledge through dialogue between students and teachers, their constant self-improvement and self-realization in the form of creating educational products, should occupy a central place in the modernized educational system.

The need to deepen certain aspects of research in heuristic education and its techniques required the identification of major educational problems that have become the subject of research in the first decades of the XXI century.

The analysis of studies of native and foreign scientists gives grounds to consider the main components of heuristic education as its target, content and technical components:

a) creative self-realization of the individual (*target component*), revealed in the works of V. Lozova, A. Maslou, K. Rodzhers, A. Khutorskoi etc.;

b) multilevel cognitive and professional creativity of all members of education (*content component*), researched in some works of V. Andreiev, I. Ziazium, B. Korotov, M. Lazariev, M. Nikandrov and other authors;

c) heuristic dialogue (*technical component*), the studies of M. Bakhtin, A. Korol, L. Krivshenko, K. Lazarijeva, I. Protsenko are devoted to it. The origin of such dialogue dates from ancient philosophy and pedagogy.

1. Heuristic dialogue as the technical component of innovative (heuristic) education

During the research of the work of Ukrainian scientific schools, it has been found that the problem of revealing the essence, functions, conditions of using heuristic educational dialogue as one of the leading components of heuristic education is, of course, an indispensable way of improving the quality of education of students and pupils.

Oleksandr Kuzmenko performed one of the first PhD thesis on the problem of educational dialogue “Organization of educational communication of pupils at a lesson-seminar” in 1997. This work justifies the system of “ways and techniques that are aimed at creating favorable prerequisites for educational interaction of pupils, providing this interaction pedagogically appropriate in order to improve the quality of educational and cognitive activity” (Kuzmenko, 1997, pp. 7-9).

In this research, the development, justification and testing of flexible and multidimensional, heuristic in its direction and content technique lesson-seminar, which created the preconditions for intensive educational communication of pupils, became really new and important for the development of heuristic educational techniques. First of all, they are driven by the high demands placed on them by this form of teaching. The types of independent educational and cognitive activity at the seminar are not familiar to the pupils and are closely related and involve complex implementation. Thus, the study of the recommended literature became a condition for the preparation of an independent author's notes, which become the basis for the preparation of such educational products of pupils as reports, abstracts, reviews, annotations. Preparation of written creative production is a prerequisite for successful participation in the discussion. If, in order to participate in the first seminars, it is usually sufficient to be able to work with a textbook, to translate, to give examples, then in the future it was necessary to have a complex set of various general and subject skills. The intensive character of this form of education, its structural, functional and methodological features is stimulated by intensive communication at the school-seminar. The didactic goal is achieved here for a relatively long time. Working a few weeks to solve a leading problem of the seminar, pupils are accumulating a lot of questions they want to find out.

The author, explaining the theoretical and technical parameters of the lesson-seminar, rightly, from the standpoint of modern realities defines it as “a holistic, pedagogically appropriate system of educational communication of pupils ..., didactic cycle of organization of educational interaction of pupils”, which “contains components (subsystems): preparatory-organizational, preparatory-cognitive, collective-analytical and control-evaluation links” (Kuzmenko, 1997, pp. 7-9). Much of the educational and cognitive activity of pupils, which is carried out at a lesson-seminar, is implemented outside the traditional school environment, which stimulates the communicative activity of schoolchildren. Pupils' independent activity in acquiring information in a seminar is always aimed at dialogue as a collective communication, which the author calls the culmination of this activity. Pedagogical guidance in the seminar-lesson is indirect, which is assessed by the pupils as a sign of trust on the part of the teacher. As a result, pupils often talk about what they would not say in the ordinary answer during a group discussion. As a rule, their speaking activity becomes more meaningful and emotionally colored. By encouraging pupils to engage in intensive educational communication, the lesson-seminar opens up great opportunities for pedagogically appropriate organization of their interaction.

In the next PhD thesis of *Olena Kondratiuk*, conducted under the scientific guidance of prof. V. Lozova, (2009) “Didactic Conditions for Organizing Educational Dialogue for juniors of 6-8 Years”, dialogue from philosophical and methodological points of view is considered as the basis of human existence and identified, as a specific way of realizing the essence of man (Kondratiuk, 2009, p. 3). The psycho-pedagogical studies presented in the dissertation emphasize the advantages of dialogue in comparison with monological methods of teaching, mark its positive impact on the activation of cognitive activity of pupils, speech of pupils, the formation of communication skills and discussion culture and the formation of pupil collective (Kh. Liimets, V. Lozova, O. Matiushkin, O. Chesnokova), on the development of the creative thinking of the pupil (Yu. Babanskyi, V. Davydov, M. Klarin, S. Kurhanov, H. Shchukina and others), his value orientations (V. Andriievaska, O. Dusavytskyi). However, the researcher notes that the didactic conditions that provide the organization of the educational dialogue are insufficiently developed. Ignoring the didactic conditions of organizing the dialogue leads to the replacement of the educational dialogue with the conversation or explanation of the teacher. In both cases, pupils' teaching activity is significantly distorted or impossible at all.

O. Kondratiuk's PhD thesis, firstly presented heuristic for the purpose and content “technique of organizing educational dialogue of juniors as ensuring the interaction between pupils and teachers in the process of comparing the semantic positions of subjects, different equal points of view on the problem”. This technique of application of educational dialogue in teaching of juniors contains several stages of educational activity: preparation of the teacher for dialogue in the lesson, motivation of pupils for participation in educational dialogue, practical realization of dialogue “in the form of discussion for analysis of conditions of educational task and opening of the general way of its solving”; discussing and evaluating search logic and individual achievements; determining the effectiveness of dialogue in the classroom, conducting corrective work. In addition, the groups of skills of conducting educational dialogue by juniors, and methods and ways of formation of these skills are characterized (Kondratiuk, 2009, p. 6).

An important task of O. Kondratiuk's research was to formulate in the juniors a series of skills necessary for dialogue, conditionally combined into two groups: *communicative-moral*, which provided a culture of interaction, behavior in dialogue, a culture of communication, and *communicative-intellectual*, the purpose of which was to ensure the acquisition of new knowledge through collective search, research. Formation of juniors' ability to conduct dialogue during their development of ways of interaction (working in pairs, group, group discussion). Appropriate ways were used to form each skill group, many of which were polyfunctional methods and techniques used to form a series of skills.

In the PhD thesis “Formation of the skills of juniors to ask questions in the process of mastering descriptive knowledge” (2013, supervisor prof. V. Lozova), *Kateryna Lazarijeva* relied on the theoretical position of her scientific supervisor that the key mechanism of any productive educational dialogue is independent and motivated questions of juniors. Therefore, it is necessary to teach pupils constantly and qualified to ask such questions, without which genuine dialogue and any successful learning cannot be built. Based on these provisions of the well-known Kharkiv scientific school, the researcher in her thesis, scientific and methodical works from new positions developed and implemented flexible heuristic technique of mastering by juniors the ability to find and put (for themselves and others) a system of cognitive questions, and on their basis to create independent origins tests.

In constructing the heuristic educational technique as a coherent system, the researcher adhered to the unity of systemic, structural-functional, subject-activity and synergetic approaches – both to the technique as a whole and to its individual components.

The proposed technique by *K. Lazarijeva* makes significant additions and adjustments to the system of heuristic teaching, which has been developed on the basis of the conceptual provisions of V. Andreiev, B. Korotiaiev, A. Khutorskoi and other researchers. It is, first of all, about creating conditions for active creative activity and initiative of juniors through constant dialogic interaction in solving almost all cognitive tasks. Secondly, the proposed technique specifies the main educational goal – self-realization of cognitive and creative qualities of juniors – by solving a number of new educational tasks: improving the dialogue culture of the teacher; teaching juniors the basics of dialogic interaction, the implementation of successive steps (from simple to more complex) children's development of skills to ask themselves and others cognitive questions as the basis of productive teaching dialogue; use these skills to master the basic knowledge for juniors. In the experiment it is descriptive knowledge and corresponding skills of business and artistic description, but the proposed technique is also suitable for the formation of other knowledge and skills – explanatory, prognostic, generalizing.

Heuristic dialogue in higher education, as revealed in the conducted research of the scientific school of prof. M. Lazarev – is a parity and intensive co-creation of the teacher and students, during which the students' activity is initiated in order to identify the unknown and build up a whole group of essential heuristic questions, educational product – in the form of new knowledge, skills, techniques of activity. Such dialogue promotes successful self-realization of the individual, directs it to constant self-improvement of personal qualities and professional skills to think critically, to see problems, to ask to know new, still unknown and on this basis to create own educational product (Lazarev, Lazareva, 2019). The mentioned problem was studied, in particular, by Sumy scientists such as M. Bilotserkovets, N. Hromova, I. Zaitseva, L. Krivshenko, O. Nefedchenko. Two PhD theses were prepared and defended under the guidance of prof. M. Lazarev.

In *Irina Protsenko's* thesis “Heuristic Dialogue in the Formation of Professional-Creative Skills of the Future Teacher of humanities disciplines” (2013) for the first-time didactic model of the use of heuristic dialogue for the formation of professional-creative skills of students of humanities disciplines was theoretically substantiated and experimentally tested. The process of experimental work can be represented as follows. *The motivational component* of the experimental study involved prior preparation for active heuristic dialogue. In the practical lesson, the teacher reveals the importance of dialogue and its specific form – dialogue interaction. *The procedural component* of the experiment covered four main steps of educational activities. These steps are conditioned by the task of actively working and determining their ignorance in the form of questioning activities. The first involved clarifying the content of heuristic activities in accordance with the set tasks of the motivational component. Then the student independently or in interaction with his groupmates selected a series of heuristic questions about the gradual creation of a particular educational product. The third step involved the independent construction of various educational products of pedagogical direction (heuristic conversation, discussion, debate, story, report, pedagogical project, etc.) using a series of constructed heuristic questions. The fourth step is the presentation of the educational product, its discussion at the level of the interactive group and the defense in the academic group. Mastering the theoretical provisions of the relevant topic on a

heuristic basis was based on mastering the leading knowledge of the humanities in a heuristic way, that is by mandatory transformation of the finished information of the teacher or textbook. Adherence to the above conditions became the basis for the transition to the next important, *complex and most comprehensive component* of the didactic model – *the heuristic application of theoretical knowledge and practical skills*. This component is focused on the planning and implementation of the project of creating a student's personally significant educational product as the most important subject indicator of his cognitive and creative activity. *The diagnostic and evaluation component* in the didactic model is a set of consistent pedagogical actions aimed primarily at identifying, analyzing and measuring by clear criteria the quality of mastering professional and creative skills in the process of heuristic dialogue. To achieve objective diagnostics, a whole set of measuring methods based on diagnostic tools was used: self-analysis, self-assessment, peer review, expert analysis and teacher evaluation not only of products, but also the causes of shortcomings and mistakes made by future professionals. *The corrective component* of the model provided a generalization and understanding of the achieved result, finding out the causes of shortcomings and errors, specific actions of performers to improve the quality of their creative products and their final evaluation. Such actions were stimulated by the specifics of heuristic teaching technique, which creates favorable pedagogical conditions not only for motivation and construction of their own product, but also for its further improvement.

The results of the pedagogical experiment showed significant changes in the dynamics of the formation of professional and creative skills of students, which had a positive impact on the quality of their external educational products.

In PhD thesis of *Lina Krivshenko* (2019) “Formation of abilities of application of heuristic educational dialogue in professional training of future primary school teachers” the pedagogical conditions for forming the ability to create and use different types of heuristic dialogue in the holistic system of new teacher's heuristic professional education were first discovered, theoretically and experimentally substantiated. In the work, a complex of diagnostic tools was developed and applied to identify the levels of formation of future primary school teachers' skills in the real application of different types of heuristic educational dialogue. Such diagnostic tools mean a system of consistent pedagogical actions, aimed primarily at detection, analysis and measurement by clear criteria for the levels of formation of skills in the application of heuristic training dialogue by future primary school teachers (general, motivational-value, communicative, managerial-activity, diagnostic (reflexive-evaluative). Diagnostic operations were performed during all stages of realization of pedagogical conditions.

In the process of experimental research for comparative analysis qualitative and quantitative changes in the formation of skills in the application of heuristics educational dialogue by future primary school teachers experimental and control groups were identified as follows: systematically ask cognitive questions; compose a logical series of questions to create a specific educational product (description, story, narrative, article, term paper, qualification work, etc.); interact in interactive group in which students train to ask questions (basic, clarifying, explanatory, generalizing, interpretive, creative, etc.); skills diagnose the quality of interrogative activities and dialogue.

In the research of Sumy scientific school, dedicated to the professional training of future teachers for the development and application of heuristic education and its component – heuristic dialogue – successfully used a whole set of heuristic techniques, in particular, lectures of “direct

action”. In the long-term experimental and practical work, the author's variants of such lecture were applied on the basis of the methods offered by professors B. Korotiaiev and M. Lazariev. As the results confirm, during the lecture of “direct action” students are constantly and creatively involved into innovative cognitive, creative, project, diagnostic activity, master the skills to conduct a heuristic educational dialogue (conversation, discussion, controversy, creation of a series of essential questions and answers), as they become not passive listeners of other's monologue, but active and direct participants together with the teacher for searching and creating new scientific knowledge.

An important element of mastering the dialogue culture was the practice of defending students' own creative projects in seminars and practical classes, created in dialogic interaction with peers and constant access to Internet information resources, which are displayed in audiovisual formats directly in class.

In the experimental work of the scientific school a new form of organization of pedagogical practice of students as a set of design and research studies of masters of pedagogical work and future teachers was tested. The basis of such work is the creation in joint interaction and public defense of prepared professional and creative products – modular developments of a system of lessons in a particular specialty, original scenarios of educational creativity, the results of an experiment to implement heuristic educational techniques. The experience gained in the experimental school showed that teachers are always interested in productive and constant cooperation young people and masters of new inspiration, new strength, new meanings of significance and attractiveness of pedagogical work.

2. Self-realization and cognitive professional creativity of the individual as an integral part of heuristic education

The research revealed that for the first time in the Ukrainian pedagogy the problem of creative self-realization of personality began to be investigated by the scientific school of professor, doctor of pedagogical sciences Valentina Lozova (Kharkiv National Pedagogical University named after H.S. Skovoroda), who together with scientists of the department of pedagogy defined the main goal of educational efforts like *full disclosure of the individual's capabilities and abilities, his creative potential, so that he can be able, in a changing, unpredictable reality, to rely primarily on his own strength, his own mind and will* (Lozova, 2006, pp. 116-118).

The first and the most complete in content work on this problem in Ukrainian pedagogy was PhD thesis of *Liudmyla Levchenko* “Creative self-realization of seniors in research activity of new type's schools” (1999). The thesis was made in the framework of creative cooperation of the department of pedagogy of Kharkiv Pedagogical Institute named after H.S. Skovoroda (Head of the Department prof. V. Lozova) and the department of Pedagogical Creativity of Sumy Pedagogical Institute named after A.S. Makarenka (Head of the Department and scientific supervisor of the thesis – prof. M. Lazariev). For the first time in the thesis the system of heuristic techniques of complex pedagogical support of self-realization efforts of seniors was presented. This system included: a) professional training of the teacher for scientific work; b) teaching seniors the basics of cognitive and creative self-realization in the process of research activity; c) creation and application of organizational, pedagogical and psychological mechanisms that ensure the clear activity of the teacher-researcher and senior-researcher; d) organization of creative interaction of all members of research; e) application of a set of criteria and indicators of pedagogical diagnostics to measure and evaluate the dynamics of the self-realization of seniors' creative abilities.

This PhD thesis deals with productive and perspective development of conceptual, substantive and operational bases of heuristic technique of pedagogical influence on formation of creative self-realization of seniors. If in management aspect the leading condition for the success of heuristic technique was the recognition and support of the city department of education and the board of directors of institutions of new type of research work of capable pupils as a necessary component of their secondary education, then the leading components of the heuristic technique of creative self-realization became: a) training of pupils-researchers of self-activity skills in choosing the topic of research, setting and ways of achieving its purpose and tasks, protection of the obtained results; b) creation of conditions for forming skills of long-term immersion in the creative-research process, with the emphasis on reflexive activity; c) competent heuristic interaction of the teacher and pupil-researchers at all the levels: humanistic communication, affirmation of empathic and at the same time constructive relations on the basis of heuristic dialogue.

Developed and applied heuristic technique as a part of the pedagogical conditions and mechanisms of pedagogical support of seniors in experimental work has been tested experimentally for two academic years and has shown significant positive results.

The study of candidate of pedagogical sciences L. Levchenko, though was focused only on one area of creative self-realization – research activities of seniors – gave the opportunity to make general conclusions about the effectiveness of complex application of heuristic techniques for the formation of dialogical interaction of the teacher and pupils based on the mastering of real heuristic dialogue; the technique of determining the purpose and objectives of the research; technique of independent in-depth scientific study and transformation of a small volume of the research subject, and so on. The analysis of the complex heuristic techniques applied by us revealed both the positive aspects of its conceptual, substantive and operational characteristics, as well as objective disadvantages and unused opportunities, which the author perceived positively and explained only by the beginning at that time (late 90-ies) development of theoretical and technical foundations of heuristic education. In particular, it was found that in the conducted research deep development of the technique of dialogic interaction between the teacher and seniors on the basis of heuristic dialogue was not carried out, the peculiarities of the organization of independent activity with reliance on modern research of famous scientists of this phenomenon in the conditions of cognitive-creative activity are not revealed (V. Lozova, B. Korotiaiev, P. Pidkasystyi, S. Kulnevych, etc.). Identified problems can be attributed to perspective directions for further research of techniques of heuristic education.

Further development of concepts and techniques of creative self-realization of the personality was carried out in the doctoral dissertation of the representative of prof. V. Lozova's scientific school *Liudmyla Rybalko* "Acmeological principles of professional-pedagogical self-realization of the future teacher" (2008). The author first discovered the contradictions at the level of defining the content and techniques of preparation of future teachers: "between a holistic view of the nature of self, acme, peculiarities of pedagogical activity and insufficient reproduction of them in the content of higher pedagogical education; between the need for purposeful pedagogical self-improvement of the internal resources and capabilities of the future teacher and the lack of implementation of acmeological techniques, in the process of mastering of which "I"-conception is formed". The author rightly points out that in previous studies little attention was paid to the professional-pedagogical self-realization of the future teacher, the concepts and techniques of its achievement (Rybalko, 2009).

Our professional interest aroused the stated purpose of the research: “to theoretically substantiate the scientific and methodological system of professional and pedagogical self-realization ... to develop and introduce technique to ensure the future teacher's readiness for professional and pedagogical self-realization on acmeological grounds”. Attention was drawn to the research tasks of the dissertation, especially those aimed at: “development and experimental verification of the technique of ensuring future teacher's readiness for professional-pedagogical self-realization”, “clarification of the criterion base for monitoring the quality of future teacher's preparation for to professional and pedagogical self-realization” (Rybalko, 2009).

L. Rybalko agrees with the researchers of the process of self-realization of personality as a strategy of the educational process (A. Maslou, K. Rodzhers, V. Sukhomlynskyi, V. Bepalko, B. Korotiaiev, A. Khutorskoi, etc.). It is known that these researchers consider the process of self-realization as completely heuristic, creative, which relies on a complex of composite techniques, that is, a peculiar metatechnique of heuristic character both in content and forms at all stages of cognitively-creative and professionally-creative self-growth – from self-determination of personal value orientations and needs, goals and objectives, practical implementation of prognostic, constructive actions and operations to create a significant educational product to monitoring (diagnostics and evaluation), improvement of activity and choice of further ways of self-realization efforts.

For the first time, the research proves the feasibility of developing personal self-realization on the basis of general acmeological provisions: “the goal of self-realization of the person is to achieve acme, which occurs in the process of development and self-development”, “the highest degree of self-realization is characterized by professionalism, skill, readiness for performance forms; self-realization of the person should be productive, because it is from this point of view that the person opens and realizes the creative potential in the activity as much as possible” (Rybalko, 2009). Acme in the research is considered as a phenomenon of human nature, the pinnacle of maturity, multidimensional characterization of the state of personality, the process of achieving the highest performance in personal and social development, professional activity, creativity.

The scientific and methodological system developed by the author was provided with variational technique, which included: a) monitoring the quality of future teacher's training in particular directions, b) introducing in experimental groups certain ways of stimulating professional and pedagogical self-realization; c) organization of self-disclosure of the inner potential of the future teacher with the use of acmeological training; d) formation of an individual style of professional and pedagogical self-realization of the future teacher.

Particular attention was paid to new educational techniques, such as acmeograms, which gave a good idea of the start-up capability and potential of a high-skill person. Acmeogram includes analysis of types of professional-pedagogical activity, its purpose, motives, means, structure, functions, algorithms of actions and operations, description of acmeological invariants in the subjective characteristics of professional activity, in its qualities, providing for progressive development, professional self-improvement of the specialist, his promotion to high levels of professionalism (according to A.O. Derkach, A.K. Markova, S.S. Palchevskyi).

The acmeogram is always individual, drawn up for a specific specialist and aimed at his individual development of pedagogical skills, taking into account the conditions and acmeological (objective and subjective) factors. In a typical scheme of acmeogram there are sections related to the level of general (substructure of professional qualification, general acmeological invariants of pedagogical skill), special (substructure of orientation of personality, specific acmeological invariants

of pedagogical mastery), single (substructure of abilities, characteristic features, moral qualities). The acmeogram identifies and characterizes the criteria and indicators that fully reflect the structural-functional, substantive components of the process of teacher's pedagogical mastery development in the system of postgraduate education. According to these criteria and indicators we can objectively observe acmedynamics in the professional, personal and motivational-reflexive fields.

In *Natalia Hromova's* PhD thesis entitled "Creative self-realization of seniors in the heuristic teaching of humanities cycle subjects" (2010) (supervisor prof. M. Lazariiev) were found out the creative qualities of seniors (in-depth motivation for independent creativity, creative interaction of subjects of learning, possession of mechanisms of creative activity, diagnostic skills for measuring and evaluation of educational products in, cognitive and creative independence). Their constant development in practice is at high and sufficient levels and is a testament to the success of creative self-realization.

In the research of M. Lazariiev's scientific school (N. Hromova, M. Bilotserkovets, O. Krivonos, T. Plokhuta, O. Nefedchenko, etc.) was found that the creative self-realization of seniors and students in the process of teaching consists in the deployment and development of the above mentioned cognitive-creative qualities "as important essential forces, aimed primarily at creating the subjective results of self-realization – personally meaningful products" (Hromova, 2010, p. 14). In generalized form, self-realization is defined as "a conscious, purposeful process of deployment and growth of essential human forces, in particular a child, adolescent, young man – his ideas, creative abilities, skills, needs, motives, life values (Lazariiev, 2013). In the specified scientific school on creation and application of innovative, in particular heuristic, techniques of department of pedagogical creativity have found out that traditional models of educational activity cannot provide successful self-realization of cognitive and creative qualities of the person as the purpose of modern education. The unpreparedness of the majority of students and seniors for intensive and productive creative activity is proved. Heuristic education and its techniques, which create didactic factors and conditions for significant improvement of independent cognitive and creative work of all members of educational process, are aimed at preparation for such activity and its successful implementation.

An unconditional achievement of this scientific school was the creation and active operation of the Department of Pedagogical Creativity at Sumy Pedagogical University. The head and scientists of this department created methodological, theoretical and technical bases of training of the future teacher of pedagogical creativity, and later and integral system of heuristic training of students and schoolchildren, having developed and introduced in educational practice a dozen original manuals, monographs, methodical recommendations.

The scientists of the department have established that the heritage of world and national pedagogy, the practice of thousands of teachers and teachers allow to conclude that the priority of creative work of all subjects of education is necessary relative to reproductive. Research, heuristic, creative activity always prevails over repeated mechanical repetition of material, learning of already known rules and cliches (without attempting to creatively apply the acquired knowledge). This pedagogical pattern at the theoretical and practical levels was successfully implemented by K. Ushynskiy, A. Makarenko, V. Sukhomlynskiy. Their followers, researchers of creativity, as a specific type of activity, draw attention to the fact that such activity is characterized not only by novelty but also by progressiveness, that is, by creating, generating new things for the positive development of man and society, rather than being hostile and destructive to them (S. Holdentrikht, M. Nikandrov, Ya. Ponomarov).

On the basis of studying and generalizing many works of the mentioned scientific school, we offer ourselves and readers several aphoristic provisions that reflect some of the visible and invisible qualities of creativity and its practical embodiment of heuristic education.

1) Creativity is either the guiding or meaningful basis of heuristic education as an innovative phenomenon of the transformation of the thinking person into the creator of a new, more perfect world.

2) The primary source of the teacher's creativity is the natural desire of the person to assert himself and to realize himself, that is, to develop, increase, form and apply in his life the most important human capital – knowledge, abilities and skills necessary for a voluntarily chosen profession. Creativity is not so much the creation of something new and progressive by the man's head and hands, but the creation of his personality (but not only in the process of creating by the individual spiritual and material objects around him).

3) Three main driving forces of creativity – *creative motives, creative abilities and skills* to create new and *methods (ways)* of creative activity. Creativity is the surest and most economical way to save yourself from despair and hopelessness, and a tool for endless self-growth. There is no analogy to the lifeline of creativity, as there is no boundary and boundaries of the flourishing of creative forces of a normal person.

4) Creativity should be timely and persistently taught (in groups and alone). Only under the heavy burden of an urgent need or an unbearable desire to create something hellishly necessary for you is born the freedom and energy of creative activity, which in turn gives birth to a free person, which will be able to self-realize, grow and self-improve in a freely chosen field. Only the necessary critical mass of true creative self-realizers creates a wealthy, just and spiritually rich social order.

5) General creative professional qualities of the future teacher, which are inevitably formed in heuristic teaching and upbringing: sensitivity to the problem, flexibility, originality, mobility of thinking, developed imagination and ability to predict and construct new ideas and objects, developed intuition as an alloy of (according to V. Sukhomlynskyi) knowledge and experience, unity of convergent and divergent thinking, ability to improvise, increased working capacity, professional honesty; special professional-creative qualities: professionally motivated creative activity, communicative-creative, research, didactic, rhetorical, reflexive skills and abilities.

6) The main creative methods in pedagogy and education, according to the classification of M. Lazarev, are research (formative and diagnostic), creative-monological (description, explanation, story, lecture, report) and creative-dialogical (heuristic conversation, discussion, debate, dispute).

The above and other postulates (not written off, not borrowed, but melted down, rethought from thousands of sources and 56 years of pedagogical experience of the head of the scientific school) of pedagogical creativity are developed and explained in the published manual "Pedagogical Creativity" (1993, 1995, 2016), 10 monographs and, in more than 100 scientific articles. Under the guidance of prof. Lazarev 20 PhD theses devoted to various problems of creativity and heuristic education were defended. Unfortunately, in 2017 the department of pedagogical creativity was disbanded and the problem of theoretical study of creativity, as one of the main components of renewed (heuristic) education, has not been fully explored.

Conclusions.

Heuristic education with its main components is gradually but surely developed and improved by Ukrainian scientists and educators, practically used by pedagogues-innovators in the educational process, adapting to the modern world, to each generation of adolescents. It is heuristic education with its flexible innovative ideas and techniques that the renewed Ukrainian higher pedagogical school needs to train a new type of teacher – researcher, humanistically oriented, independent, creative personality, able to inspire young people to constant self-improvement and self-realization. It has been found out that in the context of complex contradictions of the information society, the crisis of human values, there is an urgent need for qualified professional training of future teachers for the development and application of innovative pedagogical techniques of innovative education, in particular, deep theoretical and practical master of educational technique – the basics of any effective educational technique.

Research analysis revealed the effectiveness of the development, continuous modernization and use of heuristic and acmeological techniques for the development, self-realization and self-growth of the future and acting teacher, a real transition from a monological educational system to a heuristic dialogue, which develops motivation, independence, initiative, creative, scientific competences at all stages of the educational process.

It has been ascertained that the concept of colossal opportunities for own creative and professional self-realization (H. Skovoroda, A. Maslou, K. Rodzhers, V. Sukhomlynskyi, M. Amosov, P. Kopnin, etc.) is enriched with new ideas and techniques, in particular acmeology, where complex acmeological technique of assessment, correction, modeling and development of professional acme of the subject of professional activity as a conscious movement of the future teacher to the professional standard, which allows on the basis of self-knowledge to determine the source, driving force of self-development, self-satisfaction and self-affirmation.

References

1. Hromova, N.V. (2010). *Tvorcha samorealizatsiia starshoklasnykiv v evrystychnomu navchanni predmetiv humanitarnoho tsyklu*. Extended abstract of candidate's thesis. Kharkiv: KhNPU imeni H.S. Skovorody [in Ukrainian].
2. Kondratiuk O.M. (2009). *Didactic Conditions for Organizing Educational Dialogue for juniors of 6-8 Years*. Extended abstract of candidate's thesis. Kharkiv [in Ukrainian].
3. Kuzmenko O.V. (1997). *Organization of educational communication of pupils at a lesson-seminar*. Extended abstract of candidate's thesis. Kharkiv [in Ukrainian].
4. Lazarev M.O., (2013). Creative self-realization of the personality of a teacher, student, pupil in human-centered heuristic education. *Profesiino–tvorcha samorealizatsiia maibutnoho pedahoha v innovatsiinii osviti*. M.O. Lazarev (Ed.). Sumy. 69-111 [in Ukrainian].
5. Lazarev M., Lazareva, O. (2019). Dialogic education – an alternative of monologic, authoritarian pedagogy in an information society environment. *Osvita dlia XXI stolittia: vyklyky, problemy, perspektyvy: materialy I Mizhnarodnoi konferentsii* (pp.152-157). - Sumy: SumDPU im. A.S. Makarenka [in Ukrainian].
6. Lozova, V.I. (Ed.). (2006). Lectures on pedagogy of high school. *Guide book*. Kharkiv [in Ukrainian].
7. Rybalko, L.S. (2009). Akmeolohichni zasady profesiino-pedahohichnoi samorealizatsii maibutnoho vchytelia. *Extended abstract of doctor's thesis*. Kharkiv: KhNPU imeni H.S. Skovorody [in Ukrainian].

Nataliia Prykaziuk

Doctor of Economics, Associate Professor Taras Shevchenko National University of Kyiv, Kyiv, Ukraine

orcid.org/0000-0002-7813-8590

Vasyl Erastov

Ph.D. in Economics

Taras Shevchenko National University of Kyiv, Kyiv, Ukraine

orcid.org/0000-0001-5230-0273

Oksana Lobova

Ph.D. in Economics

Taras Shevchenko National University of Kyiv, Kyiv, Ukraine

orcid.org/0000-0002-6585-5152

PERSPECTIVES OF IMAGE RECOGNITION UTILIZATION IN INSURANCE

Abstract. *Development of computer vision, the Internet of Things (IoT) and artificial intelligence will bring many changes and challenges brought by new technologies such as image recognition to different industries. Image recognition is a modern trend of many industries, that is used for different implications. Areas of utilizing automated image recognition are customer identification, underwriting process, claim analysis and processing, disaster monitoring and document digitization. Also, it could bring customer service improvement, fraud detection and avoidance and personalization of services. Insurance industry will be one of the most fast-growing industry utilizing image recognition. The areas of application mentioned here are far from a complete list. With further improvement of image recognition models and data collection, image data will add more value to the insurance industry. At the current stage, there are a few factors need to be considered before using automated image recognition techniques for real applications. Further developments are needed to improve model accuracy so that models are intelligent enough to improve analysis and decision making.*

Introduction.

The insurance industry faces various issues: volatility in the financial markets; the markets' maturity; insufficient capitalization; increasing risks; low interest rates; changing regulatory requirements. In addition to economic problems, insurers are also affected by other changes that necessitate them adjusting their activity. Faced with a lot of challenges from technologically sophisticated clients and demanding financial climate, insurers need to work faster, more efficiently and rationally.

Presently in the world, digitization puts a great deal of pressure on traditional insurance companies as customers become more aware of insurance, and therefore expect receiving individual products and services, as well as self-service opportunities in combination with the latest technologies. Customers expect insurance companies to be using web and mobile applications as channels for their continued engagement throughout the life of the insurance contract. In addition, new players, such as startups and data giants, are entering the traditional insurance market and increasing competitive pressure on all players. Insurance companies need to act both promptly and carefully to compete effectively with companies that capture customer experience and value offers in the digital space better.

As technological capabilities develop and a radical change in consumer expectations take place, the company-oriented economy gradually transforms into an individual-oriented economy. Individually oriented economy features the product differentiation and individual market segmentation aimed at providing consumer with value. Insurers are trying to keep up with the transition to an individually-oriented economy, where the following four elements of digital transformation are crucial: being flexible, integrated, adaptable and responsive to change.

Image recognition techniques are becoming a part of many areas of nowadays life, such as facial, image and optical character recognition. Although models, that are used for image recognition models are very complex, the overall process from image containing data to result prediction is no different from that of traditional statistical and mathematical modeling. Image recognition models utilize traditional models to approximate the complex relationship between input and output data that is unlikely to be represented by a single simple function. Most methods of regularization and normalization that are used in image recognition are also used in traditional models and approaches. All the tools available for image recognition techniques developing make the use of such models possible for insurance actuaries with a common background in statistics.

Automated image recognition may be applied to many areas of the insurance industry. It can be utilized to improve client service, for example using facial recognition to verify identity, faster underwriting and claim processing. With satellite images, precise agricultural insurance pricing and risk assessment can be achieved with weather and landscape information for any area, even a few kilometers. Home insurance pricing can be improved as well using traditionally difficult-to-capture images of the insured property such as the roof. Extreme risk events such as hurricanes, tornadoes, floods and wildfires can be monitored and the impact on insurance claims updated in real time with the aid of automated image recognition. Medical images can provide richer information for health insurance underwriting and pricing. Optical character recognition can help digitize documents and facilitate information saving, searching and sharing.

There is no doubt about benefits of image recognition techniques involving in the long run. Before applying them in practice a few factors need to be considered. The amount of available data needs to be big, and the cost of data collection needs to be reasonable. The accuracy level of the model should be acceptably high, and the adverse impact of a wrong prediction should be manageable. The improvement of decision making needs to have sufficient financial benefits to offset the large investment in the techniques. As with the adoption of any new technology, it is a cost-benefit analysis to consider the investment of resources versus the gain from the application[1].

Technical challenges also exist for a successful application of automated image recognition. Existing models are usually trained to identify the objects in images, but for insurance applications, the behavior of an object is more useful information. For example, a driver using a cell phone while driving. This often leads to more customized model training using relevant image data. Data collection and model training may take a long time and require many resources. The current accuracy level of most advanced models is up to 90%. A small error could lead to potential customer complaints and reputational risks. Cyber risk may also increase when automated image recognition techniques are utilized.

For example, if facial recognition is used to confirm identification, the program may be hacked or overridden so that it accepts illegal requests and allows illegal access to private and confidential data.

Further developments are needed to improve model accuracy so the models are intelligent enough to improve users' analysis and help in decision making process. At the same time, image recognition technics can provide many opportunities for insurance actuaries. Utilizing both the industry knowledge and the technical skills, insurance actuaries can help link image recognition with risk assessment and decision-making process in a meaningful way. They can help design image recognition model structures that can solve complex insurance-related issues and help to validate image recognition systems conclusions using existing models based on different data sources.

1. Main part

Development of computer vision, the Internet of Things (IoT) and artificial intelligence will bring many changes and challenges brought by new technologies such as image recognition to different industries. Image recognition is the process of using a machine or computer to detect and identify an object, a feature or other useful information from a graphical data in a form of image or a sequence of images such as a video. A common example of image recognition is optical character recognition (OCR). Without human reading and recording, a scanner can convert an image of texts to a text file by identifying the standard characters in the image. OCR may also be applied to recognize a license plate in a photo. It can be used for automatic red-light cameras, speed cameras or parking meters. Facial recognition, automatic inspection, cancer prognosis, species identification and automated driving are other examples of image recognition concepts.

Flexibility involves development of transparent and automated processes when providing insurance services. Integrity features the interconnection of the individual / company and digital / existing technologies. Adaptability is related to the study of the policyholder's individuality. The speed of decision making depends on the time spent on data processing and making final decisions in the insurance companies' activities and the process of interaction with insurers.

At the same time, insurance companies need to make full use of the following number of opportunities in order to be able to digitally transform a business: being overly aware, which implies an increasing ability to recognize, control and identify information; make informed decisions - analyze/disseminate information and ideas in real time, make recommendations based on customization and forecast; achieve the speedy accomplishment of the assigned tasks firstly with automation; interact/cooperate at all stages of the insurance agreement; prevent losses rather than consider claims, which involves the use of a wide range of preventive actions to reduce risks [1].

Image recognition is expected to affect the overall insurance industry. It can strictly improve interactions with clients by providing higher efficiency. Image data is another dimension of data that can be collected, analyzed and utilized to improve decision making process. The insurance industry is gradually applying image recognition technology. Areas of utilizing automated image recognition are customer identification, underwriting process, claim analysis and processing, disaster monitoring and document digitization. The changes improve competitive advantages of the insurance business and have a profound impact on customer behaviors, risk assessment and information flows. Facial recognition will be more convenient for customers to apply for insurance coverage or claim insurance benefits. Images of an insured property can be used for underwriting process. Using drones and multicopters to take photos of roofs can improve home insurance underwriting through image recognition and analysis. Images of car drivers may also be utilized to detect unsafe driving patterns, which can help assessing risks and improving driving safety.

Images of an insurance accident or a disaster can help insurers to identify issues, allocate resources and estimate losses.

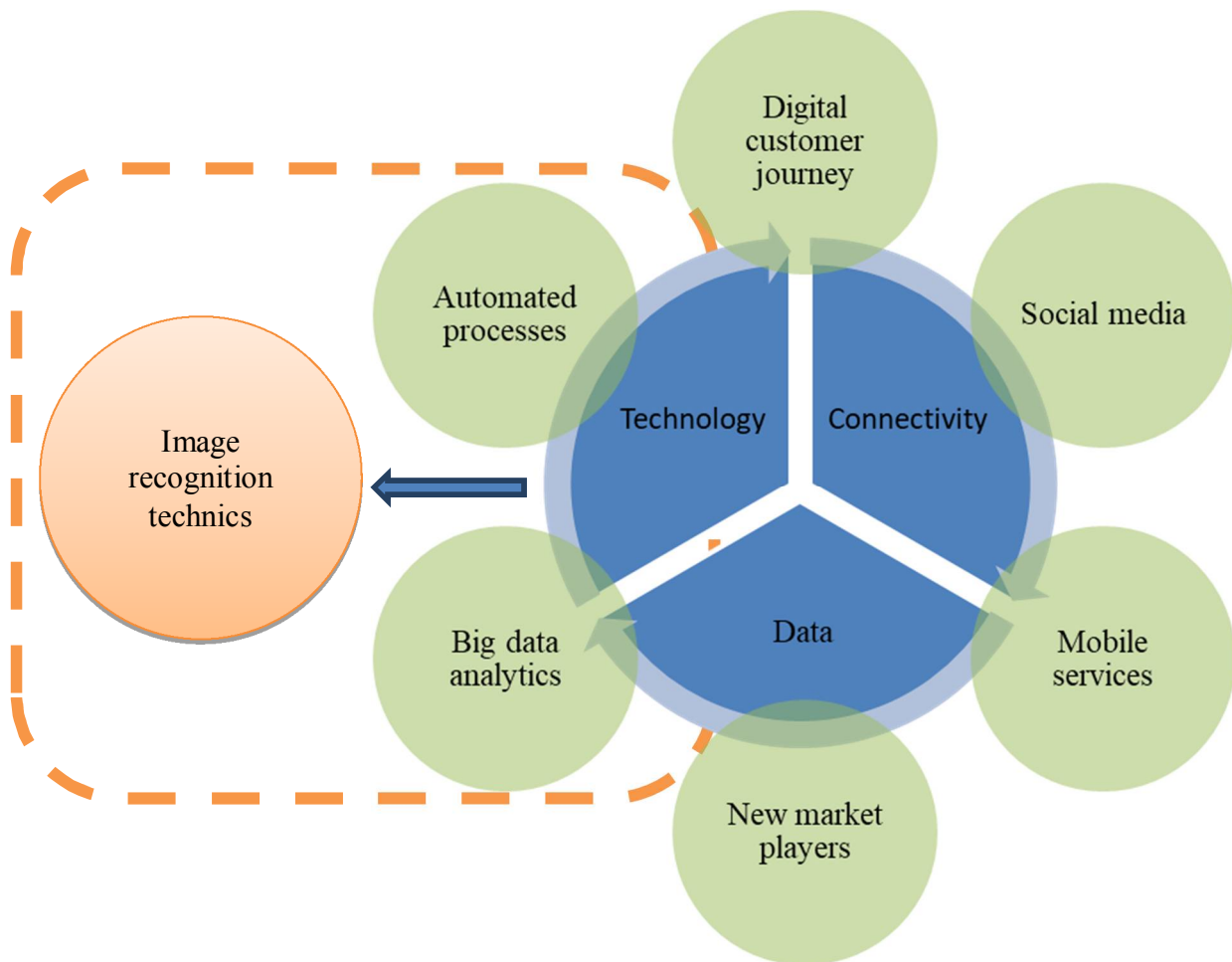

Fig. 1. Place of IRT in digital insurance industry [2]

A typical image recognition application is complicated but the process is similar to traditional statistical analysis. Images are represented as data and then processed. Common processing includes data compression, noise reduction and contrast enhancement to provide better model input. Features such as lines, intersections, borders, shapes and characters may be extracted from images, or they can be learned automatically from the raw data by deep learning models such as a convolutional neural network. Models are trained to link images with significant outcomes such as object types and behavior patterns. Models are then validated to ensure that they are powerful enough to predict correct outcome. If a model generates satisfactory insights, it will then be utilized for real business application.

Usage of full resolution images is too resource consuming, so many models utilize some encoding and decoding features. The compressed image can be used as a source data for image recognition ANN or could be reconstruct with some grade of difference between source and output. The simplified model of encoder for QVGA image will be [6]:

, as an input;
 , as an encoder with n features

Where

x_i is the value of x -th image pixel

c_n is the selected feature of image compression

W is a weight vector matrix

b is a column vector

Encoded and decoded image are not equal. The main idea of such image transforming is to reduce load for analytical soft and hardware, but some losses can occur. Minimizing the difference between input and output is a key factor of ANN training.

Automated image recognition can be used by the insurance industry in a different manner. The first concept is that images can provide additional data that traditional sources cannot. For example, if we see a photo of a driver using a cell phone while driving, it means that the driver is more likely have a high-risk profile. The second concept is that automated image recognition can quicken tasks and reduce service time. But why should insurer rely on an automated system or human judgment will be more accurate. From a resource perspective, there may be overwhelming number of images for efficiently and timely by human processing. From a cost perspective, it may be cheaper to use models rather than humans to retrieve information from images.

Image recognition is already prevalent in many industries, including insurance industry. Authentication, automatic tags suggestion, image search, and image matching are widely utilized in social media services, e-shopping and mobile services. Existing applications are related to client service and security improvements. For example, facial recognition is one of the most popular applications of image recognition in the banking. Many banking institutions allows users use automatic facial recognition on their cellphones to log in to mobile banking services. Other applications of image recognition in banking industry include the following:

Video surveillance, to improve the security of bank facilities, image recognition programs are integrated to real-time camera streaming systems to prevent unauthorized access and identify suspects in case of an event. This can save hours of human work for manual searching with traditional surveillance footage. Banks can also analyze videos of different branches to rearrange the client's path from entrance to exit. Automatic image recognition can be useful in collecting of important insights on wait time, the customer service process, and where the customer service can or should be improved.

Facial recognition can reduce the fraudulent use of data and banking services. As an example, facial recognition may be required for online banking login in or check out, authentication at ATMs and employee system log-in. It may also prevent clients from registering for services using different identities. Real-time alerts enabled by automatic image recognition provide instant knowledge of risks and allow to minimize loss.

Facial biometrics can be used as a part of personalization by identifying important clients and provide personalized services to improve their satisfaction.

Verification of signatures or other handwriting by automatically assessing the similarity of a signature on different records, a customer's identity can be verified to approve banking transactions.

Based on potential clients' image data in open social networks, marketing and sales efforts can be tailored for better success. Clients may be classified into different types with corresponding marketing strategy and product solutions.

Overall neural network model can still be represented as a function of some X input, which won't be linear, but will involve linear layers' functions ($WX+b$) and some additional nonlinear activation functions [6]:

$$Y = f(X; W_1, b_1, W_2, b_2, \dots, W_j, b_j)$$

Where:

j is the output layer number, and $j - 1$ is a quantity of hidden layers of ANN

Like other fields, the insurance industry can benefit from automated image recognition in many areas. Some applications can leverage mature techniques, whereas others need customization and improvement.

Image recognition can be used to improve customer services. This is similar to what is happening in the banking industry. For example, if facial recognition can be used to verify identity, it is easier for existing customers to review their policy information and get services. Facial recognition is also more secure than user names and passwords. For future customers, applying for insurance can be much easier with image recognition. Customers can take a photo of their required documents and e-mail them to the insurance company. The image recognition engine translates the images into the required information, and the application may be approved in just a few seconds if everything goes well. The same advantage can apply to the claim process. For instance, an auto insurance claim may be made simply by taking a photo of the accident scene; a home insurance claim by submitting a picture of the damage caused by flood, fire and so on; and a health insurance claim by taking a photo of the patient record. The list goes on. If done properly with a high level of accuracy, these applications will not only improve customer satisfaction, they will reduce claim adjustment costs and potentially provide richer information than was available before. Images of accident scenes deliver more information than that provided by adjusters and may also help unify the practices in claim adjustment.

Agricultural insurance pricing and risk analysis can benefit from image recognition techniques. With satellite images, these techniques can provide information about the size and type of irrigation, landscape changes and weather conditions for areas as small as several kilometers. This enables more customized and precise prediction of the average crop yield, its volatility and worst-case scenarios. Such predictions are unlikely to be achieved without image data, meaning available data for pricing and risk assessment are often at a much higher level.

Property insurance is another area that may benefit from image recognition. Together with the development of the Internet of Things, more images that can provide information on an insured property will be available. For example, pictures of a house roof can be taken by drones to better understand the condition of the house and determine risk. Such images can be used not only in the underwriting process but also for loss control, which benefits both clients and the insurance company. will be available. For example, pictures of a house roof can be taken by drones to better understand the condition of the house and determine risk. Such images can be used not only in the underwriting process but also for loss control, which benefits both clients and the insurance company.

For extreme risk events such as tornadoes, hurricanes and wildfires, image recognition techniques can help with real-time risk monitoring and risk management. If a satellite image of a tornado path or flood area is available, image recognition models can help detect the damaged areas as well as the degree of damage. Together with policy information, an automated system can predict the claim count and dollar amount, allowing the company to be better prepared to manage claim

risk. A well-trained image recognition model can identify the tornado path, determine whether the insured homes are damaged and, if so, how severe that damage is. This kind of estimation can be updated in real time with the latest images if a risk event continues to develop [4].

Health insurance is another area where image recognition can provide more insight regarding the risk of individual customers. Physicians can use image recognition for diagnosis and prognosis. In addition to linking doctors' opinions to insurance pricing, given enough image data and claim experience, medical images such as computed tomography (CT) images of cancer patients may be used directly as pricing factors to help underwriting and derive risk loading and insurance premium rate. Such images are used to determine whether a patient has lung cancer, how severe it is and how it affects the insurance price. It is definitely not the only pricing factor and needs to be used together with physicians' opinions. However, images may provide richer information than diagnosis results and can help improve the accuracy of the pricing model.

Image recognition techniques can also transform hard copy into digital files—often called optical character recognition. This can be very useful for companies that have underwritten business for decades or acquired long-dated business through mergers and acquisitions. Files are scanned, and contents are recognized and can be searched in a computer.

The areas of application mentioned here are far from a complete list. With further improvement of image recognition models and data collection, image data will add more value to the insurance industry. At the current stage, a few factors need to be considered before using automated image recognition techniques for real applications: Sufficient amount of data is necessary to train the model. If the data volume is small, relying on human intelligence may be more efficient and economical. Image recognition models should improve decision making process. If the contribution is marginal, there is little financial incentive to use this new technique.

Automated image recognition systems should be accurate. There are many adverse effects of wrong prediction. If a model is not well trained for specific insurance problems, low accuracy and adverse effects could kill the application.

There should be permitted by customers, regulators and/or the public to utilize image data. Like the adoption of any new technology, companies need to perform a cost-benefit analysis to examine the investment of resources necessary for and the potential gain and loss from the application. However, this is more a question of when image recognition can be applied to a specific business issue rather than if the technology should be adopted for the industry as a whole.

Although the accuracy of image recognition techniques is continually improving, errors are unavoidable. For example, different family members may be recognized as the same person and log in to the same cell phone using facial recognition. This may be a problem if the primary user's insurance account information is protected by facial recognition.

Other security measures such as fingerprints may be used with facial recognition to improve security, especially when material policy changes and transactions are involved.

Applying image recognition to the insurance industry still faces many challenges. Existing models are usually trained to identify the objects in an image. However, for insurance applications, more useful information may be the behavior of the object. For example, is a driver using a cell phone while driving? Is a house's roof in good enough condition to withstand hurricanes? How many insured houses were hit by a tornado? This often leads to more customized model training using relevant image data. Data collection and model training may take a long time and require many resources. [3]

Another key obstacle of applying image recognition techniques to the insurance industry is the accuracy level. Currently, the highest accuracy rates for popular image recognition competitions, such as the ImageNet Large Scale Visual Recognition Challenge, are usually between 70% and 90%. This is unlikely to be good enough for many insurance applications. Even with the most advanced image recognition models, false conclusions are not unusual. A common example is that an upside-down vehicle may be recognized as a plane.

Using an image captioning model that was trained with the Microsoft Common Objects in Context (COCO) image database, the image is interpreted as “a large airplane sitting on the side of a road.” The trained model relies on the shape of the body of the plane (cockpit and fuselage) but omits other parts such as the tail. The model is also unable to differentiate between a wing and an open door. This can be rectified by feeding more training examples of flipped cars into the model to help it learn the nuances of the shapes. The example also demonstrates the current status of image recognition: a universal model does not exist to meet all the requirements. Fine-tuning the model with specific training data is necessary to improve accuracy for more insurance applications.

The risk of using automated image recognition is not negligible. A small error can lead to customer complaints and financial losses. For example, if a cancer patient applies for life or health insurance and a CT image of the tumor is used to assess the risk and determine appropriate pricing, an error in the model estimation could lead to unnecessarily higher rates or rejection of the application. On the other hand, it could underestimate the risk and specify insufficient rates. If the accuracy rate is not high enough, it could also increase the underwriting risk for the insurance company. At this time, a hybrid approach combining automated image recognition and human intervention is more practical. Human intelligence is still needed to guide and validate automation, especially for high-risk cases and those where the model is less certain.

Cyber risk may also increase when automated image recognition techniques are used. If facial recognition is used to confirm identity, the program may be hacked so that it accepts illegal requests and allows illegal access to private data. Even if the program is safe, carefully designed adversarial examples may be able to fool the recognition model. By adding some noise to the original image, the prediction changes from a dangerous driver to a safe driver. However, the difference is negligible to human eyes. Models with low accuracy or close probability estimates for different classes are extremely vulnerable to adversarial examples.

When using images for fast claim processing, images may be faked or altered to submit false claims. Predictive models must be able to detect these frauds and enhance the defense against adversarial examples.

Regulatory and reputational risk may also occur with the application of image recognition. Image data may not be considered private and thus may be judged inappropriate for determining insurance rate and claim. If an insurance company does not fully explain its methods to customers, regulators and the public, using nonpublic image data could cause reputational incidents. Even if the data are usable, the way they are used to assess risks and determine insurance premium may be questioned. Clients may want to know exactly how the algorithm determines the risk loading for insurance products. Goodman and Flaxman (2016) studied the impact of the European Union’s (EU’s) general data protection regulation that restricts automated individual decision making that “significantly affect” users. Insurers that want to use image recognition technology need to be prepared for explanation and communication.

Conclusions.

Insurance companies are adapting new business models and leveraging digital capabilities to provide advanced consumer opportunities. Recently, the insurance industry has begun a radical transformation, driven by a series of digital innovations that have been widespread in recent years. For example, “Bain&Company” and Google have identified seven key technologies [8] that have already begun disestablishing the traditional understanding of the insurance industry’s essence with continuously accelerating impact in the next three to five years. Those technologies include the following: infrastructure and performance (modern IT architecture); online sales technologies; advanced analytics; machine learning; internet of things; distributed ledger technology; virtual reality. The practical importance is a common feature of all these technologies. They are already used to varying degrees today and will be widely available in three to five years.

Further developments are needed to improve model accuracy so that models are intelligent enough to improve analysis and decision making. At the same time, such models provide many opportunities for actuaries. Given their strong statistical background, actuaries have already mastered the fundamentals of image recognition models, so they can quickly grasp the new techniques with proper training. Equipped with both the industry knowledge and the technical skills, actuaries can participate in linking image recognition to risk assessment and decision making in a meaningful way. They can also help to design image recognition model structures that can solve more complicated insurance-related issues and validate image recognition conclusions with their existing models based on alternative data sources. This will help to limit the risks of image recognition.

References

1. R.Pikus, N.Prykaziuk, M.Balytska. (2018). Financial sustainability management of the insurance company: case of Ukraine. *Investment Management and Financial Innovations*, 15, 219-228
2. Digital Transformation for the Insurance Industry Unleash Your Next-Generation Financial Services Business (2017). URL:<https://www.cisco.com>
3. Insurance Companies: Staying Competitive in the Digital Age What needs to be done to become a Digital Insurer? (2018). URL:<https://www.otto-company.com>
4. V. Erastov. Main Trends in Insurance Market of Foreign Countries That Have Positive Impact on Internet Insurance. *Accounting and Finance*, vol 72, 2016, pp. 110-118.
5. Townsend's D. Artificial Intelligence: The Next Step in Corporate Governance. URL: <https://blogs.cfainstitute.org>
6. Bahrammirzaee A. Comparative survey of artificial intelligence applications in finance: artificial neural networks, expert systems and hybrid intelligent systems. *Neural Computing and Applications*. 2010. Vol. 19. Issue 8. Nov. P. 1165–1195.
7. Kitchens F. Financial implications of artificial Neural Networks in automobile insurance underwriting/ F. Kitchens//*International Journal of Electronic Finance*.- 2009 3(3).
8. H. Naujoks, F.Mueller, N. Kotalakidis. (2017) Digitalization in Insurance: The Multibillion Dollar Opportunity. Bain & Company. URL: <https://www.bain.com>

Iryna Soroka*Ph.D. in Psychology,**Assistant Professor,**Jindal Institute of Behavioural Sciences**Sonapat, Haryana, India**orcid.org/0000-0003-1132-488X***SPECIFICS OF TEACHING CONFLICT MANAGEMENT COURSE AT UNIVERSITY**

Abstract. *The objective of the article is to introduce the content and specifics of teaching a course of conflict management in organizations. The work presents the theoretical material: the notion of conflict; macro, meso and micro factors, influencing the occurrence of conflicts in organizations and types of conflicts. The author's model of conflict management is described. It includes two blocks: "Diagnosis" of subjective (socio-psychological) and objective factors and "Strategic actions" at the subjective and objective levels for their correction. Subjective factors are considered in three aspects: cognitive, emotional and behavioural. Objective factors (organizational and managerial) imply material support (wages), working conditions, leadership style, etc. The paper also suggests the set of practical activities aimed to develop conflict management skills. The prospects for the further research are recommended.*

Introduction.

In modern world the need for conflict management skills is becoming increasingly important. Social, economic and psychological factors make conflict inevitable during the working process in organizations. The ability to manage conflict situations is one of the most important components of professional competence of the individual. Modern education should balance theory and practice to prepare students for real world challenges, to enable them to acquire necessary hard and soft skills for their future careers. The course on conflict management in organizations was created taking into consideration students' active participation in practical activities, assignments are often carried out in groups, which involves sharing, cooperation, communication and empathy. Practical work makes students independent and increases their confidence. At the same time practical work is an application of theory. Theory creates a strong base for practical work.

For successful management of conflicts in modern organizations it is necessary to analyze sources, reasons, types of conflicts arising, which is introduced in the theoretical part of the course. Students also get familiar with the conflict resolution model comprised of cognitive, emotional and behavioural components. The cognitive component – is the knowledge of theory, understanding and adequate perception of organizational conflicts. The emotional component refers to emotions that prevail in the company interaction (positive or negative), and the ability to control them. The behavioural component involves a high level of conflict resistance and collaboration as a style of behaviour in a conflict. Conflict management skills are developed by means of class discussions, debates, creating power point presentations, readings, case studies, games, role plays, projects and using techniques of art therapy (metaphorical cards, picture drawings, film reviews, and a collage).

1. Sources and types of conflicts in organizations

Theoretical material, which is introduced to students in the form of presentations, reading assignments from different scientific publications, online research and educational documentary videos, informs them about definition and brief historical outlook of notion of conflict, sources of conflict and specifics of conflict management in organizations.

Using the terms of Mudrik A. [14], *macro factors, meso factors and micro factors* influence the occurrence of conflicts in organizations. *Macro* factors (macro – large) – events in the state, society, which directly or indirectly affect the activities of the staff. Different views on political events in the country, the economic crisis, and government activities lead to discussions and conflicts. Budget cuts, unpopular resolutions and government innovations reflect the mood and working conditions in the organization. *Meso* (intermediate) factors are considered at the level of organizations. These are the following: socio-economic condition of the organizational activity in the country as a whole and the particular conditions in a definite city; unequal or unfair distribution of workload; insufficient equipment, outdated technological support; style of leadership/management: authoritarian, democratic, liberal etc. Each style has its own advantages and disadvantages, which must be taken into account by managers in certain situations.

As for *micro* factors: an important feature of conflict is the nature of the need that a person seeks to satisfy. If any of the needs (physiological, safety, love, esteem, and self-actualization) are not satisfied this also can lead to conflicts within an organization. Conflicts can arise because of individual and psychological differences (abilities, temperament) [5]; differences of interests, values and approaches to solving problems; gender and age differences, generation gap are also factors of problems and conflicts [15; 16]; clash of egos and cultures; bullying and (sexual) harassment. The phenomenon of conformism can also cause conflicts within the organization. The group gives its members protection, approval and support. As soon as the person deviates from the norm by behaviour or statements, one can be excluded from the group.

Socio-psychological climate in the team is one of the decisive factors for successful organization. The socio-psychological climate of any institution is manifested in the form of a set of psychological conditions that contribute to or impede the productive activity of an individual in the group. Such climate can be favorable, unfavorable, and neutral. The most important features of a favorable socio-psychological climate of the team are divided into subjective and objective [10].

Subjective features: mutual assistance; trust; free expression of opinions; awareness of the members of the team about the tasks and status; creation conditions in the team for professional and creative activity, self-realization and self-development of each employee; job satisfaction (by its content, pay, organization of work).

Objective features: high performance indicators; low turnover; high level of work discipline; absence of tension and conflict in the team, etc. Negative psychological climate in teams is characterized by opposite signs. It leads to low results in work, tension in personal relationships, conflict, results in a desire to quit job. Neutral psychological climate is characterized by a certain balance of both subjective and objective features, but is unstable and can change towards one direction or another at any moment. Research has shown that work-family conflict (WFC) is the source of conflict in organizations as well. It has negative consequences: reducing the sense of satisfaction with life, creating unfavorable conditions for mental work, and increasing intentions to leave work. Work-family conflict is the result of incompatible pressures from work and family roles. There are two areas of this conflict: work interference with family (WIF) and family interference with work (FIW) [9]. According to Carlson D. [3] WIF and FIW each have three sub-dimensions: time, behavioural, and tension conflict. Time-based conflict occurs when the needs of time in one role are incompatible with the needs of another (extra hours at work force family plans to be canceled). Behavioural conflict occurs when behaviour in one area is inappropriate in another (emotional limitations in the workplace are incompatible with the openness that family members expect).

Tension conflict occurs when performing one role has implications for performing another role (caring for a sick child adversely affects one's ability to focus on work). Work and families have both positive and negative effects. Time, tasks, relationships, stress, emotions are shared between work and family. Studies have found a difference in the level of work-family conflict depending on marital status. The research results show that unmarried employees have a higher level of work-family conflict than married ones, which can be explained by the amount of work they receive [8]. There is a general notion that a single person has more free time. Hence the tendency to get more work compared to family colleagues. In the employer-employee relationship the parties need to understand importance of both work and family life. To reduce family interventions, organizations can take measures such as flexible schedules and childcare leave. This can help balance work and family needs.

Having analyzed the reasons of the conflict, we should consider its types and characteristics which are introduced in Table 1.

Table 1. Types of conflicts

№	Criteria	Types	Characteristics
1.	Spheres of conflict manifestation	Economic	Economic contradictions are at the core
		Ideological	At the core of this are contradictions of views
		Social-household	Contradictions of social sphere are at the core
		Family-household	At the core of this is the contradiction of family relationships
2.	Duration and intensity of conflict	Stormy fleeting conflicts	They arise on the basis of individual psychological characteristics of the person; differ by aggressiveness and extreme hostility of the conflicting sides
		Acute prolonged conflicts	They arise because of deep contradictions
		Weak and slow conflicts	They are connected with not very sharp contradictions or passiveness of one of the sides
		Weak and fleeting conflicts	They are related to superficial causes, are of episodic character
3.	Subjects of conflict interaction	Intrapersonal conflicts	They are associated with a clash of opposing motives of the individual
		Interpersonal conflicts	The subjects of the conflict are two (or more) individuals
		Intragroup conflicts	The subjects of the conflict are members of the group
		Intergroup conflicts	The subjects of the conflict are small social groups
		“Person-group” conflicts	Subjects of conflict: on the one side – the person and on the other – a group (micro group)
4.	Social consequences	Constructive conflicts	Such conflicts are based on objective contradictions; contribute to the development of an organization
		Destructive conflicts	Such conflicts are based on subjective causes; create social tension and lead to the destruction of the social system
5.	Duration	Short-term conflicts	Rapid conflicts
		Prolonged conflicts	Lasting for a long time
6.	Interaction between hierarchical levels	Vertical conflicts	Vertical direction in the organization hierarchy
		Horizontal conflicts	Horizontal direction in the organization hierarchy

The table presents the compilation of classification of conflicts by scholars: Emelianov S. [5], Orban-Lembryk L. [15] and M. Afzalur Rahim [17]. This is not a complete list of conflicts classification.

The variety of forms of manifestation, features of the course, the consequences of conflicts do not make it possible to create a single classification. Versatility and psychological complexity make it possible to choose different analysis criteria. Dynamics of a conflict should be considered in conflict management as well. According to Shevchuk D. [19, p.75] general scheme of dynamics is the following:

- 1) pre-conflict situation (latent period);
- 2) open conflict: incident (beginning of conflict); escalation (development) of the conflict; ending the conflict;
- 3) post-conflict period.

2. Conflict management models

According to M. Afzalur Rahim [17, p. 86-89] the process of managing organizational conflict consists of such stages as: Diagnosis (measurement and analysis) and Intervention.

Bernard Mayer [13] suggests diagnosis of conflicts with the three dimensions model. The Dimensions of Conflict (cognitive, emotional, behavioural) model is directed at understanding the dynamics of how conflict unfolds, and how it interacts on different levels. It allows the practitioner or manager of the organization, while diagnosing a conflict, to assess the depth of three important “dimensions”. Cognitive dimension considers what the disputants think about and how they perceive a conflict. In addition to their thoughts and perceptions, people also react emotionally to conflict and express wide range of feelings. In addition to our perceptions about a conflict and our feelings, we also make choices about what actions we will take, how we will behave in response to the conflict. These three dimensions must be seen as being both interrelated with the other two dimensions and at the same time quite independent, requiring their own assessment [7].

Conflict management model

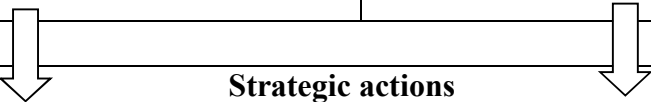
Diagnosis	
<i>Subjective (socio-psychological) factors</i>	<i>Objective (organizational and managerial) factors</i>
<i>cognitive</i> aspect: the level of knowledge about conflict and its prevention; <i>emotional</i> aspect: emotional intelligence, assessment of the psychological atmosphere in the team; <i>behavioural</i> aspect: diagnosis of styles of behaviour.	material support (wages); technical support; working conditions; satisfaction of basic needs; work load; leadership style.
	
Strategic actions	
<i>Subjective level</i>	<i>Objective level</i>
Complex approach to conflict management in organizations taking into account cognitive, emotional, behavioural aspects (analyzing the results of diagnosis and taking measures to correct them).	Application of monetary and non-monetary motivation systems. Creating favorable working conditions. Use leadership styles that are relevant to the interests of employees.

Developed by the author of this paper as a result of the research Conflict management model, includes two blocks: “Diagnosis” of subjective (socio-psychological) and objective (organizational and managerial) factors and “Strategic actions” at the subjective and objective levels for their correction.

Diagnosis can be carried out by interviewing, testing and observing. During diagnosis stage of subjective factors, it is important to gather information about all three aspects.

1. *Cognitive*:

How does staff (conflicting sides) perceive conflict? What do they know about conflict prevention measures? What facts do they focus on? What will change with the parties’ perception of the conflict?

At the cognitive level, members of the staff have certain beliefs and perceptions of conflict. For example, the needs, desires, values of one side may be incompatible with the other. Such a belief makes it impossible to evaluate the situation objectively, and is an obstacle to a joint resolution of potential problems. There is an objective and subjective perception of the conflict. The objective includes facts, events and other data. Subjective perception includes conscious or subconscious assumptions about how a colleague interprets facts or data, and assumptions about the other party’s motives and intentions.

2. *Emotional*: What feelings does the conflict evoke? What are the individual and psychological characteristics of a particular individual? How would changing feelings affect conflict prevention? How effectively can team members control their negative emotions? In addition to understanding and perceiving conflict, employees respond to it emotionally. It is very important to evaluate the conflict within the emotional realm: what are the feelings of colleagues in the team and how those feelings can affect the process of conflict.

3. *Behavioural*: How does behaviour affect an opponent’s actions, feelings, perceptions? What behaviour influences the conflict between colleagues? At what level is conflict resilience developed? What type of behaviour is used by team members in a conflict situation? How will the change of behaviour affect conflict prevention?

Together with the perception of the conflict and the feelings it generates, the employees’ behaviour in response to the conflict is important. All three aspects are interconnected and, at the same time, independent and require separate evaluation. Diagnosis for each of these components will allow to understand which of them has the greatest impact on the occurrence of conflict in the organization and to begin the search for the strategic actions that will be the most effective for managing it. Equally important is the diagnosis of objective organizational and managerial factors, which can influence dissatisfaction with work and subsequently occurrence of conflicts. Using the method of observation, surveys, questionnaires, it is necessary to collect data on working conditions, workload, degree of satisfaction of basic needs (physiological, security), leadership style, adequate remuneration, etc.

Having realized the diagnosis and analyzed the results, it is necessary to start strategic actions. If the results of the diagnosis detect problematic issues, steps should be taken to improve this state of affairs. Cognitive dimension can be improved with the help of lectures, presentations, seminars, master classes. During the lectures and practical activities, employees will gain sufficient knowledge, change negative attitudes towards the phenomenon of “conflict”. Emotional state can be improved through autogenic training, individual psychological counseling, definite activities and games.

Dealing with behavioural dimension efforts should be made to create the conditions for constructive interaction and cooperation as a style of behaviour. It is necessary to develop the rules of conduct in the organization. Promote a culture of communication, develop effective listening skills. All the corrective actions for the three aspects discussed above can be combined into a system of corporate training for staff of the organization.

Creating favorable working conditions (pleasant interior, technical support, flexible working hours, etc.); the use of monetary and non-monetary motivation systems; creation of a favorable psychological climate; personnel policy (a set of provisions, principles, methods of work with personnel in order to create a team that meets the necessary requirements) – all these actions are effective for conflict management in organizations.

3. Set of practical activities for Conflict management course

“Conflict management in organizations” is a 3 credit elective course which is taught in Jindal Institute of Behavioural Sciences, JGU, Sonipat, Haryana, India. As mentioned above the course consists of theoretical as well as practical parts. Interactive activities are grouped and introduced in three sections: cognitive, emotional and behavioural according to Conflict management model described earlier.

Cognitive section. The course starts with a warming-up activity.

1. A professor gives the following instructions: “I am conflict. Think how you typically react when you experience a personal conflict. Find your position in this room in relation to me which will express your reaction to a conflict. Don’t say anything. Pay attention to your body language, facial expression as well as your distance from the conflict”. After the activity is done, students explain (comment) their position, reaction, posture and gestures. This simple activity shows people’s perception of conflicts.

2. Next step is to define conflict.

Students work individually, writing the definition of conflict (without using any sources).

Conflict is.../ Conflict means...

Then they read some of them to the whole group. There are some definitions of conflict on the slide. The students choose the definition closest to theirs.

1) Conflict is a competitive or opposing action of incompatibles: antagonistic state or action (as of divergent ideas, interests, or persons) [12].

2) Kenneth Boulding defined conflict as, “a situation of competition in which the parties are aware of the incompatibility with the wishes of the other” [2].

3. Afterwards the new activity, called “Two walls” is introduced. Students stand up and come forward to the board. On the wall on the right the statement AGREE is fixed, on the opposite wall there is a sign DISAGREE. The professor reads the statements one by one. If students agree with the statement, they move to the wall with the sign “agree”; if they disagree with the statement, they go to the opposite wall. Also the comments on the opinions are encouraged.

“An eye for an eye will only make the whole world blind.” (Mahatma Gandhi)

“I have a self-made quote: Celebrate diversity, practice acceptance and may we all choose peaceful options to conflict.” (Donzella Michele Malone)

“Conflict is drama, and how people deal with conflict shows you the kind of people they are.” (Stephen Moyer)

“It takes two to resolve conflict.” (Tabitha M.)

“The harder the conflict, the more glorious is the triumph.” (Thomas Paine)

“The greatest conflicts are not between two people but between one person and himself.”
(Garth Brooks)

“Conflict is inevitable, but combat is optional.” (Max Lucade) [4].

4. The professor makes a statement that we usually perceive conflict as something negative and asks students if they have ever thought that conflicts can have positive sides or lead to constructive outcome.

The participants work in groups of 3-4 and fill in the columns in the table with the ideas below.

Table 2. Tipe of conflict

<i>Constructive conflict</i>	<i>Destructive conflict</i>

1. It polarizes or divides teams or groups of people.
2. It builds cohesiveness among the members of a team.
3. It destroys the morale of teams or individual team-members.
4. People change and grow personally from the conflict.
5. The conflict results in a solution to a problem.
6. No decision is reached and the problem still exists.

Then working in pairs, students add at least 2 ideas of their own to the list of constructive functions of a conflict and present ideas to the whole group.

At the end of the cognitive section of the practical part of the course, students are asked to give the feedback:

- What did you like/ dislike the most?
- Have you changed your perception/ your point of view about conflicts?

Emotional section.

1. In warming-up activity in this section students are supposed to get a card with the emotion (angry, annoyed, disgusted, bored, despaired, satisfied, disappointed, embarrassed, worried, shocked, happy, sad, surprised, excited, frustrated, guilty, proud) and using gestures, facial expression they have to demonstrate it. The rest of the group tries to guess. Follow-up discussion: Which emotions were the easiest and the most difficult to show? Why?

2. Mini lecture.

An American scientist Paul Ekman did some research and found out that 80-90% of emotions are universally recognized. He studied emotions in different parts of the world, in tribes, and even people who were blind from their birth expressed emotions in the same way. Paul Ekman classified 7 basic emotions: anger, disgust, fear, happiness, sadness, surprise and contempt. The professor shows slides with people demonstrating different emotions, students have to guess them.

3. Discussion. Students work in groups of 3-4 to discuss the following questions:

- a) Are you an emotional person?
- b) How often and in which situations do you hide your emotions?
- c) What emotions are not easy to interpret? Why?
- d) How aware are we of our facial expressions?
- e) How do facial expressions consciously or unconsciously impact our ability to manage conflict?

f) Is it possible to manage our nonverbal communication? How?

4. Exercise “Mirror”

Think of a person you are in conflict with or you have recently had a disagreement with.

Write: what I like about N. is.... What I dislike about N. is.....

Cross out the name of that person and write your own name. Reread what you wrote and think how much this description reflects your personality. Discuss your ideas in pairs. Report to the whole group.

5. Game “You’ve got a message”.

Write your name on the line **from**, the name of a person from your group on the line **to** and the **task** what he/she should do. Don’t show these cards to each other.

From _____

To _____

Task _____

The teacher collects the cards and one by one reads the tasks, calling the names of the students in line “From” in order to perform them.

Follow up discussion:

- 1) What was your first reaction when you realized you would have to perform your own tasks?
 - 2) Do we ever expect others to do things that we ourselves are unwilling to do?
 - 3) For this activity, we literally had to put ourselves in someone else’s intended shoes. How did that feel?
 - 4) How can the sense of this exercise help to prevent conflicts?
- These games are adapted versions from Mary Scannell’s book [18].

Home assignments:

- Research on the topic of Emotional intelligence. Organize the findings in a power point presentation.
- Emotional Quotient Test [20].

Behavioural section.

1. Warming-up. Group drawing “What is it?”

Students are divided in teams. One person in each team starts by drawing a shape or outline. The drawing is then passed to the next team member who must add to the drawing and so on. Time spent by each person on the drawing is limited to 10 seconds. (The facilitator/ teacher can shout: “change” when the time is up).

No discussion is permitted during the drawing, or any agreement before the drawing of what the team will draw. The last person in team finishes the drawing beyond the time limit.

Questions for discussion:

- 1) Did your team draw anything recognizable?
- 2) How easy was the understanding between team members?
- 3) What was the effect of time pressure?
- 4) Was there a natural tendency to draw supportively and harmoniously or were there more conflicting ideas?
- 5) What was your expectation of the completed drawing? Did it change? Why?

- 6) How does stress and pressure affect our willingness to collaborate?
- 7) What conclusion can we make after this activity?

2. Communication can both cause and remedy conflict. As other skills, effective communication must be learned. Effective communication includes active listening. Students play a game which is called “I’m listening” by Mary Scannell [18].

Instructions: Please take a minute to read your script silently. Do not share your script with your partner. When each round begins, you will have 45 seconds to act out your script.

Roles:

Talker

Great news! You have just won the lottery! You are so excited that when you get to work you approach the first team member you see to tell him/ her all about your good news.

Your role: Tell your partner how this money will change your life, what you plan to do with your winnings, and how happy you are. Be sure to use voice and nonverbal communication to convey your excitement.

Listener

One of your colleagues comes to you with good news. You are very busy and preoccupied. Because you have so much going on, you are multitasking – checking your e-mail, texting, looking through the papers on your desk, organizing your workspace, getting up to go make copies, and so on. You don’t even have time to look up and make eye contact – after all, if you do, your coworker may keep talking! And you have much more important things to do.

Your role: Use nonverbal feedback to indicate that you don’t have time to listen. Everything you do indicates that you are very busy and that your tasks are far more important than taking the time to listen to your coworker.

Discussion

- When you were the talker, what feedback did you receive from your listener?
- How did you feel about that feedback?
- What strategies of effective listening do you know?
- What did you learn in this activity that you could use in similar situations at work?

3. Work individually, think about the last conflict you had. Describe it on the sheet of paper. Exchange the cards with another group(s). People, who take the cards with the problem, should write the solution in turns. Get back the cards and read the possible solutions. Are they helpful? Can you use any of these ideas in your real life? Report your views to the whole group.

4. Video documentaries. Presentation of the material can be done through watching the videos on the topic of the class. Talking about the specifics of intragroup/ intergroup conflicts the following videos can be used:

- Asch Conformity Experiment [1].
- The Bystander Effect: The Death of Kitty Genovese [21].

The follow-up discussion can include such questions as:

- How can this group behaviour cause conflicts in organizations?
- How does the knowledge about conformity and defusing responsibility help to manage (prevent) conflicts?

5. Thomas-Kilmann Conflict Mode Questionnaire [22].

The Thomas-Kilmann Conflict Mode Instrument (TKI) was originally developed as a research tool by Kenneth W. Thomas and Ralph H. Kilmann in the early 1970s. The TKI test is a self-report questionnaire designed to measure how one deals with interpersonal conflict. According to the Thomas-Kilmann model, there are five conflict handling modes: Competing, Accommodating, Avoiding, Collaborating and Compromising. Five conflict modes are placed on two dimensions: Assertiveness – the degree to which a person tries to satisfy their own concerns; Cooperativeness – the degree to which a person tries to satisfy other people’s concerns. Students are required to take the test to identify their type of behaviour in a conflict.

6. Topics for presentation.

The following topics can be proposed to students as home assignment or group project with the presentation in the class.

1. Work-family conflicts.
2. Stress as the source of conflicts.
3. Creating positive psychological climate in organizations as the way to prevent conflicts.
4. Satisfying people’s needs in an organization as the means of preventing conflicts.
5. Burnout as the source of conflicts.
6. Leadership styles and conflicts in organizations.

Revision

To revise the material, the following activities and techniques can be used:

1) Case study. Using “Conflict management model” students are required to work on a case study proposed by the teacher. They need to study the case, diagnose it, analyze the results, and suggest strategic actions.

2) Metaphorical cards can be used to find the resources for managing conflict situations. Students can choose the card which they associate with their problem. Describe what they see, what the conflict is and so on. Then from another pile of cards without looking they choose one which can be the solution to their conflict or some resource (a person, a thing, an event). The card is described and afterwards the action plan is designed to help them manage the conflict.

3) A group collage can be used as the revision of the learnt material. Students are equipped with paper, colour pencils, highlighters, magazines, a pair of scissors and glue. Working as a group they have to prepare a poster (collage) as a visual aid for their presentation on the topic “Conflict management in organizations”.

After taking the course “Conflict management in organizations” students are asked to write a feedback. They should note what they found useful and interesting in the course, if their perception of conflicts has changed and what needs more consideration and practice.

Conclusions.

One of the most important components of professional competence is the ability to manage conflicts. Social, economic and psychological factors make conflict inevitable in organizations therefore developing conflict management skills is a vital task of modern education.

The course introduced in this paper, combines the theoretical part with the practical activities. The conflicts in organizations are studied under the prism of macro, meso and micro factors. The types of conflicts in organizations are classified depending on various criteria, such as spheres of conflict manifestation, duration and intensity, social consequences, etc.

The author's Conflict management model is presented and explained in the article. It consists of two blocks: "Diagnosis" of subjective (socio-psychological) and objective (organizational and managerial) factors and "Strategic actions" at the subjective and objective levels for their correction.

The practical activities for developing conflict management skills such as debates, creating power point presentations, readings, case studies, games, role plays, projects, techniques of art therapy (metaphorical cards, picture drawings, film reviews, and collage) are introduced in this work. This material can be used both during a practical conflict management course at educational institutions and as a part of a training programme in organizations.

Future work should focus on problematic issues and specifics of implementing the conflict management training in organizations. Our research also provides the framework for future studies of managing conflicts in multinational organizations.

References

1. Asch Conformity Experiment (2020). Video. Retrieved from: <https://www.youtube.com/watch?v=NyDDyT1lDhA>
2. Boulding, K. (1963). *Conflict and Defense : A General Theory*. San Francisco : Harper.
3. Carlson, D. S., Kacmar, K. M., Williams, M. J. (2000). Construction and initial validation of a multidimensional measures of work-family conflict. *Journal of Vocational Behavior*. Vol.56. Pp.249-276. Retrieved from: <http://www.sciencedirect.com/science/article/pii/S000187919991713X>
4. Conflict Quotes (2020). Goodreads, Inc. Retrieved from: <https://www.goodreads.com/quotes/tag/conflict>
5. Emelianov, S. (2009). *Praktikum po konfliktologii [Conflict Studies]*. Spb.: Piter [in Russian].
6. Frone, M., Russell, M., Cooper, M. (1992). Antecedents and Outcomes of Work-Family Conflict : testing a model of the work-family conflict interference. *Journal Of Applied Psychology*. Vol. 77. Pp.65–78. Retrieved from: <http://www.apa.org/pubs/journals/apl/index.aspx>
7. Furlong, G. (2005). *The conflict resolution toolbox: models & maps for analyzing, diagnosing, and resolving conflict*. Canada : John Wiley & Sons Canada Ltd.
8. Greenhaus, J., Beutell, N. (1985). Sources of conflict between work and family roles. *Academy of Management Review*. Vol. 10. Pp. 76-88. Retrieved from: www.researchgate.net/...Sources_of_Conflict_between_work_and_family_role
9. Greenhaus, J., Collins, K., Singh, R., Parasuraman, S. (1997). Work and family influences on departure from public accounting. *Journal of Vocational Behavior*. Vol. 50. pp. 249-270. Retrieved from: <http://www.sciencedirect.com/science/article/pii/S000187919691578X>
10. Karamushka, L. (2003). *Psychologia upravlinnya: manual*. [Psychology of management]. K.: Milenium [in Ukrainian].
11. Kossek, E. E. (1998). Work-family conflict, policies, and the job-life satisfaction relationship: A review and directions for future organizational behaviour-human resources research. *Journal of Applied Psychology*. Vol. 83. Pp. 139–149. Retrieved from: <http://www.apa.org/pubs/journals/apl/index.aspx>
12. Merriam-Webster dictionary. (2020). Definition of Conflict. Retrieved from: <https://www.merriam-webster.com/dictionary/conflict>
13. Mayer, B. (2012). *The Dynamics of Conflict : a guide to engagement and intervention*. 2nd ed. San Francisco: Jossey-Bass.

14. Mudrik, A. (2000). Social pedagogy: manual. Moskva: Publishing center "Academia" [in Russian].
15. Orban-Lembryk, L. (2010). Psychologia upravlinnya: manual. [Psychology of management]. K.: Akademydav [in Ukrainian].
16. Piren, M. (2003). Conflictology: manual. K.: MAUP [in Ukrainian].
17. Rahim, M. Afzalur (2001). Managing conflict in organizations. 3rd ed. Westport, Connecticut: Quorum Books.
18. Scannell, M. (2010). The big book of conflict resolution games. New York : The McGraw-Hill Companies.
19. Shevchuk, D. (2009). Konflikty kak imi upravlyat [Conflicts: how to manage them (conflictology)]. Moskva: GrossMedia [in Russian].
20. Singh, D. & Chadha, N. (2003). Know Your EQ: Emotional Quotient Test. Retrieved from: <http://www.eqindia.com/wp-content/uploads/2015/09/EQ-TEST.pdf>
21. The Bystander Effect: The Death of Kitty Genovese (2020). Video. Retrieved from: <https://www.youtube.com/watch?v=BdpdUbW8vbw>
22. Thomas-Kilmann conflict mode questionnaire. (1974). Retrieved from: <https://www.uscg.mil/Portals/0/seniorleadership/chaplain/5%20types%20of%20Conflict%20Styles%20Questionnaire.pdf?ver=2020-01-16-150312-330>

Lenina Zadorozhna- Knyagnitska

Doctor of Pedagogical Sciences, Associate Professor,

Head of the Chair of Pedagogy and Education,

Mariupol State University, Ukraine

MANAGEMENT DEONTOLOGY AS A NEW AREA OF SCIENTIFIC KNOWLEDGE IN EDUCATION MANAGEMENT

Abstract. *The article justifies the need for management deontology as a separate branch of ethical knowledge because of the increased requirements for education managers. This issue was studied with the help of three methodological approaches: descriptive, regulatory and constructive. Ethical and philosophical, sociohistorical and sociopsychological conditions of formation and development of management deontology were outlined.*

While making historical and pedagogical analyses of management deontology issues in the national education theories, we identified five criteria that formed the basis for a comprehensive study of the periods: sociopolitical, institutional, regulatory-functional, theoretical-narrative, ethical-deontological. The study identifies and describes the periods of management deontology formation and development:

– the 1st period – (the end of the XIXth century – the beginning of the XXth century) formation of deontological views;

– the 2nd period (1917-1991) – development of management deontology concepts in the theory of education over certain sub-stages (1917-1919 – establishing deontological views in terms of national patriotic priorities; the ‘20s – the end of the ‘30s of the XXth century –outlining the features of the manager of *a new type*; the beginning of the ‘40s – the beginning of the ‘50s of the XXth century – development of professional requirements for education managers in conformity with the Soviet nomenclature; the ‘50s – 1991 – research into the problems of professional duties and responsibilities of a specialist within various fields of scientific knowledge;

– the 3rd period – (1991 – present day) – identifying management deontology as a component of professional deontology.

The analysis of archival documents, scientific papers, educational and public figures of the above –mentioned periods led to the conclusion that the formation and development of management deontology is an overdetermined process that reflects historical and social development of the complex of objective and subjective factors that led to its interdisciplinary focus.

The necessity of considering management deontology as a separate branch of ethical knowledge is substantiated in the article. Philosophical approaches to the definition of the essence of deontological knowledge are analysed. Definitions of management deontology as an applied science as well as an interdisciplinary sphere of knowledge that studies the features of formation and functioning mechanisms of principles and moral standards in the field of education management, which acts as a regulator of manager’s behaviour in professional activities, are given. A set of basic conditions for theoretical and methodological substantiation of management deontology is given:

1. Management deontology has all the features of a science: it is a reliable system of significant knowledge; it is a branch of human activities, a complex social institution which emerged during the division of labour; it has its object (management activities) and subject (behaviour of the manager in professional activities).

2. Identifying the relations between ethics and management deontology is a fundamental question of its distinguishing as a separate branch of scientific knowledge. Professional ethics is the basis of deontology that transfers moral standards into practice, considers the behaviour in professional sphere through the concept of duties, appropriate professional attitude to the participants of the working process.

3. Historically deontological issues in education were not considered with regard to ethics, but they were analyzed in the field of pedagogy, schooling and education management. Deontological requirements for education managers were considered over definite historical periods. Thus, it can be considered as a propaedeutic chapter of the education management theory.

4. The sources of management deontology are professional ethics, which serves as an internal imperative of the education manager's behaviour, and the law, that acts as an external imperative and is implemented through the legal framework of the institution in general and the education manager in particular. The categorical apparatus of management deontology was grounded.

1. Introduction

At the beginning of the XXI century, great attention is paid to ethics of education management because of the increased requirements for school leaders arisen due to the education reform and new challenges that were faced by Ukraine. The development of national education progressed with regard to the tasks defined in a number of public documents (Laws of Ukraine *On Complete General Secondary Education* (2020), *On Education* (2017), *On Prevention of Corruption* (2014); Decrees of the President of Ukraine: *On National Doctrine of Education* (2002), *On Urgent Measures to Ensure the Functioning and Development of Education in Ukraine* (2005), *On Additional Measures to Improve the Quality of Education in Ukraine* (2008), *On Measures to Ensure the Priority Development of Education in Ukraine* (2010) and others). These documents consider the key issues of the education sector and focus on changing priorities in the field of education, in particular.

The issue of effective work of the education manager is considered by scientists in the following contexts:

- forming preparedness for management activities (L. Wozniak);
- school management as leadership (V. Yatsenko, G. Dmytrenko);
- intra management (E. Hrykov);
- upgraded content, forms and methods of management activities (L. Danilenko);
- psychology of management education (L. Karamushka, N. Kolominsky, L. Orban-Lembryk);
- work in school management (V. Zahvyazynskyy, S. Hilmanov);
- improvement of professional skills of education managers (B. Krichevsky);
- formation and development of professional skills of education managers (A. Derkach);
- democratization and humanization of school management (V. Behey); management ethics (V. Shepel).

Contemporary science finds it improper to discuss education managers' activities beyond the context of values, ethics and deontology, which involves changing the paradigm of education in general and educational institution, in particular, which should be the basis of *anthropocentrism* [12, p. 9]. Identifying the bases of professional activities of education managers gives an opportunity to reconsider philosophical basis of management that will ensure ethical and axiological contextuality of knowledge, bringing new research subjects, including: methodology of dialogue, management philosophy and philosophical reflection [20, p. 4].

Defining the values, moral and ethical components of management has now become one of the primary issues of scientific research in management philosophy (Yu. Bekh, T. Vasylevska, V. Voronkova, V. Gorbatenko, O. Davydova, A. Ermolenko, V. Knyazev, O. Kiselyova, V. Kremen, A. Leonov, V. Malakhov, O. Novachuk, M. Rudakevych, V. Tsvetkov etc.).

V. Kremen, C. Pazynich, O. Ponomarev believe that formation of national management elite directly depends on ethics and is actually impossible without proper morals and ethical culture [11, p. 371]. It is strengthening of moral and ethical factors that scientists in management consider as the basics of democratic development of society. In particular, O. Tyhonov claims that management that does not fulfill its function in humanistic society turns into manipulation of people: achieving any goals, even immoral and antisocial [19, p. 127]. Yu. Bekh believes that management cannot be performed beyond social moral ideals and beyond the criteria that determine the goals of society [1, p. 93]. L. Gromova considers ethics as a resource for efficient management and for effective decision-making [6, p. 25].

Conceptualization of education management on the basis of anthropocentrism and actualization, and taking into account deontological component of education management are the theoretical bases and concept of the main conditions of management ethics today. However, despite the close attention of scientists to the problems of professional deontological component of education managers' activities, the matter is mainly ignored by modern researchers.

The purpose of the study is to substantiate management deontology as a component of professional deontology which studies the aspects of formation of moral and ethical norms of behavior and professional duties of education managers while performing their professional functions.

Research tasks:

- to analyze sociohistorical background of the formation and development of management deontology as a science of ethics and an interdisciplinary field of knowledge;
- to justify the categorical apparatus of management deontology;
- to characterize conceptual approaches to the understanding of the nature and content of management deontology.

The following methods were used to achieve the goal of the study and to solve the outlined tasks:

- 1) historiographical analysis involving different groups of sources to determine the main stages of formation and development of management deontology;
- 2) historical and pedagogical analysis for theoretical substantiation of the status of management deontology as a component of professional deontology, clarification of the basic directions of the development of the theory of management deontology;
- 3) terminological analysis – to determine the categorical apparatus of management deontology;

4) abstraction, concretization and generalization of theoretical positions in philosophical, cultural, psychological and pedagogical works of Ukrainian and foreign scientists.

The research was carried out on the basis of the following principles:

– the principle of purposefulness, which implies the development and choice of the terminological apparatus of the study according to its purpose; the elimination of minor, irrelevant concepts;

– the principle of scientificity, which requires an objective study and impartial characteristics of basic concepts of the research;

– the principle of determinism, which reflects the presence of various objectively existing forms of interrelation between the concepts that make up the terminological apparatus of the research;

– the principle of historicism, which provides the study of the issue under consideration in its historical development, reflects the dynamics of its development from its emergence;

– the principle of systematicity, which involves the study of this issue as a system and reveals the connection between the elements of this system;

– the principle of interdisciplinarity, which ensures the widest possible use of the achievements of sciences studying the subject of the research from different angles and provide the most complete analysis of its essence.

That is the first time a detailed study of the theory of management deontology as a branch of professional deontology has been carried out.

2. Background of management deontology

The term *deontology* was introduced by the English philosopher and jurist Jeremy Bentham. In the author's work *Deontology or, The science of Morality* (1834), he advocated morality as a means of ensuring “the greatest happiness for the greatest number of people”. However Bentham’s interpretation of the content of deontology as a doctrine of morality subsequently underwent some transformation. Deontology was formed as a specific system of knowledge about norms, according to the requirements of public morality.

Deontology in the broad sense is a system of moral knowledge, moral, professional and legal responsibilities and rules of behaviour for professionals in relation to people who are involved in the working process and social relations of these professionals. However, its place in the modern system of scientific knowledge has not fully been defined yet. In contemporary science, there are the following definitions of professional deontology:

– a system of ethical knowledge about moral, professional and legal obligations and behavior rules of specialists in the sphere of industrial and social relations.(Yu. Kusyi) [13, p. 7];

– a branch of ethics that studies the issues of duties, all forms of moral requirements and relationships (S. Goncharenko, I. Frolov) [7; 21];

– a science of professional behaviour (M. Komlev) [10];

– a branch of professional ethics, which studies the issues of professional duties and requirements, norms of good behaviour in relationships: a specialist and the object of their activities, specialist and society, specialist and citizens, specialists and their attitude to themselves (M. Vasylieva) [2, p. 80];

– competence, tolerance to other people and their ideas, moral responsibilities for the decisions made (G. Kertayeva) [9, p. 21].

Consequently, professional deontology is considered today both as a branch of ethics and an independent science, and also as a new independent interdisciplinary scientific direction.

Distinguishing of professional deontology led to formation of social requirements for coordinating behaviour of representatives of professional groups with the help of specific rules of professional duties and proper behaviour while fulfilling a particular job. Its principles and norms are reflected in professional codes of different specialties related to interpersonal interaction (journalists, lawyers, social workers, defectologists, psychologists, and teachers) that led to the emergence of professional ethics.

The term *management deontology* appeared in 1999 after the publication of I.Smagin's work *Management Deontology as an Aspect of Administrative Reforms* [17]. In his dissertation *Integrative Ideology and its Role in the System of Administrative Reforms* (2002) [16], management deontology is defined as a separate branch of scientific knowledge. The scientist identified the sources of management deontology norms – the theory of professional ethics, professional-ethical codes and the professional oath. I.Smagin focused on the role and importance of management deontology as a safeguard between corporate and integrative ideology in public management.

The scientist concluded that there is a direct connection between the concepts of *management deontology* and professionalism of the education manager. He believes that the norms of deontology consist in the development of the professional's personal norms, which are formed under the influence of professional orientation, psychological, moral and ideological factors and are individual by nature. Moral self-control (the ability of self-regulating and directing one's own behavior) depends on the professional's self-criticism, as well as the level of consciousness, spiritual development and moral culture [18, p. 70].

I.Smagin emphasizes the need to ensure the development of management deontology as a new branch of scientific knowledge in order to counteract the negative manifestations of corporate managerial consciousness [16, p. 19]. However, the substantiation of management deontology at methodological and theoretical levels is not a primary one in his research. The scientist determines the role and place of management deontology in the development of ideological foundations of public administration reforms.

The emergence and development of management deontology is a process constructed historically and socially, and associated with the formation of requirements for the behavior of the education manager during different historical periods. We agree with the point of view of E. Veselova who believes that responsibility as one of the main categories of management deontology was formed long ago and is accepted in any community including the world's one [4, p. 31]. Thus, scientific substantiation of the essence and content of management deontology is impossible without consideration of its genesis, which is a complex, multiple-factor process associated with the formation of requirements for the behaviour of the education manager during different historical periods.

The above-mentioned issue should be considered in terms of two aspects: the first one relates to the features of formation and development of theory and practice of school management; the second one is connected with the development of ethical science in general and professional ethics in particular. The chronological periods of genesis and development of management deontology are determined basing on the results of scientific studies of L. Berezivska, I. Bereka and I. Shorobura, A. Gryshan, S. Zhabenko, S. Maiboroda, V. Marshev, S. Mackiewicz, L. Natochyy, N. Sorochany, L. Prokopenko, O. Filatova, V. Tsybulnikova who studied the periods of formation and

development of various aspects of education management; and the works of M. Vasiliev, G. Vasyanovych, B. Zhebrovsky, G. Kertayeva, B. Kukushyn, K. Levitan, M. Malakhov, L. Horuzha who identify the genesis of the formation and development of professional ethics and deontology.

The researchers identify three types of prior conditions of management deontology:

- ethical-philosophical;
- sociohistorical;
- sociopsychological.

Ethical and philosophical preconditions relate to the objective necessity of regulation of professional behaviour of the education manager by means of morality and law.

Professional ethics, studying the rules of professional ethics, developed on the basis of a generalized practice of professional behavior of the education manager. However, it highlights the issue of awareness and self-realization of a specialist in management. These questions are especially important in management deontology that emphasizes ethics in practical professional activities.

Sociohistorical background of management deontology is connected with objectively crucial influence of the political system, socio-economic relations, formation of national characteristics of the education system and its management. So, moral standards and ethical requirements provide the formation of the standards of professional behavior of the education manager. Constant contradiction between the requirements for the education manager and their opportunities to meet these requirements is the reason for finding a solution to this problem, where management deontology is considered to be a regulator of professional behaviour of the education manager. However, it was distinguished as a separate field of scientific knowledge much later than the theoretical principles of other types of professional deontology were identified (including medical, legal and educational). This happened due to quite late recognition of the education manager as a professional.

Sociopsychological preconditions of the formation of management deontology influence effective communication between the participants of the management process (H. Kertayeva [9, p. 31]), providing a stable positive motivation to work, favorable psychological climate in the team, creating the right conditions for effective professional work of all the members of the management process. So, gradual shift from authoritarian management style in education, changes in the understanding of characteristic features of management activities, improvement of the qualification requirements for the education manager have created favourable conditions for the development of ideas of management deontology. Researches in this area were carried out alongside with the rapid development and approval of other types of professional deontology – medical, police, environmental, educational, psychological, social work and ethics.

3. Periodization of management deontology

Having performed the historical and pedagogical analyses of management deontology problems in the national educational theories, we have identified five criteria that formed the basis for a comprehensive study of periods, namely:

- sociopolitical, reflecting the essence of education policy, the development of education in general and public attitude towards education managers in particular;
- institutional management that reflects the genesis of the institution as a separate sphere of professional activities (a separate institution), with its own working conditions and professional responsibilities;

– regulatory and functional, reflecting the requirements for the education manager and identifying their rights and duties;

– theoretical-narrative that shows the views of local educators, educational leaders and scholars of various historical periods on the personality of education managers and their professional behaviour;

– ethical and deontological, which made it possible to determine the stages of formation and development of professional ethics and deontology in the system of scientific knowledge.

The mentioned above approaches allowed identifying the following stages of the formation and development of management ethics:

1. The end of the XIX – early XX century – time of the birth of deontological views in the field of education, formation of requirements for professional behavior and norms of the education manager.

2. 1917-1991 – time of the development of management deontology concepts in terms of the theory and practice of education management over certain sub-stages:

– 1917-1919 – establishing of deontological views in regard to national patriotic priorities;

– the ‘20s – the end of the ‘30s of the XXth century – shaping the manager of a *new type*;

– the beginning of the ‘40s – the beginning of the ‘50s of the XXth century – developing of professional requirements for education managers in accordance with the Soviet nomenclature;

– the ‘50s – 1991 – researching the problems of professional duties and responsibilities of a specialist within various fields of scientific knowledge.

3. 1991 – present day – the current stage of management deontology development, the period of study of theoretical principles and distinguishing it as a separate branch of professional ethics.

The peculiarities of the development of the theory and practice of education management and requirements for professional activities of the education manager, which were formed in accordance with the normative base and ethical ideas of each historical period, were analyzed. This made it possible to generalize historical, structural and substantive aspects of management deontology, which ensured understanding its status in the system of scientific knowledge.

The analysis of archival documents, scientific papers, educational and public figures of the above mentioned periods led to the conclusion that formation and development of management deontology is an overdetermined process that reflects the historical and social development of the complex of objective and subjective factors that led to its interdisciplinary focus.

4. Determination of the place of management deontology in sciences

A characteristic feature of the term *management deontology* is its multidisciplinary application; it cannot be considered beyond the context of ethical values, psychology, management theory and sociology. A complex of methodological approaches was also used in this research: interdisciplinary, historical, systemic and comparative.

The historical approach made it possible to determine the origin and formation of deontological theory and practice, to carry out a genesis and historical analysis of its development. This enabled substantiating the sources and theoretical basis of management deontology. The interdisciplinary approach provided understanding of the essence of professional deontology, the analysis of its structure and content not only within deontology as a science, but within the scientific fields where it is relevant (medicine, pedagogy, psychology, jurisprudence, journalism, ecology, etc.). Owing to this, the identification of meaningful, logical and functional connection between deontology and professional deontology, as well as the synthesis of related scientific

knowledge, was made. The systematic approach gave an opportunity to define professional deontology as a system that contains structural components inherent to each science. Thus, a systematic approach ensured the formation of adequate understanding of the essence of professional deontology. The comparative approach made it possible to analyze the structural components of professional deontology and professional ethics, to find out their common and distinctive features. Due to this, objective conclusions about the unity or autonomy of these sciences were drawn.

The analysis of the works of Ukrainian and foreign researchers on professional deontology using these approaches allowed formulating a set of theoretical and practical bases of management deontology provisions:

1. Management deontology has all the features of a science:

- it is a reliable system of significant knowledge;
- is a branch of human activities, a complex social institution, which emerged during the division of labor;
- has its object (management activities) and subject (the behavior of the education manager in professional activities must comply with the system of principles, rules, requirements for management morals).

However, it partly uses categories of ethics that does not allow us to characterize it as a *pure* science.

2. The principal aspect of distinguishing management deontology as a separate branch of scientific knowledge is showing its relations with ethics. In that context, the most important thing is not to define the essence of ethical science in general, but its components – professional ethics as a set of ethical guidelines and values that define the system of norms and values which govern human relations, in a particular [5, p. 12; 8, p. 35].

Analyzing ethical issues of professional activities, V.Bralatan, L.Gutsalo, N.Zdyrko [2, p. 15] focus on two aspects – spiritual and practical. Spiritual ethical dimension of professional activities is represented in the terms of ethics as a science of morality objectively determined and a necessary condition for individuals. Practical ethical dimension of professional activities is connected with the specific moral requirements for representatives of certain professions. And they acquire special significance in professional activities, where there occur moral conflict that involves a change of subordination of moral requirements [2, p. 20].

But morality, which is the subject of the study of ethics, does not create the same rules and principles of human behavior, but only analyzes them, theoretically, generalizes, organizes and justifies moral norms, values and ideals, reveals the essence of responsibilities (including professional). Formation of moral norms, values, requirements for professional activities are the subject of professional ethics. [9, p. 17]. Deontology builds clear ethical guidelines for implementation of compulsory professional duties. Formation of deontology led to the transformation of the content of ethics into updated moral requirements for the behavior. [15]

Thus professional ethics is the basics of deontology that puts moral norms into practice, considering the behavior in professional activities through the concept of duty and good professional attitude to the participants of the working process. This professional behavior (in this case, the behavior of the education manager, auth.) is considered in terms of its moral values and ethical ideals.

The main differences between ethics and deontology are shown in Table 1.

Table 1. Comparative characteristics of professional ethics and professional deontology

Professional ethics	Professional deontology
Ethics reflects the spiritual aspect of professional activities, which is revealed in ethics as a science of morality. This science is objectively deterministic and is a prior condition for self-organization of social individuals.	Deontology reflects the practical aspect of professional activities through specific moral requirements for representatives of a particular profession in situations of changing of moral requirements.
Ethics does not create rules, principles and rules of human behavior, but only studies them, theoretically generalizes, organizes and justifies them. Therefore, ethical norms act as a perfect reflection of morality, not its practical embodiment.	Deontology creates clear moral and ethical guidelines in fulfillment of professional duties
Sphere of ethics study: formation of moral norms, values, requirements for professional activities.	Sphere of deontology study: the employee's awareness of the moral and ethical requirements for professional activities and their implementation in practice.
Ethics is based on a long process of moral values formation.	Deontology is based on a relatively quick assimilation of the rules of professional behavior.
Ethics does not cover all aspects of good behavior; it provides only general guidance.	Deontology covers virtually all aspects of good behavior, is universal and substantive.
For the most part, ethical standards are declarative (compulsory for all).	Deontological norms are individual.

The need for distinguishing deontology as a separate discipline and its distinction from professional ethics is emphasized by M.Vasilieva. Her contention is that professional ethics does not cover all aspects of good behaviour, which is studied by professional deontology; deontology is more universal than professional ethics [3, p. 79].

Taking into account all mentioned above, we believe that management deontology is incorrectly considered as part of ethics. The principal difference between ethics and deontology is in their relation to basic values: in ethics it is morality, in deontology it is duty. This feature ensures considering management deontology as an applied science. In addition, theoretical and practical bases of management deontology should take into account the fact that the defining characteristics of categorical apparatus (duties, responsibilities, professional behaviour, behaviour, etc.) are considered within a multidisciplinary approach (psychology, ethics, axiology, sociology), which provides the most comprehensive display of the moral context of implementation of the functions of education management.

The interdisciplinary links of management deontology are shown in Figure 1.

3. Historically, deontological knowledge was not regarded in ethics but in education management, which conditioned the formation of the requirements for education managers. That is why it can be considered as a propaedeutic to education management theory.

4. The source of management deontology is professional ethics, which serves as a moral imperative for education managers and which determines their professional behavior.

Taking this into consideration, we believe that management deontology should be regarded as an applied science and, simultaneously, an interdisciplinary branch of knowledge that studies the features of formation and mechanisms, principles and ethical standards of an educational institution, acts as a regulator of professional behavior of education managers in their professional activities.

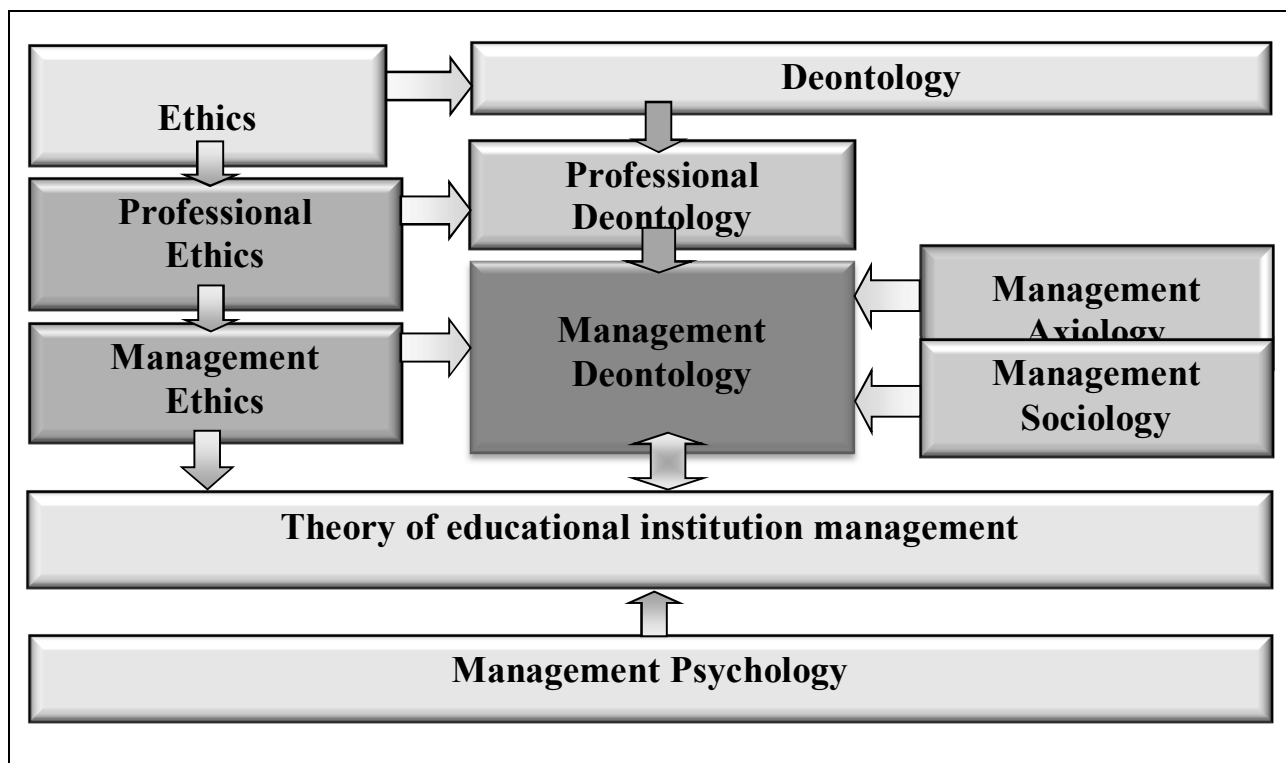

Figure 1. The interdisciplinary links of management deontology

The tasks of management deontology are:

- to determine its nature and categorical apparatus;
- to analyze principles, standards and requirements for professional behaviour of education managers;
- to define management deontology official sources, the correlation between individual position of education manager and the requirements for professional behaviour .

Emphasizing the multidisciplinary nature of professional deontology, modern scientists have not reached a consensus as to its categories. Thus, G. Kertaeva thinks the following concepts to be the basic ones closest to management – pedagogic deontology: *deontology norms, deontological intuitivism, deontological modality, deontic logics, deontic necessity, deontological relationships, deontological readiness, deontological thinking, deontological potential deontological consciousness, deontological credo* etc. [9, p. 57-59]. Ukrainian scientists M.Vasilyeva and L.Khoruzha consider duty, honor, justice, conscience, authority, love to children as the basic concepts of pedagogical deontology [3].

Researchers who consider legal deontology and medical deontology identify the following categories: Legal deontology – *duty, honor, dignity, justice, responsibility, reputation*; Medical deontology – *duty, honor, dignity, mercy, responsibility*.

Psychological deontology differs significantly from these categories and includes the concept of *moral choice, moral reliability and moral responsibility* [4].

Our contention is that the main categories of management deontology are:

- professional duties is a set of moral principles and behavior of managers and is formed as a conscious fulfillment of their professional activities;
- the rules of professional behaviour are the rules and standards governing the behavior of the manager according to professional values and strengthening the stability and unity of the team;

- deontology norm – a concept that characterizes the moral consciousness of the leader, their objectivity and impartiality in treatment and evaluation of professional employees;
- responsibility is the ability to fulfill effective management activities following moral requirements in order to ensure the necessary influence on subordinates to achieve general and personal goals and objectives;
- the authority of the manager is their high social status in the team, which is based on trust, respect, recognition of high professionalism and morality.

Thus, management deontology is a component of professional deontology, characterized by a specific subject, object and categorical apparatus. Management deontology reflects special features of fulfilling professional duties by the education manager.

Determining management deontology status in the system of scientific knowledge, its structure and content is the basis for substantiating the essence of management deontology as an academic subject. This academic subject is essential in providing content for ontological training of education managers at universities. Management deontology as an academic subject is a system of scientific knowledge about deontological science and deontological practice of education management; one of the deontological requirements for education managers and their development is the ability to perform their professional duties properly.

5. Conclusions

The research made it possible to identify the system of theoretical propositions that form the basis for further study of deontology:

1. Professional activities of the education manager is a professional phenomenon that can be studied only on the interdisciplinary level, it is the main type of activities of education managers that requires special knowledge, special personal, professionally significant qualities without which the work and development of the institution is impossible.
2. The main component of professional activities is a person who enters the system of values, power, legal, administrative, economic and financial, interpersonal, educational interaction. The priority is the relations *power – people* which determine the quality and effectiveness of management.
3. The essential characteristics of the education manager is the category of *power* and *value orientations*, the study of which beyond the deontological context is not possible.
4. The education manager is the representative of the authority who implements professional and social values in their work.
5. On the one hand, education managers follow the law, on the other hand, they follow moral requirements which determine their behaviour.

The study of management deontology defined it as an applied science and, simultaneously, as an interdisciplinary field of knowledge that studies the features and mechanisms of formation of principles and ethical standards of an educational institution, acts as a regulator of professional behaviour of education managers.

Prospects for further research lie in the development of theoretical and methodological bases of management deontology at the current stage of scientific development, securing its place in the system of scientific knowledge, clarify its meaning and categorical apparatus.

References

1. Bekh, Yu. V. (2012). *The philosophy of social systems management*. Kyiv: Vydavnytstvo NPU imeni m. Drahomanova [in Ukrainian].
2. Bralatan, V. P., Guzalov L. V., & Zdyrko N. G. (2011). *Professional ethics*. Kyiv: Tsentr uchbovoi literatury [in Ukrainian].
3. Vasylieva, M. P. (2004). *Theoretical basics of teachers deontological preparation*. Doctor's thesis. Kharkiv [in Ukrainian].
4. Veselova, E. K. (2002). *Psychological deontology: world outlook and personal morality*. San Petersburg: Sant-Peteburgskij gosudarstvennyj universitet [in Russian].
5. Gasyuk, L. M. (2004). *The formation of professional ethics of Junior specialists in the sphere of consumer services in the educational work system of the College*. Extended abstract of candidate's thesis. Kyiv [in Ukrainian].
6. Gromova, L. A. (2007). *Ethics of the management*. San Petersburg: Izdatel'stvo Rossijskogo gosudarstvennogo universiteta imeni A.Gercena [in Russian].
7. Ghoncharenko, S. U. (2011). *Ukrainian pedagogical dictionary*. Rivne [in Ukrainian].
8. Kapto, A. S. (2006). *Professional ethics*. Rostov-on-don: SKAGS [in Russian].
9. Kertaeva G. M. (2012). *Basics of pedagogical deontology*. Retrieved from: <http://www.studmed.ru/docs/document44245/> [in Ukrainian].
10. Komlev M. G. (2000). *Dictionary of foreign words*. Moscow [in Russian].
11. Kremen, V. G., Pazynich, S. M., & Ponomarov, O.S. (2008). *Philosophy of the vanagement*. Kharkiv: NTU KHPI [in Ukrainian].
12. Kremen, V. G. (2009). *The philosophy of man-centeredness in strategies of educational space*. Kyiv: Pedahohichna dumka [in Ukrainian].
13. Kussyj, Ju. O. (1998). Pedagogical deontology. *The school world*. Vol. 21. pp. 12-18 [in Ukrainian].
14. Khoruzha, L. L. (2008). Pedagogical deontology. Kyiv [in Ukrainian].
15. Pronevych, O. S. (2014). Deontological standards of professional activities of prosecutors: the values of normative framework and legal regulation. *Law and security*. Vol. 4. pp. 167-173 [in Ukrainian].
16. Smaghin, I. I. (2000). Integrative ideology and its role in the system of administrative reform. PhD Thesis. Kyiv [in Ukrainian].
17. Smaghin, I. I. (1999). Managemental deontology as an aspect of administrative reform. *Proceedings of the Problems of national education in the system of continuous education (Ukraine, Chernivtsi)*. Chernivtsi. pp. 258-259 [in Ukrainian].
18. Smaghin, I. I. (2014). Education management: synergistic implications. *Andragogical Bulletin*. Zhytomyr, vol. 5. pp. 62-78 [in Ukrainian].
19. Tihonov, A. V. (2007). *Sociology of management*. Moscow: «Kanon+» ROOI «Reabilitaciya» [in Russian].
20. Troitska, S. T. (2007). *Ukrainian philosophical anthropology as a theoretical and methodological basis of the teacher professional preparation*. Extended abstract of Doctoral thesis. Kyiv [in Ukrainian].
21. Frolov, I. T. (2001). *Philosophical Dictionary*. Moscow [in Russian].

Nadiia Kirzha

PhD (post graduate) student of the department of innovative and information technologies in education of Vinnytsia Mikhaïlo Kotsiubynskyi State Pedagogical University, teacher of Ukrainian language and foreign literature of Vinnytsia D.K. Zabolotny Medical College Vinnytsia, Ukraine

FORMATION OF STUDENTS' COMMUNICATIVE COMPETENCE IN INFORMATION EDUCATIONAL ENVIRONMENT OF MEDICAL COLLEGE

***Abstract.** The article deals with theoretical and methodological aspects of formation of students' communicative competence in information educational environment of medical college. ICT has been shown as an integral component of educational sector that optimizes and increases its effectiveness. It is possible to apply information educational environment effectively in case of justified and harmonious integration of modern pedagogical technologies into educational system. Using ICT in education has many goals: to increase visibility of provided educational material during students' involvement in educational process, save teachers' time, and increase students' knowledge during acquisition, performance and verification of exercises and other practical tasks.*

Introduction

Essential component of educational sector, which optimizes and improves its effectiveness, is information and communication technology (ICT). National Strategy for Development of Education in Ukraine for the period up to 2021 [11] emphasizes that priority for educational sector development is introduction of the latest technological means of information and communication in educational process. The main tasks for the formation of modern logistical support of educational sector are development of electronic educational tools, implementation of teachers' ICT training, that is, in general, creating necessary conditions for educational system modernization on innovative technological basis. Priority direction for medical college students' training is introduction of information educational environment in education. Advantages of information educational environment include easier understanding and acquisition of knowledge, ability to visualize information, automation of computational activity, creation of conditions for students' independent work. Introduction of information educational environment is slowed down by poor development of didactic material and lack of scientifically grounded practical recommendations for their usage in medical colleges.

National and foreign scientists carry out didactic, psychological and pedagogical studies of the problem of introducing ICT in education. Didactic and methodological development of ICT usage in education is defined in the works of V. Bykov, E. Vinnychenko, O. Vityuk, R. Gurevich, A. Gurzhiy, M. Zhaldak, O. Zhyltsov, M. Kademiya, M. Koziar, V. Kukharenko, N. Morse, V. Oliynyk, Y. Ramsky, O. Spivakovsky and others. Psychological and pedagogical analyzes of the main aspects of ICT usage in education are outlined by V. Bezpalko, T. Zaytseva, V. Zinchenko, Y. Mashbits, M. Smulson and others. Among publications of above-mentioned scholars, the following definition might be found: "Information educational environment is an environment that interconnects educational, methodological and informational resources with using modern information and telecommunication technologies" [4, p. 97]. However, the most successful definition of information educational environment, as it has been confirmed by our research, we find by V. Soldatkin: "It is systematically organized set of data transmission facilities, information resources, interaction protocols, hardware and software, organizational and methodological support, focused on meeting users' educational needs" [14].

According to functional purpose there are three types of information educational environment: 1) information educational environment focused on knowledge delivery; 2) information educational environment focused on independent knowledge acquisition activities; 3) mixed type of information educational environment. “Information educational environment of the first type can be either “open” (for example, software shells that allow teacher to change the content of electronic educational resource or to make a new one) or “closed” (bright example is complex intellectual environments). Communication functions in such information educational environments are mainly used for educational process management. External information resources (distributed databases, virtual libraries, e-learning guides, etc.) may be included in training process, but are generally limited in use as a supplement to the main course content. At the same time, the concept of educational environment is gaining more and more recognition in the context of developing educational strategy, when education is integrated by a wide range of computer capabilities, which is widely used for defining and acquiring knowledge” [4, p. 36].

1. Influence of information educational environment of medical college and Internet on formation of students’ communicative competence

It is possible to use information educational environment in education effectively in case of justified and harmonious integration of modern pedagogical technologies into educational system, enrichment of these technologies, making easier solutions of management tasks. The content and cultural component of information space, which is between scientific-methodological laboratory of certain medical college and global Internet, is increased due to experience, knowledge and traditions accumulated in educational system. Systematic integration of information educational environment should include all types of structures of medical colleges (educational, methodological, scientific, administrative) and should be accompanied by the following tasks: to adapt the structures and existing educational technologies to possible introduction in information educational environment; to adjust technologies to requirements of each structure; to create mutually corrective structures in accordance with information educational environment. A good example of successful ICT realization is appearance of the Internet – global computer network with virtually unlimited possibilities for collecting and storing information, transmitting it individually to each user.

We like the idea expressed by R. Gurevich, an academician of National Academy of Pedagogical Sciences of Ukraine, “in future educational system, when information educational space and information educational environment will make single syncretic entire unit, students will be able to be at any distance from the study center and will be geographically dispersed over a considerable distance. Television, PCs, Internet, e-mail, etc. will provide not only training within one country, but also in international, open, educational information space. Global computer networks, ICTs, digital video technologies will become the dominant component of education of the XXI century in coming decades” [3]. According to Ukrainian scientist O. Bilyk: “Internet is similar to convenient library in many ways, however, it differs by free access, receiving and giving information, dynamics (many web pages are updated daily or more frequently) and interactivity (ability to communicate with anyone in the world at any time). However, this amount of freedom has many disadvantages: there is too much information in the Internet, so it is important to be able to decide if information is necessary or not. Quality of information is also often far from being the best, since there are practically no rules or restrictions on the content of material posted on the Internet that anyone can access, which is the essence of a potential threat to children. The Japanese have already faced the following problems: dependence on online games, fear of live communication, the rise of criminal cases related to dating sites, online abuse and harassment” [2].

Ukrainian renowned scientists R. Gurevich and M. Kademina state that “The Internet has found quick implementation in science, education, communication, the media, including television, advertising, commerce, and other areas of human activity. The first steps in introducing the Internet into education system have shown its huge potential for its development. However, they identified difficulties that need to be overcome for the day-to-day use of the network in educational institutions. However, it should be counted that this requires significant costs for education organization in comparison with traditional technologies, which is connected with necessity to use a large number of technical (computers, modems, etc.), software (educational technologies support) means, as well as with preparation of supplementary organizational and methodological assistance (special instructions for students and teachers), new textbooks and tutorials. Nowadays educational institutions acquire experience, search the ways to improve learning quality and new forms of ICT using in different educational processes. Some difficulties in ICTs usage in educational process arise from the lack of methodological basis for their use, as well as lack of methodology how to develop ICTs for educational sector, which forces teachers to practice only using their own experience and abilities for empiric search of the ways to use information technologies effectively” [5].

However, teacher does not always have opportunity to choose means of information educational environment. Sometimes, medical college does not provide clear list of pedagogical conditions for their usage in teaching process (for example, systems of automated knowledge testing, etc.), according to available electronic educational resources.

During this process, integration of information educational environment is planned and entire educational process is coordinated in detail. First of all, informational goal is formed – to provide real links to implemented electronic educational resources to the curricula, courses, lectures and other educational and methodological documentation. In order to make effective usage of information and educational resources, it is necessary to combine them with traditional educational and teaching materials, using mutual links. Taking into account the substantive transformations in the discipline, new proportions between classroom and independent types of work are being studied, and corresponding thematic changes in lectures and seminars are being made. To ensure productive independent work of students, special tasks are prepared accompanied by training electronic educational resources or tests, modeling electronic educational resources, etc.

In order to implement educational project practically, it is necessary to pre-update educational documentation required for training using selected pedagogical technology, to pre-test existing electronic educational resources, to carry out additional computer training of teachers and students. Integration success is determined by the main criterion: how well we have realized new goals and tasks set during information educational environment implementation. Due to students’ knowledge monitoring, we can find out what kind of intervention the educational process requires to improve adaptation for future medical professionals’ needs. According to this reason the following pedagogical research methods are carried out (questionnaire, testing, observation, conversations, etc.), which allows medical faculty to make an on-going evaluation of effectiveness of the innovation being implemented. To manage educational process means to study continuously how ICT training is being implemented and how to adjust it. In case of serious shortcomings, there is a need for further analysis and workout of ICT integration into information educational environment.

During the final stage of study, existing assets should be studied. In order to evaluate results, research methods with control and experimental groups are used. Such an experimental study should be planned, as it requires considerable resources.

There are other informal methods that are used by most medical college teachers in their practice. Information obtained by teacher during communication with students, their active and creative approach to independent work, positive feedback or, vice versa, insufficient students' feedback, demonstration of passivity, distraction, dissatisfaction with their learning and its effectiveness. The greatest objectivity can be achieved during comprehensive analysis of educational process, individual and personal development, social adaptation, psychological state of students and qualitative indicators of these phenomena. Structural scheme of information educational environment usage in medical college's educational process is completed and concluded in the analysis of results. This allows us to evaluate revealed problems and find ways of improvement with the help of feedback.

Considered introduction of information educational environment into educational system is not characterized by linearity. Due to outlined sequence of steps, the basis for practical implementation appears, which possibly is more complex model. Most steps require revision of previous decisions. Based on this, we can define diversity of opportunities inherent in educational environment as: information educational environment promotes integrity of creative process due to resources necessary for implementation of plans and learning means, and plays role of certain catalyst for identifying personal developing abilities, in case learning organization undergoes certain changes. Theoretical descriptive information shall be provided electronically. During lectures, they mainly discuss problematic issues, and during seminars, teacher gives students creative tasks to focus them on research and scientific cognition, in which students learn not only how to use algorithms for solving expert and inventive problems, but also how to improve information educational environment of medical college. At the same time, teacher implements techniques aimed at activating cognitive activity of future medical professionals: brainstorming, synectics, morphological analysis, etc. in the format of "virtual seminar", which gives chance to all students to reveal their potential.

Essence of activating student's learning through problem-based learning lies not in ordinary mental activity and mental operations to solve stereotypical tasks, it lies in activation of their thinking by means of creation of problem situations, in formation of cognitive interest and modelling of mental processes, adequate to creativity. Student's activity in learning is a volitional action, an active state, which is characterized by deep interest in learning, enhancement of initiative and cognitive independence, intensity of mental and physical forces to achieve cognitive goal of learning. Cognitive activity equips with knowledge, skills, experience; promotes education of students' worldview, moral, ideological and political, aesthetic qualities; develops their cognitive powers, personal formations, activity, independence, cognitive interest; identifies and realizes potential students' opportunities; engages into research and creative activity.

Education is determined by teachers' desire to intensify students' learning activities. As problematic learning activates educational process, it is identified with activation. The terms "learning activation", "student activity", "student cognitive activity" are often different.

Essence of activating student's learning through problem-based learning lies not in ordinary mental activity and mental operations to solve stereotypical tasks, it lies in activation of their thinking by means of creation of problem situations, in formation of cognitive interest and modelling of mental processes, adequate to creativity. Student's activity in learning is a volitional action, an active state, which is characterized by deep interest in learning, enhancement of initiative and cognitive independence, intensity of mental and physical forces to achieve cognitive goal of learning.

It is possible to submit all educational material in a ready-made form: to familiarize with rules, to give examples, but it is possible to go another way: to give students an opportunity to see a pattern. To achieve this, it is necessary to teach students to understand the purpose for which they are performing a particular task and what results they have been able to achieve. Principle of importance of learning activity is important for student. It is the problem situation in a class that allows student to feel this importance. Teachers need to teach students to observe, compare, draw conclusions, and this, in turn, helps to give students ability to gain knowledge on their own, rather than getting them ready. It is difficult to explain students why they need independent activity in class, because not always the result of this activity is positive. Again, problematic situation will come to the rescue, which will arouse interest in students' independent activity and will be a constant factor of activation. However, when engaged in independent activity in a class, students are not left unassisted. Teacher corrects their activities in order not to violate scientific principle during obtaining knowledge.

Analysis of concepts of student activity in learning allows study of such psychological and pedagogical regularities as: formation necessity of learning, creation of positive emotional atmosphere of learning, which contributes to optimal intense of mental and physical forces of students. Idea of learning activating has a great history. In ancient times, it was known that mental activity promotes better memory, deeper insight into objects, processes, and phenomena. Certain philosophical views are based on desire to encourage intellectual activity. Asking a partner problematic questions and his difficulty in finding answers to them were characteristic of Socrates' discussions, the same principle was known in Pythagoras's school.

One of the first supporters of active learning was famous Czech scientist J. Komensky. His "Great Didactics" [8] contains necessary rule to "arise learners' desire for knowledge and passionate commitment to learning", and is directed against verbal-dogmatic learning, which teaches children to "think outside the box".

You can give all the material in ready-made form: familiarize with rules, give examples, but you can go another way: to give students opportunity to see the pattern. To achieve this, they must be taught to understand the purpose for which they are performing a particular task and what results they have been able to achieve. Principle of importance of learning activity is important for student. It is the problem situation in a class that allows student to feel this importance. Teachers need to teach students to observe, compare, draw conclusions, and this, in turn, helps to give students ability to acquire knowledge on their own, rather than getting them ready. It is difficult to explain students why they need independent activity in class, because the result of this activity is not always positive. Again, problematic situation will come to the rescue, which will arouse interest in students' independent activity and will be a constant factor of activation. However, when engaged in independent activity in a class, students are not left unassisted. Teacher corrects their activities in order not to violate scientific principle during obtaining knowledge.

Problematic learning situation allows to solve the problem of educational activity, in which student is organically included as subject of activity. Work activity is caused by contradiction between necessity to introduce creative, productive methods of learning and insufficient workout of their methodological usage in educational process. Based on the analysis of psychological and pedagogical researches, we can conclude that problematic situation is clearly or difficult to understand the subject of difficulty, and in order to overcome it, new knowledge, new ways of action are required. Problem learning is used as a driving force for learning cognition. In problematic situation, student is confronted with contradictions caused by the state of cognitive difficulty and necessity to find ways out of these contradictions independently.

2. Multimedia tools and electronic educational resources for the formation of communicative competence of medical college students

In the context of our study we consider O. Beznosyuk's opinion being of great importance: "ICT usage in students' educational activities increases efficiency and optimizes teaching and learning. The role of creative independent cognitive learning, directed at action and final result, is growing, where students play an active role in knowledge construction. They learn to acquire knowledge and skills independently and prepare to "lifelong learning" because knowledge society will be "able to learn by society" where ICT is a tool capable of creating numerous opportunities for differentiated, motivated, creative, up-to-date learning" [1, p. 269].

Analysis of ICT usage in education has shown that ICT introduction in educational system is changing culture of learning, and these changes are complex – pedagogical, methodological and technological approaches to development of information educational environment are also changing, and therefore information and educational spaces. The task is to adapt these changes and support their positive impact on entire educational process. It is necessary to make educational space useful, effective and interesting. After all, the level and quality of education received affect all human activities. Modern society requires a shift to a fundamentally new level of availability of high-quality education. ICT implementation in education has many goals: to increase visibility of provided learning material during students' involvement in educational process, save teachers' time, and increase students' knowledge during transfer and acquisition, performance and verification of exercises and other practical tasks. ICTs also allow learning to be more personalized, taking into account differences in students' needs:

- with the help of electronic educational resources, students can access required educational materials at suitable time, as well as adjust duration of work with these materials according to their own needs;
- students can easily obtain additional information on curriculum issues they have not mastered, as well as (if there is interest) on subjects beyond the curriculum;
- students have significant opportunities for self-control (tests, exercises, etc.), identifying gaps in their own knowledge and obtaining effective recommendations for their elimination in comparison with traditional textbooks;
- significant objectivity of control measures carried out using technical tools because of elimination of subjective factors;
- e-learning tools can facilitate acquisition of visual material and / or game form, which increases interest of poorly motivated students;
- ICTs enable any student to gain access to electronic educational resources, including webinars designed by leading teachers in Ukraine, which, in some way, allows to reduce impact of shortage of high-qualified teaching staff in individual regions and educational institutions;
- e-learning platforms can contain a large number of tasks, which allow to generate different types of tests and exercises automatically, to prevent write-offs effectively and facilitate deeper understanding of learning materials by students;
- cloud-based learning can be easily tracked remotely by students and faculty;
- classes with well-designed electronic educational materials that take full advantage of modern technology are more economically profitable for students compared to tutoring.

According to Ukrainian scientist L. Petukhova, "information and communication environment has the following advantages: it promotes formation of personality motivation for

content consumption circulating in it; provides access to resources at any suitable time; has a convenient, flexible, friendly, intelligent service that helps a person find necessary information resources, data or knowledge; functions according to person's requests as long as it is needed; provides availability of great volume of information which increases rapidly; allows to organize practically free, convenient in time contacts between any number of people; to provide convenient and flexible exchange of information (in any form) between them; standardizes and integrates all previous traditional means of obtaining, storing, processing and presenting information, data and knowledge required by humanity; undertakes more and more routine operations related to human operations; is gaining more and more control over humanity's data and operations" [12, p. 134].

Socio-economic transformations of Ukraine orient the system of medical colleges to a qualitatively new level of specialist training.

In current circumstances, education in medical colleges is filled with new content and involves both formation of system of scientific-medical knowledge and medical-practical skills, as well as ability of therapeutic interaction with patient, which form the basis of communicative competence of future medical specialist. Communicative competence as a personal quality of medical specialist ensures successful completion of all stages of healing process: formation of patient's information base, physical examination, therapy, evaluation of actions performed. Professional communicative competence of nurse, obstetrician, paramedic with the patient allows to adjust medical history in time by identifying subjective causes of suffering and choosing therapeutic means of communication that make them easier. In this regard, it is necessary to provide scientifically grounded system of medical college students' training for professional communication.

Great attention to scientific solution of the problem of formation of communicative competence of future medical workers of middle level is updated by incomplete description of its specific characteristics, insufficient theoretical development of its formation criteria, fragmentary educational and methodological support. Accordingly, the search for effective methods and means of formation of students' communicative competence during their study in medical college is required.

At the same time, ICT implementation in educational process has its own specifics: it requires teachers to make grounded, clear planning, careful and accurate, clear choice of tools, taking into account the prospect of achieving didactic goals, as well as considering students' individual learning abilities and needs. This makes teachers create electronic educational resources themselves, choosing from available tools provided to teachers who lack professional IT training. Encourages them to create electronic educational resources to achieve certain learning goals. For medical college teachers, this is a new and difficult activity that requires special knowledge of psychological, pedagogical, methodological, technological and ergonomic character, ability to ensure health care (sanitary and hygienic standards for equipment, work with computer equipment, etc.). Motivates medical college management to implement a number of grounded procedures for teachers' training to work with electronic equipment and electronic educational resources.

We agree that "multimedia usage in learning process of basics of sciences helps to increase efficiency of educational process in the field of mastering skills of self-acquisition and presentation of knowledge, contributes to formation of skills to formalize knowledge about subject world, to make predictions of patterns that are studied; to make "micro-discoveries" in subject cognition.

In addition, systematic usage of multimedia in pattern acquisition of a particular discipline area attracts learners to modern methods, basics of sciences and prepares them for intellectual activity in information society of mass communication” [9].

Scientists emphasize the fact that teachers should be able to design their own and student activities in class according to new requirements created by current reality. Because of constant social changes, society needs to predict future considering specifics and pace of its technological and socio-economic dynamics.

ICTs development, development of new powerful capabilities of electronic educational resources to provide various stages of learning, led to appearance of a significant number of electronic educational resources – electronic textbooks and tutorials, electronic lecture notes, workbooks and assignments, multimedia lectures, simulators, control systems, discipline environments, encyclopedias, manuals, etc., each with its own functions and features. Introduction of ICT into educational process has led to significant changes in the system of didactic tools: 1) traditional printed educational tools (textbooks, manuals, workbooks, etc.) are gradually being replaced by electronic ones. Not only the form of storage of educational information has changed, there have been qualitative changes in nature and structure of learning tools.

Modern electronic multimedia didactic tools can no longer be reduced to print editions without losing their functionality; 2) quality of illustrative material used to demonstrate certain theoretical propositions has changed. Contemporary reproductions, photographs, graphics, video, which are digitally stored, create illusion of presence, allow students to view object in various angles and, at the same time, do not lose their quality after being used for many times. Teacher became able to create illustrative material necessary for a particular lesson independently.

Tools quality of symbolic presentation of information – diagrams, tables, graphs – has changed; 3) part of didactic tools that teacher creates for the needs of a particular lesson independently has changed. To prepare necessary didactic tools, teacher can use modern digital devices – video and cameras, audio devices, ready-made fragments of available didactic resources, software which gives possibility to separate, edit and assemble necessary fragments of images, video recordings, presentations, electronic courses, etc.; 4) means for conducting experimental studies have changed.

Laboratory equipment connected to a computer provides new opportunities for real-world experiments in medical college; it became possible to use virtual “laboratories” experiment came close to real scientific research; 5) means of presentation and reproduction of information have changed. Teacher was given opportunity to use new tools, technical devices to reproduce information in electronic multimedia form (projectors, interactive whiteboards, document cameras, etc.) and software – virtual boards, knowledge cards, etc.

According to L. Konoshevsky and O. Konoshevsky, “usage of qualified electronic educational resources in education system makes it much more efficient due to the fact that new opportunities are opened: organization of various forms of student activities for independent acquisition and presentation of knowledge; full usage of ICT opportunities during performance of various types of learning activities; introduction to educational process, along with associative, direct information through the use of multimedia technologies, virtual reality, hypertext and hypermedia systems; objective diagnosis and assessment of students’ intellectual abilities, as well as their level of knowledge, skills, level of preparation for a particular lesson in disciplines of general and professional training, comparing the results of mastering

educational material in accordance with requirements of state educational standard; management of students' educational activity adequately to intellectual level of particular students, level of their professional competence, peculiarities of their motivation taking into account methods being implemented and means of training being used; creation of conditions for realization of students' individual independent educational activity, formation of skills of self-study, self-development, self-improvement, self-education, self-realization" [10, p. 141-142].

Ukrainian scientist O. Pinchuk notes that the term "multimedia" is of Latin origin, which has been spread through English-language sources. The term appeared by combining two English words "multy, multiple" (complex, containing many parts) and "media" (environment, means), or to be more exact, the Latin words "multum" (many) and "media, medium" (environment, tool, method). Thus, literally "multimedia" is translated as "many environments" [13, p. 55].

We like I. Koval's opinion that "multimedia products provide wide opportunities for various aspects of learning. One of the main opportunities and advantages of multimedia tools in case of their usage in educational process are the following: simultaneous usage of several channels of student's perception of information in educational process, thereby achieving integration of information, which is perceived by different student's senses; ability to simulate complex real-world experiments; visualization of abstract information through dynamic representation of processes" [7, p. 71].

Researcher V. Imber states in her dissertation that "multimedia tools allow to create and use computer models, imitations, didactic and developing games in educational process, the main task of which is to arise interest, to create appropriate atmosphere for productive activity of discipline learning" [6, p. 41].

Conclusions

The analysis we have carried out makes it possible to conclude that dynamics of electronic educational resources stimulated significant expansion of didactic tools, which can be used to achieve educational goals. Appearance and development of such tools has greatly increased supply of didactic tools such as e-learning guides, e-courses, multimedia tools, etc.

Teachers of medical colleges are implementing state policy of educational informatization, preparing students for life in information society, which is characterized by rapid appearance of new knowledge, thus promoting creation of new professions and training of relevant specialists all the time. Mobility determines success of each medical college graduate in digital and technology-driven society, their ability to collaborate effectively, to solve problems, to have creative approach to learning and research, etc.

Theoretical and practical base of IOS can be used by teachers of medical colleges, which carry out training of medical, informational, pedagogical direction for students who are future specialists of medical profile, for content modernization of lecture and practical material, special courses, creation of methodological literature; students during implementation of assignments that have individual scientific-research character, while writing coursework, diploma papers, within the practice; postgraduate teachers in such work areas as course retraining and upgrade training.

All of the aforementioned areas of information educational environment application in the medical college are implemented at all stages of training of the future medical professional and are a necessary component for forming the communicative competence of a future specialist.

The main guidelines in shaping the communicative competence of future medical professionals are improving professional competence, ability to work in information educational environment, tolerance, communication skills, ability to cooperate and to independently acquire knowledge and phenomena and processes modeling. Compulsory training of medical staffs in information educational environment has a positive impact on health care delivery as means of improving public health.

References

1. Beznosyuk O.O. (2011). New information technologies of training as a means of intensifying educational and cognitive activity. *Measuring and Computing in Technological Processes*, 1, 267-270.
2. Bilik O. (2011). Involvement of modern media in the educational process of Japanese educational institutions. *Linguistic and Conceptual Pictures of the World: A Collection of Scientific Papers*, 35, 271-276.
3. Gurevich, R. S. (Eds.). (2017). *Educational portal for future teachers*. Vinnytsia: Nilan-LTD.
4. Gurevich, R. S. (Eds.). (2019). *Preparation of future teachers in the educational and information environment of higher education institutions by means of information and communication technologies*. Vinnitsa: LLC Planner Company.
5. Gurevich R., Kademia M. (2011). Information and communication technologies in modern professional education. *Theory and Methods of Vocational Education*, 1, 1-9.
6. Ginger V.I. (2008). *Pedagogical conditions for the use of multimedia teaching aids in the preparation of a future primary school teacher: diss. Cand. ped. Sciences: 13.00.04*.
7. Koval I.A. (2015). *Multimedia technologies as a means of improving the effectiveness of natural science education in general education institutions. Modern information technologies and innovative teaching methods in training specialists: methodology, theory, experience, problems*, 41, 70-74.
8. Komensky, Ya. A. (1940). *Selected pedagogical works: in 3 volumes. - Vol. 1: Great didactics*. K.: Glad. School.
9. Konoshevsky L.L., Konoshevsky O.L. (2005). *Analysis of multimedia tools for intensification and individualization of independent work of students - future teachers of mathematics. Modern information technologies and innovative teaching methods in training specialists: methodology, theory, experience, problems*, 8, 336-344.
10. Konoshevsky L.L., Konoshevsky O.L. (2017). *Use of ICT in the educational process as a means of increasing the accessibility and quality of educational services. Modern information technologies and innovative teaching methods in training of specialists: methodology, theory, experience, problems*, 48, 139-143.
11. Verkhovna Rada of Ukraine (2013). *National Strategy for the Development of Education in Ukraine until 2021*. <https://zakon.rada.gov.ua/laws/show/344/2013>.
12. Petukhov L.E. (2009). *Theoretical and methodological bases of formation of informative competences of future primary school teachers: diss. ... Doctor ped. Sciences: 13.00.04*. Odessa.
13. Pinchuk, O.P. (2007). *The problem of defining multimedia in education: the technological aspect*. *New Learning Technologies*, 46, 55-58.
14. Soldatkin V.I., Lobachev S.L. (1998). *Information and educational environment of open education*. M : MESI.

Iryna Kozub

Ph.D. (Candidate) in Law, Associate Professor, Associate Professor of the Department of Private Law of Yurii Fedkovych Chernivtsi National University

Mykola Bodnaruk

Ph.D. in Law, Associate Professor of the Department of Private Law of Yurii Fedkovych Chernivtsi National University

LABOUR CONTRACT AS A MEANS OF PROTECTION OF LABOUR RIGHTS OF PERSONS WITH DISABILITIES

Abstract. *The article analyses a labour contract as a manifold phenomenon which, along with long established scientific research of labour law in Ukraine in the sphere of its essence and content as a regulator of labour relationships, is also a means of protection of labour rights of employees in general and employees with disabilities in particular. On the basis of the research the conclusion has been made that a labour contract being a means of protection of labour rights of employees is meant to facilitate the realization of social purpose of the labour law of Ukraine which is the protection and security of the labour rights of the employees as an economically weaker party of labour relationships along with achieving the best possible balance of interests of employers and employees. In order to achieve the set goal of legal regulation of labour relationships and recognizing the importance of a labour contract as a means of protection of labour rights of the employees, the lawmakers have determined in Article 9 of the Labour Code of Ukraine the provisions on declaring invalid of those terms of labour contracts which worsen the conditions of employees in comparison with those determined by the labour legislation.*

Introduction

According to current legal legislation, a labour contract is an agreement between an employee and the owner of an enterprise, institution, organization or an authorized body or person pursuant to which an employee shall do the job determined by this agreement, subjecting to internal labour routine, whereas the owner of an enterprise, institution, organization or an authorized authority or person shall pay the employee their salary and provide working conditions necessary to do the job determined by the labour legislation, collective agreement and agreement of the parties. Along with the determined regulatory function, a labour agreement is meant to provide protection of the labour rights of employees in general and employees with disabilities in particular. In order to secure decent life for persons with disabilities, guaranteed by the Constitution of Ukraine and international acts, national legislation obliges the employers to assist them in certain ways. The aim of such assistance is rather noble – it is not only about general socialization of a person with disability but also their return to normal labour and socially useful activity not just for their own good but for the good of the state. The employees with disabilities during the periods of economic instability are that very category of people who need not only additional employment guarantees (the essence of which, in fact, is in the setting of quotas and reserving vacant positions for the above mentioned category of people”) but also proper and sufficient guarantees of labour right realization when performing the job determined by the labour contract. Taking into consideration existing norms of employment of persons with disabilities and rising numbers of employees of the above mentioned category, the analysis of the chosen subject of research is currently important and essential.

The importance and significance of a labour contract for the labour law is completely clear taking into consideration its functions and meaning. This is why there is no surprise in the fact that it has always been of interest to the scientific society. For instance among the modern scientists who did research in the area of labour contracts it is necessary to point out V.S. Venediktov, N.D. Hetmantseva, V. Ya. Hots, V.V. Zhernakov, M.I. Inshyn, L.I. Lazor, A.R. Matsiuk, P.D. Pylypenko, S.M. Prylypko, N.M. Khutorian, H.I. Chanysheva, O.M. Iaroshenko and others. Despite the fact that a labour contract is a phenomenon which has been widely researched the need for further scientific insight into the topic is still there. Moreover, its certain aspects have not attracted enough or are completely out of interest of scientists. For example, the subject of a labour contract as one of the means of protection of employees' rights still lacks substantial analysis. However, it is necessary to mention that the issues of forms and methods of labour rights protection were generally researched in the works by V.S. Andreiev, O.V. Bailo, N.B. Bolotina, V.S. Venediktov, V.V. Zhernakov, I.V. Lagutina, P.D. Pylypenko, O.I. Protsevskiy, H.I. Chanysheva, O.M. Iaroshenko and others. But along with existing scientific works in the above mentioned field such aspect of labour contract which is the subject of our scientific research has not been investigated yet.

The aim of our research is the analysis of a labour contract as a means of protection of labour rights of persons with disabilities. In order to achieve the set aim in the process of research we are going to analyse a labour contract as a manifold phenomenon in the sphere of labour law and determine the essence of this phenomenon as a means of protection of labour rights of employees with disabilities.

Prior to actual analysis of a labour contract as one of the means of protection of labour rights of persons with disabilities we consider that it would be appropriate to mention methods of legal regulation of labour rights protection for that category. The methods of legal regulation of protection of labour rights of persons with disabilities are state and agreement-based legal regulation, whereas when talking about the levels of its implementation there are central and local levels. State legal regulation of protection of labour rights of persons with disabilities is mostly manifested via the adoption of a number of legal acts which is why legal norms are the legal methods of its implementation. Agreement-based regulation of protection of labour rights of persons with disabilities is manifested via labour contracts conclusion (e.g. as a collective agreement at an enterprise, institution or organization as well as an individual labour contract which is concluded between an employer and an employee) [1].

A labour contract is a manifold phenomenon which is why we completely agree with H.I. Chanysheva's opinion that it should be looked into 1) as an agreement on work as an employee; 2) as the main form of enforcement of constitutional rights of a person and a citizen to work which administers the enforcement of other individual and collective labour rights of employees; 3) as a legal fact which is the basis for the origin of, existence in time and development of individual and collective legal relationships; 4) as the central institution of the field and science of labour law; 5) as a legal form of enforcement of the principle of labour protection which characterizes agreement-based procedure of origin, alteration and termination of labour relationships; 6) as a legal form of employee recruitment by an employer. The project of the Labour Code of Ukraine (Article 11) determines one more meaning of a labour contract as one of the means of regulation of labour relationships. Reinforcement in a draft legislation of the role of a labour contract as an individual regulator of labour relationships speaks of strengthening of agreement bases of labour law. When concluded in a written form, a labour contract is also a document unlike labour relationship which is

a theoretical abstract [2, p. 138 – 139]. At this point it is worth mentioning that it is a labour contract which is the most significant legal safeguard for the rights of employees. Thus, as K. Melnyk rightfully says, today the world civilization knows no other better form of enforcement of right to work and enforcement of human rights in the sphere of application of capacity to work than a labour contract. Such contract assists in enforcement and securement of the most important human labour rights: right to proper, safe and healthy working conditions, paid yearly leave, fair pay for labour not lower than minimum wages determined by the law and its timely payment etc. [3, p.108]

To the above mentioned list of manifestations of a labour law we shall add that a labour contract is an important tool of protection of employees' labour rights and, in particular, of those who have been set a disability category as one of the most important functions of a labor contract during the current period of instable economic situation in our country and under the conditions of market economy in general are its social and protective functions which is being underlined in the scientific research by B.A. Rymar. At that, the regulatory and normative functions are no less important as they virtually take their origin from the agreement-based method of administration of labour relationships as a characteristic manifestation of a method of labour law. It is the agreement-based method of labour rights administration that mostly uses such a means of legal regulation as a contract. The main rule here is the one determined in Article 9 of the Code of Labour Laws of Ukraine which emphasizes that the terms of labour contracts which worsen the condition of an employee in comparison with the current legislation norms are hold invalid. It is necessary to point out that these are the conditions that are hold invalid and not the contract itself. M.H. Stolbov in his works also turns our attention to the fact that a labour contract is a valid local regulatory act the provisions of which may be the basis of a court ruling and to the fact that it actually serves the normative and regulatory functions and is aimed at enforcement of normative, regulatory and protective functions [4, p. 8].

Thus, a labour contract may determine any provisions which are going to make up its content. The above mentioned provisions are going to assist in the regulation of such relationships between an employee with a disability and an employer which origin on the grounds of a labour contract and which are called "actual labour relationships" in the Ukrainian science of labour law. The provisions of a labour contract make up its content whereas the rights and obligations of the parties are the content of the legal relationships which occur on the basis of conclusion of a labour contract. Regretfully, the Code of Laws on Labour of Ukraine does not contain the list of provisions that it should have contained leaving wide possibilities of both regulatory and normative character to the parties of a labour contract. The labour law only contains definitions of a labour contract, analyzing which it is possible to come to the conclusion that it should contain such provisions as the place of work, labour function of an employee, time of commencement of a labour contract, payment for labour and the term of a labour contract (the term of a labour contract is a compulsory provision only in the event of conclusion of a fixed-term labour contract, while when the legislation does not provide a possibility to conclude a labour contract for a fixed period of time, the provision on the contract duration is going to be hold invalid). When it comes to the place of work as a provision of a labour contract, it is absolutely necessary to differentiate it from the workplace of an employee.

According to Article 1 of the Law of Ukraine "On the Rehabilitation of Persons with Disabilities in Ukraine", the workplace of a person with disability is the place or area of permanent or temporary placement of the person during the labour process at enterprises, institutions and organizations.

When it comes to a special workplace of a person with disability, it is usually meant as a separate workplace or area which needs additional measures regarding the labour organization of a person with disability taking into consideration their individual needs determined by the disability via adjusting already existing and/or additional equipment, technical facilities etc. In other words, it is a workplace which has been specifically adapted to the needs of a person with disability with the help of special equipment [5].

When equipping a special workplace it is necessary to take into account the recommendations of Disability Determination Services [DDS], professional knowledge and skills of the employee with disability; “limited possibilities” of the person (their certain physiological peculiarities and clinical entities) should be definitely taken into consideration too. Apart from that, it is necessary, according to those needs, implement additional measures of job security which should correspond with the needs of the employee and be the means of prevention of work injuries etc.

Consequently, if DDS in their ruling have determined the need to create a special workplace, the latter should be created or a common one should be readjusted (if possible). Otherwise, an employee may perform their work at a common workplace [6].

The Fund of Social Security for the Persons with Disabilities in their letters of February 29, 2002 No 1/6-51/06 and of November 06, 2008 No 1/6-481/06 confirms the right to employ persons with disabilities to both common and specially adjusted workplaces. However, it will be necessary to take into account individual rehabilitation programs should there be any as well as to follow the recommendations of the DDS [7; 8].

Special work place may be arranged both at a production site and at employee’s home if they are going to telework. In relation to the latter it is necessary for a person with disability to have proper living conditions. A representative of the enterprise where the above mentioned person is working has the right to inspect those conditions along with the representatives of fire and hygiene control authorities. A report is drawn upon such visit.

At that, in order to provide job security, an employer shall provide the employee who is working from home with all the necessary materials and equipment, provide its maintenance and reimburse utility bills (e.g. for the electricity which has been consumed in the course of work) and employment of equipment which is in the employee’s possession (via paying an indemnity for its depreciation) [9]. Workplaces located at the premises of an enterprise, where the equipment, raw materials, technological process etc. may be potentially harmful and dangerous to an employee with disability and, thus, may have an effect on their health both now and in the future, should pass the working conditions qualification procedure on common grounds according to the Attestation Procedure for working conditions of workplaces approved by the Decree of the Cabinet of Ministers of Ukraine of August 01, 1992 No 442 [10].

Thus, a workplace for a person with limited working ability may be: a) a common workplace if under the existing working conditions and physical abilities of such person it may be used for their employment; b) a special workplace, e.g. one which is equipped with special technology, appliances and devices for the work of the above mentioned category depending on their physiological peculiarities or clinical entities and taking into consideration the recommendations of the DDS, professional skills and knowledge of a person with limited working ability. Such workplace may be arranged both at the premises of an enterprise and at employee’s home.

According to Article 16 of the Law of Ukraine “On Protection of Labour”, the enterprises utilizing work of persons with disabilities shall create proper working conditions taking into account recommendations of social and medical assessment board and individual rehabilitation programs, take additional measures regarding the job safety which correspond the specific needs of this category of employees [11]. This is why the owner of an enterprise, institution, organization or an individual who is using hired labour shall provide the employee with disability with a workplace adjusted to their needs and which conforms to current legislation and working recommendations of a DDS. This is the provision of Law which is the guarantee of right for free work for persons with limited working abilities when performing their job tasks [12].

Taking into consideration all the above mentioned, regardless the agreement of the parties of a labour contract, if a labour contract is concluded with a person with disability, who, according to the conclusions of a DDS and individual rehabilitation program, needs a special workplace, the employer shall provide them with one and use the workforce of such employee only at such workplace. The situation is different when at the moment of signing a labour contract a person with disability does not provide the employer with all the necessary paperwork (the recommendations of a DDS and Individual Rehabilitation Program, which is, in fact, is recommended to be executed by the person with disability themselves, but is compulsory for the employer). In this case a person with disability cannot claim the right to realize their legal labour rights guaranteed by the legislation of Ukraine.

At that, if a labour contract is concluded with a person with disability whose labour may be used at a common workplace then it is quite likely that a future employee will agree with the employer and determine in an agreement not only the place of work but also the workplace. The above mentioned is possible, taking into consideration the fact that neither the Code of Laws on Labour of Ukraine nor the labour legislation in general do not provide a complete and comprehensive list of provisions of a labour contract which actually corresponds the nature of a contract as a legal phenomenon. The possibility to determine not only the place of work but also the workplace in a labour contract with a person with disability corresponds Article 9 of the Code of Laws on Labour of Ukraine. This article determines a labour contract as a means of protection of labour rights as it emphasizes that the provisions of a labour contract which worsen the condition of an employee in comparison with the provisions of current legislation are hold invalid. This instruction by the legislation enables us to come to the following conclusions: 1) legal regulation of labour of persons with disabilities is implemented via normative and agreement-based regulation; 2) minimum standards of the legal state of an employee are set at the central level; 3) the means of protection of labour rights which is used within the agreement-based labour regulation is a labour contract the provisions of which shall not worsen the conditions of an employee in comparison with the current legislation. Thus, the situation when a labour contract determines not only the place of work but also the workplace seems quite likely.

Clear definition of the content of a labour contract, namely whether it provides not only the place of work but also the workplace, it important for the purpose of protection and security of the interests of both an employee and the employer. This is so because an offer by an employer regarding the change of a place of work according to Article 32 of the Code of Laws on Labour of Ukraine will be seen as an offer to transfer an employee which requires their consent. A transfer of an employee without their consent is forced labour which is prohibited according to Article 43 of the Constitution of Ukraine. Whereas the change of workplace of an employee, which has not been

determined as a provision of a labour contract, is the transfer which, considering the provisions of the Code of Laws on Labour of Ukraine, is the right of an employer which they may exercise without an employee's prior consent. In the case when a labour contract determines the workplace as well, the offer of an employer regarding the change of a workplace will become an offer to alter the labour contract which is only possible by mutual agreement of the parties. Understanding possible criticism regarding certain limitations, determined by Article 32 of the Code of Laws on Labour of Ukraine, of the employer to transfer an employee to another workplace under the circumstances of mutual agreement on this issue as a provision of a labour contract, we would like to emphasize the following. The Constitution of Ukraine (Article 64) refers to constitutional rights and freedoms of a person and a citizen which may not be restricted except for the cases predetermined by the Constitution itself and not to the rights determined by the Code of Laws on Labour of Ukraine. The Code of Laws on Labour of Ukraine provides only for the invalidity of those provisions of a labour contract which worsen the condition of employees and not employers. Thus, it is quite logical that the conditions which worsen the legal status of an employer in comparison to those determined by the regulations of the labour law (which an employer actually agreed to) are hold valid.

It is necessary to point out that the very demand to transfer an employee with disability may be filed by an employer as well as by the employee. Regarding an employer such initiative might be both personal and required by the regulations of the labour law as in certain cases an employer is obliged to transfer an employee with disability to another position. At that, we would like to note that the very fact of assigning the status of a person with disability to an employee is not a ground to transfer them to another position. In this case the grounds for transfer may be e.g.: a) medical report issued to the employee at regular medical examination; b) if according to the ruling by a DDS an employee is assigned the status of a person with disability and they are recommended to transfer to another position. In the above mentioned cases we believe that the reason for decisions by medical institutions regarding the transfer of an employee to another position is not disability but possible future deterioration of their health and working abilities. In general the need to transfer an employee with limited working ability within the same enterprise (institution, organization) to another permanent job not determined by their labour contract and due to their physical condition may occur if their job does not correspond the recommendations of a DDS (i.e. is counter-indicative to their state of health) and if the job which they are performing is not counter-indicative but is not performed properly due to the worsening of their working ability.

Coming back to the analysis of a labour contract as a means of protection of labour rights we would like to repeat that, in fact, any provisions agreed by the parties may be included into one provided those provisions do not worsen the condition of an employee in comparison with the regulations of the labour law. Thus, it is of great importance to determine the content and amount of legal rights and guarantees of their execution when concluding a contract with a future employee with disability. One peculiarity of the exercise of the right to labour by persons with disabilities via concluding a labour contract is that for them this possibility is objectively limited by the framework of preservation of their working abilities and counter-indications to certain types of work due to their physical condition. At that, it is not only the physical condition that has effect on the working ability of an employee but also the level of its loss. The above mentioned factors are going to be crucial when deciding on such an important provision of a labour contract as labour function which to some extent is going to depend on the ruling of a medical and social examination board or

(medical consultation board for underage persons) and individual rehabilitation programs. Both these institutions proceed with a medical expertise of professional suitability of persons with disabilities which is done, first of all, for the occupations (professions) which they had or studied before as well as for the occupations (professions) they are likely to obtain in future.

It is necessary to state the list of professions and the qualification level which is preserved at one or another level of professional suitability. It is obligatory to state whether a person is suitable for the corresponding occupation:

- in full capacity;
- with certain limitations of the volumes of performed jobs and determination of number of working hours.

It is also required to list the professions and occupations which are recommended to be obtained at professional training and retraining.

The medical and social examination board as well as the medical consultation board provide a detailed description of all the factors and elements of the future labour activity of a person with disability which has to contain counter-indications according to the physical condition of a person with disability to certain types of professional activity along with the details of working conditions (their difficulty, intensity, work and rest schedule, form of work organization, hygiene factors etc.) [13].

Thus, when defining the labour function of an employee with disability, an employer should take into consideration not only their professional skills and knowledge but necessarily follow the recommendations of medical examination board and individual rehabilitation program as well as take into account the interests of a person with disability. At that, an employer should also consider the fact that the physical condition of such employee should not have a negative effect on the health of other people (both staff members and those people who are going to be in contact with the above mentioned employee in the course of performing their labour function).

When it comes to such an important provision of a labour contract as the salary of employees with disabilities we would like to point out the following. Article 43 of the Constitution of Ukraine states that every person has the right to work not lower than it is determined by the law. According to Article 3-1 of the Law of Ukraine "On the Remuneration of Labour" [14] the rate of remuneration of an employee for the fully performed monthly (in hours) workload may not be lower than the minimum salary. Along with that, in the case of conclusion of a labour agreement on the terms of part-time employment as well under the circumstances of incomplete performance of the monthly (in hours) workload, the minimum salary shall be paid in proportion to the executed load of work. Thus, provisions on the remuneration of labour of an employee with disability which do not follow the guarantees determined by the state legislation is going to worsen the condition of employees with disabilities and, as a consequence, should be held invalid (Article 9 of the Code of Laws on Labour of Ukraine). Whereas, when there are provisions on part-time employment or part-time working week, the remuneration of labour of an employee with disability shall be held according to the time they have worked or according to work performance (Article 56 of the Code of Laws on Labour of Ukraine).

We could not but turn our attention to the fact that a reasonable question might occur when it comes to the provision on the remuneration of labour of persons with disabilities and namely whether an employee with disability may claim a higher salary when performing the same amount of work on the same position in comparison to another employee. We shall try to answer.

According to Article 9 of the Code of Laws on Labour of Ukraine the remuneration rate depends on the complexity and conditions of the performed work, professional and business qualities of an employee, their work performance and results of the administrative activity of an enterprise, institution or organization and is not limited in its maximum amount. The instruction which determines that the salary rate depends on actual income of an enterprise speaks of the common interests of both an employee and an employer. It goes without saying that the latter is interested in obtaining as much income as possible, however, an employee is interested in it as well as it directly affects their salary rate. Such common interest enables to assess a labour contract from the point of view of a legal phenomenon which is aimed to assist the realization of social objective of the labour law of Ukraine and, in particular, to benefit the interests of both an employer and an employee. It is the balance of the interests of parties of a labour contract and protection and security of economically weaker employee (which in fact arises from the above mentioned article 9 of the Code of Laws on Labour of Ukraine) is a direction of development of labour legislation and its actual social objective. It is difficult to imagine efficient development of labour law without taking into account the interests of employers during the regulation of labour relationships as it may disappear completely. Employers would not be interested in employing personnel on the basis of labour contracts and would only conclude commercial contracts thus ignoring the labour law.

The salary, i.e. the remuneration of labour, calculated, as a rule, in money terms, which is paid by an employer to employees for their performed work, consists of several parts: basic wages, extra wages and other incentive and compensation payments.

Basic wages are the remuneration for the performed work according to the determined workload (rates of work time, performance, service, job duties etc.) It is established in the form of tariff rates (salary) and contract rates for employees and fixed official salaries for civil workers. Tariff scale and schemes of fixed official salaries, rates of workload and wages according to Article 15 of the Law of Ukraine "On Remuneration of Labour" are determined by enterprises in collective agreement; when there is no such agreement, an employer shall agree this issue with the elective body of the first-level labour union organization (labour union representative) which acts in the interests of the majority of employees. Thus, when applying for a job, a person with disability either agrees to be paid according to a corresponding rate which is in force at an enterprise or looks for another employer. They cannot demand to be paid more than the rate determined by the collective agreement of an enterprise or determined by the agreement of employer and labour union or other bodies authorized by the staff. Even supposing an employer agrees to such an offer, then the determination of basic wages of an employee with disability in comparison with other employees who work at similar positions would mean the violation of the principle of equality of labour rights of citizens of Ukraine (Articles 2-1 of the Code of Laws on Labour of Ukraine).

Regarding extra wages we would like to point out that it is the remuneration for overtime work, excellent work performance and ingenuity as well as specific working conditions. They include additional payments, increments along with guarantee and compensation payments which are predetermined by the current legislation; bonus payments regarding the performance of production tasks and functions. In fact, the terms of implementation and extents of increments, additional payments, bonuses, rewards and other incentives, compensation and guarantee payments as well as tariff rates and rates of official salaries are established by enterprises in a collective agreement according to the regulations and guarantees determined by the legislation, general, industry-specific (inter-industry) and territorial agreements. As we can see, extra wages depend both on the employees themselves and on their working conditions.

Thus, it would be quite logical that these wages may be higher or, vice versa, lower in comparison to other employees working at the same enterprise, institution or organization [15-17].

Other incentive rewards and compensation payments as parts of salary are bonus payments by the results of the performance during the year, bonuses paid by special systems and provisions, grant payments, compensation and other financial and tangible payments which are either not predetermined by the regulations of the current legislation or paid beyond the norms determined by the above mentioned regulations. Such payments also depend on the productive activity of an employee, their work performance, ingenuity, business qualities etc.

Having analyzed salary as a provision of a labour contract with an employee with disability, we may state that:

- firstly, it may not be lower than the minimum determined by the state provided the monthly (in hours) workload is performed;
- secondly, the fixed wages rate of an employee with disability is not agreed with the employee personally when they are applying for a job at an enterprise, institution or organization. The employee-to-be either agrees to work under the working conditions in force at the enterprise, institution or organization or they should be looking for another employer. This proves the accuracy of the conclusion previously made from Article 32 of the Code of Laws on Labour of Ukraine according to which the system and rate of remuneration of labour belong to essential working conditions and not the provisions of a labour contract. The parties do not determine independently the remuneration rate; it is determined according to the tariff rates or official salaries rates which are in force at the enterprise, institution or organization. Obviously, under such circumstances the labour contract only states that the remuneration rate is determined according to the forms of payment organization which are in force at the enterprise, institution or organization. However, the situation is different if an employee with disability signs a contract with an individual entrepreneur. In this case, the parties themselves determine and negotiate the provisions of payment in accordance with the regulations of current legislation; and thirdly, the principle of equality of labour rights of the citizens of Ukraine and the principle of equal remuneration for the same work is determinative when stipulating such a provision of a labour contract as labour remuneration.

Conclusions.

On the basis of the previously described research we may state the following. A labour contract is a manifold phenomenon which, along with the function of a regulator of labour relationships, is a means of protection of labour rights of employees in general and employees with disabilities in particular. Being a means of protection of labour rights of employees which is set forth by the legislation, a labour contract is aimed to assist the realization of the social purpose of labour law of Ukraine which is the protection and security of labour rights of employees as the economically weaker party of labour relationships achieving the most optimal balance of interests of both employees and employers. The act of holding invalid by the labour law of those provisions of labour contracts which worsen the conditions of employees in comparison with the regulations of current legislation provides the opportunity to see a labour contract as a means of protection of labour rights of employees. Moreover, from this point of view, a labour contract is an important guarantee of realization of the right to work for the persons with disabilities. It is hard to underestimate the importance and significance of such regulation as these special guarantees for the persons with disabilities are given and determined by the labour law the social nature of which in this case is undeniable.

References

1. Bodnaruk M.I., Kozub I.H. (2019). On the Methods of Legal Regulation of Labour Rights of Persons with Disabilities. *Forty-first International Economic and Legal Discussions: materials of international scientific and practical Internet-conference* (pp. 102-105). Lviv. (in Ukrainian)
2. Chanysheva H.I.(2014). Realization of Human Rights in the Sphere of Labour and Social Security: Problems of Theory and Practice. *Scientific works of National University "Odesa Law Academy"*, 9, 138-139 (in Ukrainian)
3. Melnyk K.Yu., Babenko A.O. (2016). *Problems of Legal Guarantees of Labour Rights of Employees at Concluding, Altering and Termination of a Labour Contract*. Kharkiv, Kharkiv University of Internal Affairs. (in Ukrainian)
4. Stolbov M.H. (2001). *Labour Agreement (Contract)*. Moscow. (In Russian)
5. Law of Ukraine (2005). On Rehabilitation of Persons with Disabilities in Ukraine: Law of Ukraine of October 06, 2005 No 2961-IV. Electronic resource. Retrieved from: <http://zakon3.rada.gov.ua/laws/show/2961-15>
6. Bilova N. (2016). Workplace of a Person with Disability: all you need to know. *Taxes and Accounting*, 67-68.
7. On the Procedure of Employment of Persons with 1st Degree Disability (2008). Fund of Social Protection of Persons with Disabilities. Letter of February 29,2008 No 1/6-51/06. Electronic resource. Retrieved from: <https://buhgalter911.com>
8. On Creation of Places of Work for Persons with Disabilities (2008). Fund of Social Protection of Persons with Disabilities. Letter of November 06, 2008 No 1/6-481/06. Electronic resource. Retrieved from: <https://buhgalter911.com>
9. State committee of the USSR (1981). On Approval of Provisions on Working Conditions for Home-Based Workers. Decree of September 29, 1981 No 275/17-99. Electronic resource. Retrieved from: <http://zakon.rada.gov.ua>
10. Kozub I.H., Shkurei O.A. (2018). Legal Aspect in the Issues of Labour Protection of the Persons with Limited Working Ability. *Yurydychna Ukraina*, 9, 4–11.
11. Law of Ukraine (1992). On Labour Protection: Law of Ukraine of October 14,1992. No 2694-XII. Retrieved from: <https://zakon.rada.gov.ua>
12. Kozub I.H. (2010). *Legal Regulation of Labour of Persons with Limited Working Ability*. Chernivtsi. Chernivtsi National University.
13. Kozub I., Hodetska M.V. (2018). On the Content of Labour Contracts Concluded with Persons with Limited Working Ability. *Law and Society*, 6, 50-57.
14. Law of Ukraine (1995). On Remuneration of Labour: Law of Ukraine of March 24, 1995. Retrieved from: <https://zakon.rada.gov.ua>.
15. Koval V. Institutional determinants of state policy to regulate services markets. *Social and legal aspects of the development of civil society institutions*. Part II.BMT Erida Sp. z o.o., Poland. 2019. 228 p. (109-125).
16. Koval, V. Pukała, R. (2017). Implementation of Regulatory Policy in Economic Activity: Development of the Institute Regulatory Impact Assessment. *Economics. Ecology. Socium*, 1(1), 24-32.
17. Koval, V., Polyezhayev, Y., & Bezkhlibna, A. (2018). Communicative competences in enhancing of regional competitiveness in the labour market. *Baltic Journal of Economic Studies*, 4(5), 105-113.

Nataliia Kraus*Doctor of Economics, Associate Professor**Borys Grinchenko Kyiv University**Kyiv, Ukraine**orcid.org/0000-0001-8610-3980***Kateryna Kraus***Ph.D. in Economics**Borys Grinchenko Kyiv University**Kyiv, Ukraine**orcid.org/0000-0003-4910-8330***Valerii Osetskyi***Doctor of Economics, Professor**Taras Shevchenko National University of Kyiv**Kyiv, Ukraine**orcid.org/0000-0001-5104-1070*

**PLACE AND ROLE OF MARKETING IN INNOVATIVE ENTREPRENEURIAL
UNIVERSITY**

Abstract. *Digital age of human economic relations, which is under the influence of global challenges and institutional and structural changes, is characterized by a new institutional and organizational format. It is clear that the institutional and technological dynamism and conscious choice of Ukraine for European integration and the need to form a new generation of intellectual elite, significantly intensified the problem of continuity of its socio-economic development, identifying the need for its innovation vector. This vector passes through the qualitative application of digital tools of marketing communications of the university ecosystem in terms of promoting innovative ideas and products in combination with traditional ones, which is revealed in this study. Authors focused their scientific attention on the effectiveness of social networks in terms of the use of advertising, the provision of educational services by innovative entrepreneurship university.*

Introduction.

The creative part of society is a source of accumulation of highly qualified human capital, which determines the directions of development of the country, region and organizations. On the other hand, quality human capital is at the heart of an innovative economy. There is a clear and close relationship between the quality of human capital and the innovative development of the economy.

One of the important institutions with increasing returns is the institute of education and science. It not only allows the reproduction of instrumental values (values based on the instinct of skill are created and “instilled” by individuals through well-thought-out social policy, through the expansion of acquired knowledge and education), but also promotes the formation of social ties needed for economic modernization and institutionalization of innovative economy. Good and effective institutions arise only in a society that has achieved a high level of prosperity, which is manifested in the sufficient accumulation of quality capital. For these reasons, there is an urgent need to study various tools of marketing communication of innovative entrepreneurship university in terms of promoting quality educational services in order to form a quality institution of skilled labor.

It is worth noting that in the XXI century, a large number of high-quality and innovative communication tools and the availability of various channels in which marketing processes are conducted, contributes to the introduction of new methods and approaches to managing the policy of educational services. In the field of educational services, the problems of using the concept of integrated marketing communications are becoming increasingly in demand, relevant and require further in-depth research. We are convinced that the optimal combination of paid advertising on Facebook/Instagram and modern, informative and constantly updated content on the website of innovative entrepreneurship university and in social networks should be a priority for the institution of higher education. In essence, the educational institution must act in the form of a certain chain of activities, namely: advertising on social media networks – detailed information about specialties and educational programs on the official website of the university – publications on social networks and Telegram-channel of innovative entrepreneurship university.

We are convinced that it is in the ecosystem of innovative entrepreneurship university that the effective integration of science, education and innovation takes place. This integration should be studied in the framework of the chain of the type “science–education–business”, which has institutional, organizational, financial, structural, marketing, communication aspects of implementation.

1. Digital and traditional tools of marketing communications of university ecosystem in terms of promoting innovative ideas and products

In the field of traditional sales, a representative of the company or seller meeting with a potential buyer in the market can “read” non-verbal signals and on the basis of this information to determine their next steps. But in the digital age, it is still impossible to “read” physical informal signals. As a result, sales become an opaque process and it is difficult to “break down” into individual components. On the other hand, in digital world, users leave large amounts of data, traces and consumers must already read and analyze this data and test different approaches based on them, while spending more time on fine-tuning.

For digital transformation, as for any transformation, culture and mentality play a major role. And in order for the executor of transformation to be able to carry out the task assigned to him and not be hindered by skeptics and enemies, he would, so to speak, need the “permission for moral self-destruction”, the loss of authority. At the same time, it is necessary to support the process of digital transformation in every possible way by expanding the powers and support to remove obstacles, making decisions without worrying about their compliance with traditional ideas.

Elements of innovation culture, to a large extent, promote or hinder the realization of knowledge as innovation. Main ones include: motivational and psychological ability to perceive innovations (knowledge) in the amount from neutral to active participation; readiness to implement innovations (knowledge) through the implementation of various professional innovation functions, available for this special knowledge, skills and abilities.

In traditional companies, which are not part of the infrastructure of innovative entrepreneurship university, are expected in digital age for difficult times for middle and senior managers. The leadership will be forced to abandon the principle of “all against us” and change it to the principle of “together we are a force”. It is expected that in practice this can quickly activate a chain reaction, such as: “I – we”, “control will be replaced by trust”, “instead of directives – autonomy”, instead of perfectionism, we will get experimentation. At a time when the company is moving towards the loss of its market position, the most important thing is to notice and record a

member of the board of directors. This is due to the fact that in the hierarchy, the higher the level, the more distant the members of the leadership from the actual practical actions. Practitioners testify to the following fact: the farther from the advanced, the more filters the information passes before reaching the directors and more chances managers have to be the last to understand what is happening.

These opportunities are automatically opened to small and micro enterprises operating in the ecosystem structure of innovative entrepreneurship university, because there is only teamwork and collaborative relationships between all players in the innovation process.

It is high-quality work of institutes of science and education, in the ecosystem of the university forms its innovative and entrepreneurial content, ensures the dissemination of new approaches, business models, experience, connects chains of innovation, organizes work with experts, promotes scientific and entrepreneurial communication, provides, both tutoring and mentoring, etc. In this regard, the innovation cycle increasingly covers not only science but also education, as it forms the basis (knowledge, motivation, entrepreneurship, competence, social) for the development and implementation of ideas and innovation.

The socio-economic world of the XXI century is dynamic. We are witnessing how the knowledge society is developing at an accelerated pace, which is why it is natural for new evolutionary and revolutionary, that is innovative tools to help society meet certain needs. Socialization, innovation and digitalization of the environment are of key importance for individual, in which social communications between people determine the content. As a result, the demand for communications and the rapid development of Internet is constantly increasing, and more and more social networks are appearing. As part of the problem we are investigating, it should be noted that the main tools and means of Digital Marketing include:

- Search engine optimization (SEO) and search marketing (SEM);
- Social media marketing (SMM), including blogs;
- Content and influencer marketing;
- Automation of content creation;
- Marketing in e-commerce;
- Affiliate programs;
- Direct mailings (E-mail marketing, SMS and MMS mailings);
- Advertising (contextual; banner; teaser; video advertising; advertising in various forms of digital products: e-books, programs, games, interactive billboards);
- Push notifications;
- Press releases in online media;
- Co-creation;
- Cooperation with bloggers and opinion leaders [1, p. 3].

It is the activity of innovative small private entrepreneurship in social networks that has caused the emergence of a new direction in commercial activity called social media promotion, that is Social Media Marketing (a set of measures aimed at promoting products or services of the enterprise, as well as communication with potential existing consumers on Internet platforms of social media resources). Key elements of Internet marketing complex used by the ecosystem institutes of innovative entrepreneurship university are presented in Figure 1.

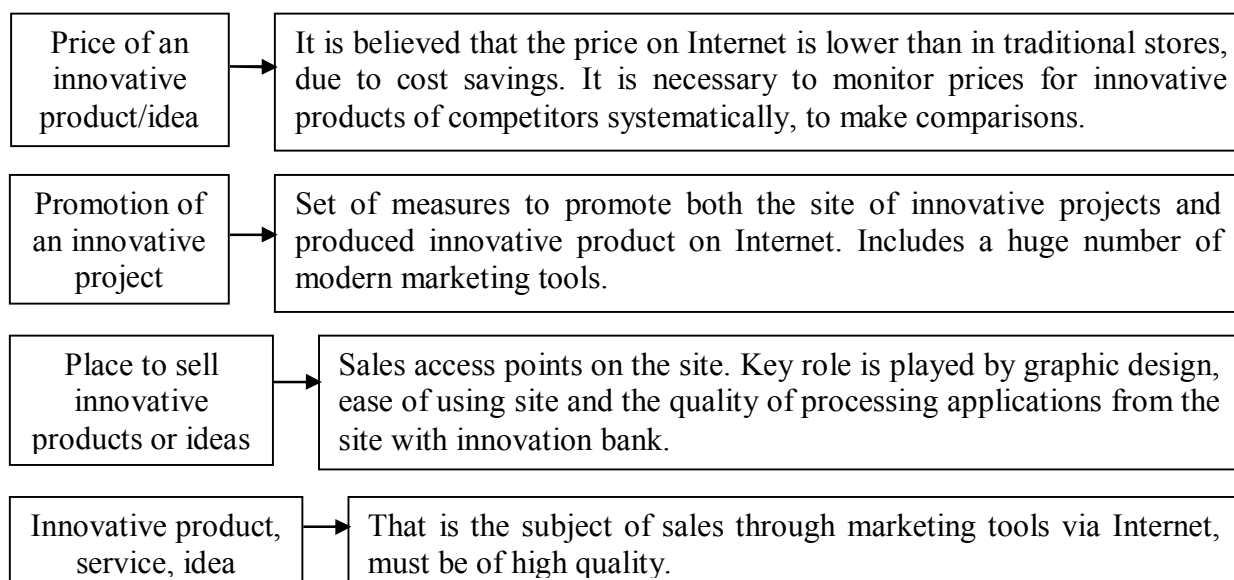

Figure 1. Main elements of Internet marketing complex used by the institutes of the ecosystem of innovative entrepreneurship university (development by authors)

To date, the most effective forms of marketing social media market, used to a greater or lesser extent by innovative entrepreneurship university to promote various innovative projects, products/services are: social networks (specialized, business, general), forums, blogs and micro blogs, photo hosting and video hosting, social bookmarks and catalogs, virtual and multiplayer online games. Undoubted advantages of Social Media Marketing scientists and experts call targeting, interactivity, effective tools for selecting the target audience by various economic, age, educational, professional, status, psychographic, behavioral, territorial and many other criteria, relatively low price and wide possibilities of application of any non-standard ways of promotion.

As of August 2019, there are two most popular social networks in Ukraine: Facebook (53.11 %) and Instagram (16.79 %). The third place is occupied by YouTube, which keeps the positions unchanged both in time and on a territorial basis (9.10 %). In fourth place – the social network Pinterest (8.88 %), which recently, thanks to some innovations, is becoming increasingly popular. Twitter (5.80 %) also holds a fixed position [2, p. 448].

The ideal place for marketing in B2B and B2C segment is Facebook. Business pages and thematic groups are main tool of SMM on Facebook. Main reasons for using Facebook to develop business among innovative companies are that:

- Network has more than 1.4 billion users worldwide and more than 13 million active users in Ukraine;
- 40–50 % of the audience is people from the “golden audience” – clients with medium and high solvency, as well as high receptivity to innovations;
- Large numbers of the world’s largest companies have Facebook accounts;
- Every fourth advertisement placed on social networks is an advertisement on Facebook [2, p. 449]. Therefore, it becomes clear that the use of advertising in these networks by ecosystem institutions by innovative entrepreneurship university seems to be quite promising in terms of both the promotion of educational services and the innovative ideas and projects produced by them.

The advantages of using Internet marketing in social networks by ecosystem institutions of innovative entrepreneurship university in order to promote innovative projects, goods/services are: relatively low cost; quick feedback through polls, comments, likes, reposts, links to Internet

resources; giving companies a “human” face; company budget management; quite a large number of users; possibility to order goods with home delivery. Main tools for social promotion of innovative products created by ecosystem institutions of innovative entrepreneurship university are presented in Figure 2.

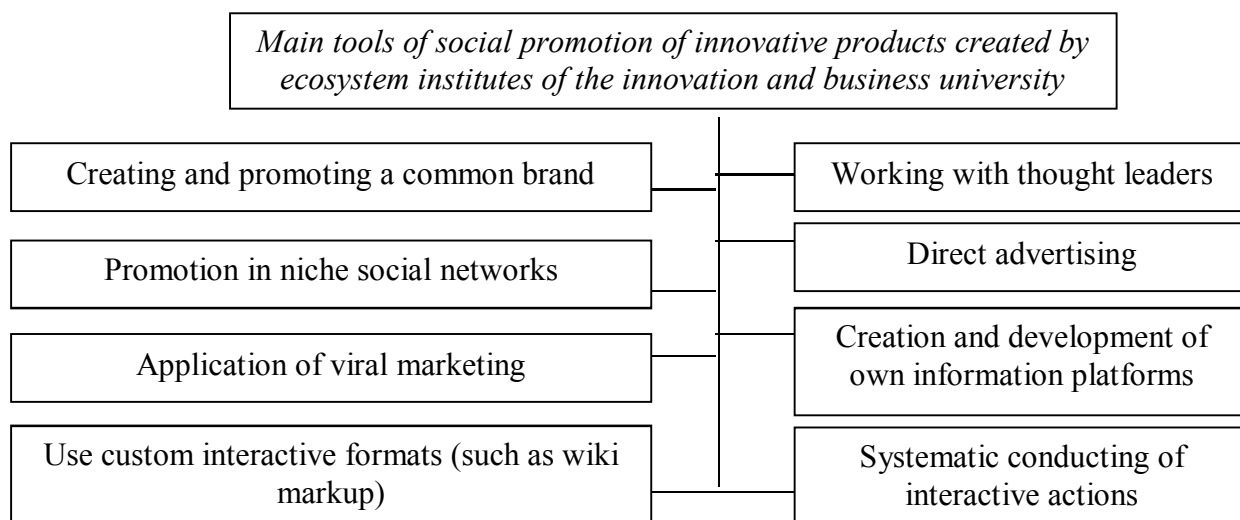

Figure 2. Tools for social promotion of innovative products created by ecosystem institutes of innovative and business university (*development by authors*)

The influence of Internet marketing on the formation of start-up business in the structure of ecosystem of innovative entrepreneurship university is extremely large. To date, there is virtually no company that does not promote itself on Internet. Growth trends can be traced to the constant expansion of online trading platforms and their growing number. Most popular types of advertising used in the work of the institutes of ecosystem of the business university in order to promote innovative products and projects, and those that are most common in social networks are presented in Table 1. We consider it appropriate to note that the technological and socio-economic changes that we observe in society, and this is high rate and range of innovations, necessitate continuous improvement in terms of marketing technologies on Internet, institutions ecosystems of innovative entrepreneurship university (Table 2).

Table 1. Some types of advertising on social networks, which use in their work the institutes of ecosystem of the business university (*development by authors*)

<i>Main types of advertising on social networks, which use in their work the institutes of ecosystem of business university in promoting an innovative product/idea</i>				
<i>Teaser advertising</i>	<i>Targeted advertising</i>	<i>Retargeting</i>	<i>Hidden advertising</i>	<i>Content advertising</i>
Implemented in the form of banners with products offered and displayed on social media pages	Individual advertising blocks with ideas produced by university are shown to the target audience with the necessary, relevant characteristics	Allows you to bring back users who were previously interested in business ideas, innovative projects, startup projects, “nurtured” by research innovators	Not available in the official arsenal of social media marketing tools	Posting announcements about existing innovative projects in business universities on thematic pages of social networks, in order to find partners to expand the business

Table 2. Content and general characteristics of the stages of Internet marketing, which are passed by institutes of university ecosystem during the promotion of an innovative idea, product, educational service

<i>Stages of Internet marketing, passing the institutes of ecosystem of innovative entrepreneurship university</i>	<i>Stage</i>	<i>Content of the stage, its general characteristics</i>
	<i>Base</i>	Formulation of goals of the advertising company of innovative entrepreneurship university on Internet from the standpoint of making a profit as a result of promoting successful project and/or reducing costs.
	<i>Primary</i>	Identifying the potential audience of web site (target audience), which is interested in involved in the implementation of innovation project. Collection and preparation of information that should be requested by users of web site.
	<i>Main</i>	Creating a site Bank of innovative projects or Factory of innovative projects by designing its structure, modern design, providing quality and relevant information content, software operation, placement on Internet.
	<i>Current</i>	Ensuring the collection of statistical information on site traffic to innovative projects.
	<i>Actualization</i>	Purposeful stimulation of visits to the site of innovative projects of entrepreneurship university, target audience.
	<i>Final analysis</i>	Comparison of statistical indicators on visits and sales growth dynamics. At this stage, there is a need to adjust actions on Internet and to organize work of structural units of ecosystem of innovative entrepreneurship university.

development by authors

Changes in consumer behavior due to the development of technology as a result of digital technologies and multichannel (different communication channels) services provided by innovative entrepreneurship university are presented in Table 3.

Table 3. Consumer trends as a result of digital technologies and multichannel service provided by innovative entrepreneurship university

<i>Principles and features of consumer trends</i>	<i>Disclosure of content and general idea about trends</i>
<i>The more, the better</i>	Omnichannel purchases (communication channels combined into one system) are becoming the norm in everyday life
<i>Informed consumer</i>	Information on prices, options and ratings can be obtained at any time
<i>The whole world is in sight</i>	Smartphones have entered our daily lives as a personal device without which existence is impossible
<i>“Erasing the boundaries” between Internet and traditional store in terms of shopping</i>	More “smart” devices are appearing, and individualized offerings are evolving
<i>“Penetration” of online shopping in offline stores</i>	Trends apply to both traditional stores nearby and flagship salons
<i>Principle of constant availability</i>	Customers expect that service, information and interaction are carried out around the clock

development by authors

The existing competition in “struggle for student” in the market of educational services forces universities to implement in their innovative-entrepreneurial activities in addition to traditional marketing technologies, also digital. The implementation of a quality communication marketing policy by innovative entrepreneurship university is an integral structural component in the implementation of marketing program it conducts.

However, the not fully conscious application of modern communication tools in current conditions of fierce competition in the education market cannot fully ensure the achievement of strategic marketing goals of innovative entrepreneurship university. We are convinced that a long-term result can be achieved only with a successful combination and high-quality use of existing marketing communications. It is a successful mix of traditional and digital communication activities into a single, logically designed program that will allow you to more clearly target each marketing tool to the right audience and get a synergistic effect.

1.2. Social networks in terms of the application of advertising for the provision of educational services by innovative entrepreneurship university

Innovative development of personality, in the course of obtaining qualification at the entrepreneurship university, can and should be developed and educated. The system of training a person-innovator must be well thought out and constant with the formation of new institutions and involvement in this process of “new” institutions of innovative development.

The success of economic tools and mechanisms proposed “above” depends on how quickly and efficiently society “learns” the changing paradigms of economic thinking and behavior. Humanitarian, informational, cultural and psychological aspects of the innovation sphere are a new direction for Ukraine’s development. It can be interpreted from a scientific point of view as “humanitarian innovation”, which has a range of socio-humanitarian problems.

The process of choosing a future profession, profession divides people into two categories: those who have decided in advance (early choice), and those for whom the choice is a problem until the application to the institution of higher education (late choice). Individuals who are aware of future professional fields are not burdened with the choice of the institution of higher education.

Foreign scholars believe that the meaning of higher economic education is determined by its importance in the economy and its impact on future of society. In addition, the individual spends a significant part of adult life in the institution of higher education. For many of them, higher economic education is the largest or second most important consumer decision [3, p. 10].

At the same time, personality traits influence the choice of profession. Regardless of the category, consumers have doubts about the correct choice of profession. “Consumers” of economic education programs, guided by common sense, sooner or later question the correctness of the choice. Doubt is inherent in any person who makes decisions in conditions of uncertainty. Since the decision to choose a profession is made at least three to five years in advance, there is always the possibility of error. Doubt is a qualitative feature of the behavior of consumers of educational programs of economic profile. A priori, the choice of profession is problematic for population of civilized countries. Thus, a feature of “consumption” of the educational program in economics at innovative entrepreneurship university, should be considered the complex nature of the choice of higher education in general.

An integral part of any higher education institution (HEI) is its web site. It is the main source of information for potential applicants and it is main tool for the implementation of Internet promotion of educational services of universities. The effective functioning of HEI web site guarantees the transparency of its various educational and scientific activities on Internet, directly and indirectly affecting its competitiveness and demand from target audience, especially entrants in the market of higher education services. For these reasons, ensuring the effective use of university’s web resource, placement and promotion of its web site in social media networks is one of the priority areas of marketing activities [4, p. 391].

The advantages of the use of innovation and entrepreneurship advertising on social networks in terms of promoting their educational services include: low cost, high effect of “virality”, good prospects for development, low competition. Disadvantages include the presence of a more “promoted” brand of competitive free trade, the need for administration, control by network moderators, lack of information in analytics. More substantively, main methods of promoting information on the provision of educational services in social networks, main tasks, advantages and disadvantages for innovative entrepreneurship universities are presented in Table 4.

The strategy for the development of web site of innovative entrepreneurship university is a general action plan aimed at improving its competitiveness. Therefore, its development should be approached carefully, because it will largely depend on the image not only of web site, but also the university and, of course, the number of applicants. It is necessary to carefully analyze the strengths of web site of innovative entrepreneurship university, namely: the availability of English version of web site, the availability of information about creative and professional activities at the university, high position in search engines, relatively simple interface.

Table 4. Characteristic features of social networks in terms of the use of advertising for the provision of educational services by innovative entrepreneurship university

<i>Types</i>	<i>Main tasks set by university</i>	<i>Advantages of using network by innovative entrepreneurship university</i>	<i>Disadvantages of using network by university</i>	<i>Basic methods of promotion in network</i>
<i>1</i>	<i>2</i>	<i>3</i>	<i>4</i>	<i>5</i>
Facebook	rapid increase in consumers of educational services; high-quality and topical promotion of educational services for the younger generation	recognizability, loyalty, reputation management and feedback; 40-50 % of the audience are people from “golden audience” – customers with medium and high solvency, as well as high receptivity to innovation; a large number of the world’s largest companies have Facebook accounts	counteract the negative; research the opinions of potential customers; General thematic posts	independent ways of promotion, competitions, discounts; shares
Instagram	formation of the necessary correct image	a twisted Instagram account can increase brand awareness and interaction with subscribers; you can monitor people’s reactions and make adjustments to the advertising campaign; advertising on social networks has a non-advertising format; Advertising on social networks can be focused for the right audience	time to form a circle of loyal users	“Spin” subscribers; paid publications about university services in thematic acanthuses; hashtag; communication with subscribers influences their understanding and helps to form the desired image of university
Twitter	highest generator of traffic to main site, because “tweets” in it are short, and the user reads complete information directly from main resource	you can write, read and distribute information very quickly; an excellent platform for self-promotion of the company and its development as a brand; Twitter’s audience is very active and mobile, with some posts spreading in the thousands in an hour	not very user-friendly interface, restrictions on writing by characters, because users come to Twitter from mobile phones, main site must be adapted to them	there is a constant communication with users, informing about novelties, actions and special offers, and also conducting communications from subscriber

Continuation of Table 4

1	2	3	4	5
LinkedIn	the most convenient platform for the implementation of marketing campaigns of university, innovative enterprise	you can quickly find potential customers in B2B segment, as this resource was designed specifically for business communication; it is possible to promote both personal sales, B2B segment, goods and educational services intended for a narrow target audience, and goods and educational services of a high price segment; the ability to view the profiles of visitors to the page as an analyst, which will identify stakeholders	personal branding of top managers; attracting new consumers of educational services in the course of personal communication and through targeted advertising	The rule in network works: the more useful information the user uploads to his profile, the more effective the use of network will be; own page of university; personal messages; thematic groups
YouTube	video downloads; promoting information content about educational services quickly	upload your own videos, view and comment on other people's videos, keep video blocks, and create playlists and playlists	increase brand awareness when there is no reason to do so	advertising on social networks is interactive and quickly distributed
Telegram	customer support (solving customer problems with staff or bots)	placement of an unlimited number of files and news	channels are created for information distribution only. I use them as a blog or news feed	constant contact with the audience

Grouped by authors based on sources 2, pp. 449-452; 4, pp. 393; 5, pp. 437-438; 3; 6; 7; 8; 9; 10; 11

Then you need to figure out how to make the most of these benefits. In addition, the availability of information about the creative and professional life of the university gives a clearer picture of the activities of its students. The next important step should be to study main shortcomings of web site, namely:

- Not enough information is available in a foreign language;
- It is not possible to ask a question of interest;
- Low content update;
- Periodic technical failures (issues error 404);
- Slow download time for desktop and mobile versions of web site.

Then it is necessary to offer methods to solve these problems. The next step is to realize the potential by increasing popularity of the site. This point can be implemented by holding creative competitions in which participants could produce popular content that would be under the brand of innovative entrepreneurship university [4, p. 394].

It should be noted that systematic communication with the target audience and the use of modern innovative tools allow entrepreneurship university to provide a stable number of entrants to

any specialty, including reducing the number of graduates of secondary education or reducing the popularity of certain areas. Moreover, a properly constructed communication policy in the presence of high quality education in a particular educational institution makes it possible to ensure a stable number of entrants, even in specialties, the popularity of which in general in Ukraine is declining [12, p. 439].

In addition to the use of social networks indicated by us in Table 4 in terms of the use of advertising, we consider an innovative method of using interactive career guidance measures, such as “Education of the future – socio-economic vacation at Taras Shevchenko National University, as an effective method of providing educational services”. This type of event should be held twice a year, during the autumn and spring holidays. It is a complex of business lectures, business games, master classes and quests in various specialties from trainers, moderators, tutors of innovative entrepreneurship university for three days in a row.

“Trainings from teachers of innovative entrepreneurship university” should be conducted mainly in the field format in educational institutions of different settlements of Kyiv region. In fact, these measures are PR-tools and are important for HEI, as they are one of main tools for shaping the image of an educational and research institution in the market of educational services, which, in turn, is a mandatory element of the market positioning.

In order to build effective communicative work of innovative entrepreneurship university with its potential future students using Internet, the following principles should be followed, namely:

- Systematic, in order to ensure a lasting and long-term effect of social media promotion (it is necessary to communicate on a regular basis throughout the school year). The level of coverage of the target audience on social networks depends on the media plan of the advertising company, the relationship between the indicators of paid and viral advertising. The relationship between increasing the frequency of paid advertising and organic coverage leads to a higher frequency of relevant advertising, which provides an increase in organic coverage [5, p. 436];

- Complexity for the development of various programs for the promotion of HEI and educational programs, research projects using all marketing tools;

- High-quality printing products, which must contain elements of visualization such as pictures, photos, videos, etc.;

- Attentiveness and care in establishing direct contacts with potential entrants through an active university account in social networks, which serves as a “single window” (the administrator advises entrants on any issues, starting from the creation of an electronic cabinet and downloading the necessary documents and ending with peculiarities of conducting classes in various disciplines of curriculum or internship);

- Usefulness of information (resources (sites and accounts in social networks), which contain really thorough, comprehensive and up-to-date information about the rules of admission, conditions and technologies of education in the school, features of specialties and educational programs, employment prospects, novelties and trends in the field related to the future specialty can provide a sufficient number of subscribers and high level of their involvement in communication with the administrator for a long time) [12, p. 443–444].

In social networks, feedback and evaluation of the audience’s reaction to advertising content is carried out using the analysis of preferences, comments and distributions [5, p. 435].

In conclusion, we consider it appropriate to note that social media networks provide a huge audience for the presentation of information content of innovative entrepreneurship university in terms of communication and exchange of key messages in the market of educational services, innovative projects and ideas. Advertising activities of this type of universities in social media, aimed at forming a positive attitude of entrants to HEI, focused on attracting the target audience in advertising campaigns, on nominal scholarships for free education and the formation of a positive attitude to education and its educational services.

Conclusions.

The role of innovative entrepreneurship university in the formation of an effective startup industry in Ukraine is extremely important. This is due only to the direct training of startups, and is one of the most important prerequisites for the successful implementation of innovative projects.

We can say without exaggeration that the institutes of science and education become the basis for the selection of ideas, selection of projects, the formation of research and project teams of research teachers and creative students, effective incubation of business.

The promotion of socially produced innovative services/products grown by innovative projects by ecosystem institutes of the business university has a number of advantages over the use of traditional marketing. These advantages are as follows:

- Advertising on social networks is interactive and quickly distributed;
- Advertising on social networks has a non-advertising format;
- Advertising on social networks can be focused on the right audience.

Digital marketing is much broader than Internet marketing, because it is interactive marketing, which involves the use of digital technologies and channels.

There is no doubt that the active activity of the educational institution in Internet, “liveliness”, demand of the official site in social networks in terms of effective and high-quality communication with potential students is of great importance in the market of educational services in the XXI century.

However, the chaotic use of certain Internet marketing tools in today’s highly competitive market can’t ensure the achievement of strategic marketing goals, and in the promotion of educational services, and innovative projects or ideas produced by entrepreneurship university.

Long-term results can be achieved only if the development of a set of integrated marketing communications by innovative entrepreneurship university. After all, combining traditional and digital communication activities into a single program allows you to more clearly target each tool to the appropriate audience and get a synergistic effect for the implementation of educational services, projects, ideas.

References

1. Melnyk, L. H. & Derykolenko, A. O. (2020). Tools of digital marketing as a means of promoting the products of domestic industrial enterprises. *Efektivna ekonomika*, 3. Retrieved from: <http://www.economy.nayka.com.ua/?op=1&z=7707>. DOI: 10.32702 / 2307-2105-2020.3.7 [in Ukrainian].
2. Shtal, T. V. & Dmytriiev, H. B. (2019). SMM as modern marketing technologies. *BIZNESINFORM*, 12, 446–452 [in Ukrainian].
3. Sullivan, T., Mackie, C., Massy, W. & Sinha, E. (2012). *Improving measurement of productivity in higher education. Panel on measuring higher education productivity: conceptual framework and data needs*/National Research Council, Committee on National Statistics and Board

on Testing and Assessment, Division of Behavioral and Social Sciences and Education. Washington. National Academies Press.

4. Taranishyn, O. O., Kaluhina, N. A. & Sakun, H. O. (2019). Improving the work of web site to strengthen the image of the institution of higher education. *BIZNESINFORM*, 11, 390–395 [in Ukrainian].

5. Zhabyak, S. A. & Kasyanova, N. V. (2019). Evaluation of advertising content in social networks. *BIZNESINFORM*, 11, 434–439 [in Ukrainian].

6. Britchenko, I., Kraus, N. & Kraus, K. (2019). University innovative hubs as points of growth of industrial parks of Ukraine. *Finansovo-kredytna diialnist: problem teorii i praktyky*, 4 (31), 448–456.

7. Kraus, K. M. (2015). *Management of marketing of small trade enterprises*: monograph. Kyiv: Center for educational literature [in Ukrainian].

8. Kraus, K. M. (2017). Innovative hubs as a platform of economic growth: foreign experience and new opportunities for Ukraine. *Marketynh i menedzhment innovatsii*, 2, 196–203.

9. Odnorog, M., Kraus, N. & Kraus, K. (2019). The features of entrepreneurial interactions in the interactions in the agricultural sector in terms of institutional transformation. *Baltic Journal of Economic Studies*, 4, 171–181. Retrieved from: <http://www.baltijapublishing.lv/index.php/issue/article/download/720/pdf>. DOI: 10.30525/2256-0742/2019-5-4-171-181.

10. Osetskyi, V., Kraus, N. & Kraus, K. (2020). New quality of financial institutions and business management. *Baltic Journal of Economic Studies*, 1, 59–66. Retrieved from: <http://www.baltijapublishing.lv/index.php/issue/article/download/766/pdf>. DOI: 10.30525/2256-0742/2020-6-1-59-66.

11. Andrusiak, N., Kraus, N., Savchenko, A. & Iavich, M. (2019). Practices of using blockchain technology in ICT under the digitalization of the world economy. *Proceedings of the international workshop on conflict management in global information networks: 1st International conference on cyber hygiene and conflict management in global information networks* (pp. 80–89). Lviv.

12. Zharska, I. O. (2019). The system of marketing communications of a higher education institution: a combination of “classic” and “digital” tools. *BIZNESINFORM*, 12, 438–446 [in Ukrainian].

Liudmyla Voronovska

PhD in Philosophy, Associate Professor

Cherkasy Institute of Fire Safety named after Chornobyl Heroes of National University of Civil Defense of Ukraine

Cherkasy, Ukraine

orcid.org/0000-0003-2815-2500

Oksana Ivashchenko

PhD in Pedagogical Sciences, Associate Professor

Cherkasy Institute of Fire Safety named after Chornobyl Heroes of National University of Civil Defense of Ukraine

Cherkasy, Ukraine

orcid.org/0000-0003-0978-3075

Yuliia Nenko

Doctor of Pedagogical Sciences, Associate Professor

Cherkasy Institute of Fire Safety named after Chornobyl Heroes of National University of Civil Defense of Ukraine

Cherkasy, Ukraine

orcid.org/0000-0001-7868-0155

PEDAGOGICAL FACILITATIVE INTERACTION IN THE PROCESS OF PROFESSIONAL TRAINING OF PSYCHOLOGISTS

Abstract. *The peculiarities of future psychologists' training on the basis of highlighting the model of facilitative approach are analyzed. Attention is paid to the topicality of forming an individual facilitative style in the process of pedagogical interaction. Modern interpretations of the concept of "facilitation" and scientific approaches to the definition of the concepts "pedagogical facilitation" and "facilitation skills of the teacher" are considered. The conditions of effectiveness of pedagogical facilitation are indicated. The main tasks of the teacher in training a competent specialist are highlighted. The essential requirements to the teacher-facilitator and necessary skills that he should possess are stated. The importance of pedagogical interaction which creates conditions for disclosing students' natural inclinations, self-development of their cognitive, emotional and spiritual needs is emphasized.*

Introduction.

The new system of national education should be oriented towards the training of a psychologist who is competent in the profession and able to respond promptly to situational changes in society. The training of such specialists should be based on the restructuring of the personal preferences of the teacher, which determine his interaction with students and are characterized by an individual style of communication, a way to achieve a learning goal, his creativity. The main task of the teacher is to stimulate and initiate meaningful learning, to develop a creative personality, to train a competent specialist.

Modern philosophy of education, forming and analyzing the worldview paradigm, leads educators to understanding the purpose of educational work, orienting modern educational models on achieving certain qualitative indicators. Considering the problematic issues of pedagogical interaction, we turn to the actual professional values of the teacher and his skills, which can be the basis for determining pedagogical ways of updating and development of educational systems.

Educational practice convincingly shows that one of the most effective models is developmental learning, where particular attention is paid to the development of cultural and educational space, in which conditions are created or constructed to reveal the natural inclinations of students, the self-development of their cognitive, emotional and spiritual needs.

Thus, the problem of providing facilitation in the pedagogical space as a model of developmental learning has become significant today, as evidenced by the variety of research experiences that cover the problem-thematic spectrum of phenomenology of pedagogical facilitation.

1. The structure of facilitative skills of the teacher.

Therefore, the term “facilitation” is derived from the English verb “facility” (in this form it has been used in English since 1610), which in turn is derived from the Latin term “facilis” (translated as “easy, comfortable”). Facilitation is characterized by a set of skills that are used to effectively organize the discussion of a complex problem without wasting time and to accomplish in a short time all planned actions with the maximum involvement of participants in the process. Such a facilitative organization of the group work process, aimed at clarifying and achieving the goals set by the group, will facilitate the effective professional training of future psychologists while using the interactive teaching technologies. The facilitator who guides the discussion process while conducting the classes ensures successful group communication, helps the group understand the overall purpose, and maintains positive group dynamics to achieve this goal in the discussion process, without protecting any of the positions or parties [9].

On this basis, a facilitator is understood as a person who helps to make the process of communication with other people simple and easy, thereby contributing to the identification by the individuals of conditions for their active self-development [23].

In psychology the term “facilitation” is used to refer to a process and phenomenon that facilitates, optimizes, and increases the productivity of a group or individual due to the presence of another person or several people [8].

The term “facilitation” is also widely used in pedagogical literature. The concept of “pedagogical facilitation” was introduced into scientific circulation by the founder of humanistic psychology K. Rogers. According to K. Rogers, the teacher-facilitator helps in the process of development of the child, supports and accompanies it, creates a favorable environment for acceptance, understanding, and at the same time motivates for learning, self-discovery and self-disclosure.

To determine the nature and structure of the facilitation skills, we will rely on the conclusions of modern scholars who have contributed significantly to the study of the phenomenon of pedagogical facilitation.

According to the tasks that the educators in modern information society are currently facing, the following classes of skills are distinguished: constructive, communicative, organizational, didactic, perceptive, suggestive, cognitive, practical and skills in the field of pedagogical technique [12].

We have defined the professional skills of the teacher in modern information society as having a flexible system of conscious, purposeful, interconnected mental and practical actions that allow him to successfully perform educational functions at the general pedagogical, humanitarian levels using innovative technologies, including information and communication technologies, in a changing environment.

Taking into account that the process of training future psychologists is also aimed at acquiring a certain level of professional knowledge, skills that ensure the effectiveness of professional activity, the educational system faces the task of improving the quality of their professional training through modern approaches to learning. Ideas of self-worth, benevolence, openness, self-improvement of each personality are essential for the facilitation of the educational process. The facilitation position of the future psychologist is carried out within the framework of a facilitative approach, which is reflected in the growing role of humanistic psychology, which places at the center of its methodology the personality of a person as a unique holistic system that has the potential for self-development, self-actualization.

The formation of a facilitation position of future psychologists in the course of their professional training can be carried out provided the indirect position of the instructor-facilitator, who will contribute to the formation of independent subjective activity of future psychologists in solving psychological and pedagogical problems that arise in the process of training. Mutually acceptable communication between the facilitator and the future psychologists will create conditions for the personal and professional growth of all participants in the psychological and pedagogical process. From the philosophical and sociological point of view, it is in communication that the essence of human being is reflected. In the process of communication a certain community (primarily based on shared values, interests, beliefs and goals) is formed, the only spatial and spiritual continuum where each participant retains his or her individual personal qualities.

Communication in the philosophical and psychological sense lies in the general information field, because it is not a process of transmitting information as such from the source to recipient. The purpose of communication is the formation by an individual of his own element of information code, which seems to snatch from the general field of information that part of it, which in one way or another, the recipient needs at the moment.

The movement of information in the context of communication is a complex and multifaceted process, which, in addition to the three basic elements (sender - information - recipient), also includes preconditions without which communication cannot take place and be successful. Communication as a process is not limited to a result, and as a result is not a static phenomenon. Communication, considered both as a process and a result, a cause and an effect, a condition and something given, pervades all spheres of reality created by man.

One of the first to analyze the psychological nature of communication in modern psychology, going beyond language communications, was psychiatrist and medical psychologist V.M. Myasishchev. He expressed the idea that communication is a process of direct or indirect technical means of human interaction, in which three closely related components can be clearly distinguished: the psychic reflection of the participants of communication with each other, their relation to each other and the influence on each other.

Due to the fact that in the field of humanistic psychology the concept of “influence” means first of all to help, make easier, stimulate, actualize the need for development, personal growth, it can be called “facilitation”. Having analyzed the works of many researchers, it has become clear that facilitation influence is the main type of influence in the humanistic paradigm, the mechanism of which is based on the dialogical action and certain personal characteristics of the facilitator. V.S. Merlin considered the problems of communication in connection with the solution of the question of change of individual style of activity depending on specific, objective requirements of different types of activity. The question of specificity of individual style of communication and its similarity with style of activity was raised in particular. The central, main function of communication was called influence.

In 1960-1970s communication was regarded as a special type of activity, which in some situations was an independent display of communicative activity, and in others it was involved in more complex activities and is a prerequisite for its successful implementation. At that time the attention of the researchers was drawn to the goals pursued by the participants in the joint activity; the motives that motivated them to perform these activities; the ways they use it.

In the early 1960s the field of social psychology began to develop, which was called “cognition of man by man”. Its founder O.O. Bodalyov proved that the process of communication went through the following stages: a) choosing a partner; b) raising the level of knowledge of the partner initiating communication; c) understanding the psychological characteristics of partners; d) coordination of interaction; e) establishing relationships. All these stages are implemented in the form of psychological activity of partners [2].

O.O. Bodalyov defined interpersonal communication as one of the sides of a holistic communication process in which there were cognitive, emotional and behavioral components. He also formulated a list of personality traits needed for successful communication: the orientation in which other people were at the center of the value system; sufficient level of development of cognitive processes, observation; “social imagination”, intuition, ability to put oneself in the place of another person; the formation of the emotional sphere (the ability to empathize); the ability to choose the most appropriate behavior for another person; flexibility in the choice of means of influence on another person; knowledge of one’s own characteristics and ability to control one’s behavior.

In the 1970s psychological studies of communication began under the guidance of B.F. Lomov. He regarded communication as a socio-historical category, revealing the social nature of human existence. Being an important aspect of the subject’s real life, communication acts as the most important determinant of the entire mental system, its structure, dynamics and development. In the process of communication people exchange ideas, actions, states, present their inner world, master social and historical experience. Actually, the result of the research of B.F. Lomov and his colleagues was the conclusion that a new methodological principle of general psychology was the principle of communication.

In the 1970s O.O. Leontiev developed a theoretical concept of communication, which he considered one of the key categories not only for modern psychology, but also for other human sciences. Communication means “a system of purposeful and motivated processes that ensure the interaction of people in a collective activity, realizing social and personal, psychological relationships and using specific means, especially language” [13].

Special attention of O.O. Leontiev was paid to the study of pedagogical communication. In his opinion, optimal pedagogical communication is the communication in the learning process, which creates the best conditions for the development of motivation of students and the creative nature of educational activities, for the correct formation of personality, ensures favorable emotional climate of learning (in particular, prevented the emergence of psychological barriers), provides management of social and psychological processes in the student team and allows the maximum use in the educational process of the personal characteristics of the teacher [14].

In the 1980s the search for the most optimal typology of communication continued, in particular L.A. Petrovskaja distinguished types of communication by the following criteria: a) subject-subject and subject-object; b) productive and reproductive; c) superficial and deep (personal) [18].

Exploring communication styles, V.M. Kunitsyna separately distinguishes interpersonal trusting communication – that is, the process, the course of which is determined by numerous planned and unplanned contacts, the accumulation of subjectively meaningful, emotionally colored information about another person, the construction and stabilization of relationships, culminating in a psychological relationship. In the formation of trust interpersonal communication she defines seven stages: formal communication, trusting communication, contact, communicative compatibility, communicative success and psychological intimacy (or friendship) [11].

Y.M. Yemelianov introduced the concept of “interpersonal situation” into scientific circulation. The main structural unit of analysis of interpersonal communication was named not the individual, but the relationship, the interaction of people who communicate with each other. This means that each of the participants in the communication significantly affects the behavior of the other, between their statements and actions there are causal dependencies. Accordingly, the researchers of interpersonal communication are interested in the interpersonal behavior (or “transaction”, if you use the term of American psychologist E. Berne), which has new qualities compared to the individual actions of each participant outside the interaction situation.

In 1990-2000s scientific researches were performed in the fields of social motivation of interaction and communication of people, social intelligence (M.L. Kubyshekin, V.M. Pogolsha, I.V. Kuznetsova and others); interaction and interpersonal relationships of people of different age groups (T.B. Yushachkova, T.V. Kazantsev, D. Berstein, etc.), moral and ethical problems of interpersonal relationships and communication (A.A. Moiseev, M.T. Sultanov, O.A. Zhdanov, D.R. Pavlov and others). Socio-psychological mechanisms of personal influence in the process of communication were studied by V.M. Pogolsha. According to her the symptom-complex of personality traits, such as self-confidence, adaptability, active position in interaction, ease and communication skills and social intelligence as a whole, is based on the capacity for personal influence. V.M. Pogolsha defines this symptom-complex as the basic communicative-personal potential of influence.

I.V. Kuznetsova explored the motive of affiliation (communication) in interpersonal communication. Understanding in interpersonal communication is the basis for the formation of emotional-trusting communication. Lightness, emotional appeal and trust are the qualities that compensate for the unsatisfied need for emotional-trusting relationships. Satisfying the need for emotional-trust communication indicates the ability to establish, maintain and develop interpersonal informal relationships. Excessively high and low demand combined with the lack of communication skills and the existence of psychological defense mechanisms leads to dissatisfaction with existing relationships, and, accordingly, internal personal and interpersonal conflicts.

Considering the problems of understanding and misunderstanding by each other, T.B. Yushachkova concludes that in people’s minds misunderstanding is primarily related to the process of communication, interaction with another person. Misunderstanding is always based on a contradiction, disagreement, lack of unity, rejection, in a word, a certain disharmony in the relationships with another person, which is experienced as a stressful situation, accompanied by negative emotional reactions. Specific cases, actions, statements and, to a lesser extent, the personal characteristics of another person are the subject of misunderstanding, which causes difficulties in relationships. Researches of individual communication style have been associated with the study of problems of professional pedagogical communication in the context of polysystem study of individuality [25], which consider pedagogical communication from the standpoint of interaction of systems of the meta-individual world.

The style of pedagogical communication in the interaction of systems “tutor” and “pupil” acts as a system phenomenon that maintains the dynamic equilibrium of these systems and reflects their positional relations. The style of pedagogical communication has a hierarchical, multicomponent, multilevel structure, represented by different elements of pedagogical communication (purpose, actions, operations). By the form, the style of pedagogical communication can be represented as a manifestation of different forms of activity of the teacher, which are characteristic of pedagogical communication: informative, presentative, perceptive and facilitative.

The peculiarity of these forms of activity is determined by the different functional positions of the interacting systems, the functions of activity in this interaction. The style of pedagogical communication performs various functions in relation to the interacting systems: inter-individual (adaptive, compensatory), intra-individual (system-forming, developing) and meta-individual (attributive).

The process of formation and improvement of the style of pedagogical communication depends on the system of internal and external conditions. The system of internal conditions is represented by the peculiarities of the teacher’s personality (the requirements of the system “tutor”). The system of external conditions is represented by the peculiarities of children communicating with teachers and the conditions of their professional activity, in the context of which communication is taking place, in other words, the requirements of the “child” system and the “society” system.

2. Peculiarities of pedagogical facilitative communication.

The adaptive model of pedagogical communication is aimed at adjusting the situation of interaction to the individual of the tutor and is determined by the attitude to professional activity as a means of achieving personal success. The developing model of style formation is aimed at active manifestation of the teacher's individuality in the process of his or her interaction with children, taking into account their characteristics as active subjects of communication. It is defined by the attitude to professional activity as one’s existence, manifestation of one’s self. The process of teacher’s professional development along with a positive, pedagogically appropriate style can result in a negative, pedagogically inappropriate style of communication. It reflects the positional imbalance of the interacting systems; it is manifested in the priority of the teacher’s position as a system and the child's position as a subsystem; it does not take into account the interests of the child as an active subject of interaction, and affects negatively the child’s development process.

The modernization of national education system consists in the humanization of the educational process, in the transition from the usual traditional-educational system (where the position of teachers and students is formal and the function of the teacher is purely in transferring knowledge), to pedagogy of partnership (where students and teachers are open to communication with each other).

The researches of V.I. Dolgova and O.V. Melnyk are devoted to the empathy and communicative competence of educators, in particular, the model of professional communication competence formation: knowledge of one’s perceptual skills, verbal and non-verbal means of communication, one’s own personal qualities that impede the process of communication, knowledge of one’s own communicative abilities, rules of regulation and means of correction of communicative behavior. It should be noted that in the 2000s the problems of social perception became relevant in the psychology of communication. In particular, the development of motivational components of pedagogical communication and pedagogical activity; social and perceptual standard of personality as a multifunctional determinant of professional pedagogical

activity; social intelligence, within which the implicit models of social development are developed; socio-perceptual aspects of pedagogical conflicts and individual communication styles in professional pedagogical activity and life activity are studied (L.M. Dauksha, K.V. Karpinskii, G.F. Mykhalchenko, L.A. Semchuk). Studies on various aspects of social perception and reflection are conducting nowadays.

As noted by L.M. Dauksha, the most important human needs are the needs for communication, acceptance, recognition and self-expression. It is they that determine the importance of forming a favorable impression of the person, which, of course, is reflected in a person's social success. At the same time, teachers with high social intelligence are characterized by such a strategy of self-presentation as attractive behavior, and a demonstration of strength and status, that is, forceful influence is peculiar for teachers with low social intelligence.

Since the 2000s, the Questionnaire of Formal-Dynamic Properties of Individuality (V.M. Rusalov) has been actively used to determine the communicative features of educators, in particular, its scales: communicative ergonomics, communicative plasticity, communicative speed and communicative emotionality.

One of the researchers of the problems of pedagogical communication is V.A. Kan-Kalik, who regarded it as the most important component of teacher's professional creative activity. He defines professional pedagogical communication as a system of techniques and skills of fundamental socio-psychological interaction between the teacher and the pupils, the content of which is the exchange of information, the organization of educational influences and relationships through various communication means. Communication, according to V.A. Kan-Kalik, acts as a means of solving educational problems; social and psychological support of the educational process; a way of organizing the relationship between the teacher and the students [7].

Communication specified in pedagogical activity acts both as a process of the teacher's solution of many communicative problems and as a result, and it is a professionally creative category. In the process of communication the teacher performs a psychological and communicative search related to the knowledge of the individual identity of another person (the pupil), and accordingly chooses the specific repertoire of educational expedient influences on the individual [5]. Scientists G. Voloshko, O. Galitsan, A. Martynova, O. Fisun treat pedagogical facilitation as an interaction between teacher and student, which ensures the creation of favorable conditions for self-development of participants in the educational process and is based on the principles of humanism, tolerance and polysubjectivity [24; 4; 16; 3]. In particular, such an interaction, from the point of view of O. Galitsan, involves "the search for ways and means of humanization of the educational process" [4].

According to O. Shakhmatov and I. Shunin, pedagogical facilitation is a "two-way process of interaction between the subjects of interaction (teacher and student)", which improves the efficiency of educational process and pedagogical interaction due to the teacher's consideration of the individual characteristics of each student and the chosen optimal communication style [21].

In O. Fisun's research, pedagogical facilitation is seen as the teacher's ability to facilitate, assist, promote and create conditions for self-development, to be aware of his own self-worth and personal growth of students. Thanks to this ability, the teacher can convey the idea to the student that the main result of learning is the skill of intensive and competent search for knowledge. Personal change, not static knowledge, is, according to the scientist, the only issue that makes sense when choosing the purpose of education in the modern world [3].

O. Fisun also defines the conditions of facilitation:

- 1) the problem education;
- 2) deep confidence of the teacher in the students, their abilities;
- 3) respect for students;
- 4) tolerant attitude towards students, understanding their reactions;
- 5) providing students with informational, didactic, logistical resources.

The scientist also believes that the role of the facilitator requires a teacher to have certain skills: to listen carefully, to observe and to remember both the course of events and the style of behavior of students; to establish simple and fruitful communication between the members of the training group; analyze and adjust students' actions; diagnose and encourage effective (correct ineffective) behavior; promote the creation of a model of effective behavior; to provide feedback between participants in the educational process without using "offensive" and "defensive" forms of communication; to find and activate constructive models of behavior in intra-group interaction; to activate similar models in inter-group work; to be trustworthy and patient; to be fair, to choose a neutral position when evaluating work.

E. Skibikitskii and I. Skibikitska define pedagogical facilitation as the technology of management of the process of purposeful learning, which is based on the facilitative communication taking into account the psychological characteristics of "three components of interpersonal communication – communicative, perceptual and interactive". Due to the active interpersonal relationships of the participants of the pedagogical process, such technology provides high-quality and meaningful learning of the educational program and the formation of necessary competences [22].

Researchers S. Romashina and A. Mayer view pedagogical facilitation as the means of managing the development of the subject through facilitation, the mission of education in the formation of the subject, as well as the functional and role repertoire of the teacher and, directly, the trajectory of the student's development. In turn, interaction and communication in the process of joint activity, socio-psychological mechanisms of human perception and "reflection of its activity, mechanisms of self-knowledge and self-development of the individual" are called the sources of the formation of facilitation by scientists [20].

F. Muhametdzianov supports this point of view, noting that the management of the students' activities by the teacher, from the position of an assistant who helps the student to learn new skills and find answers to the questions, is defined by the term "facilitation" in pedagogy [17]. T. Gura considers pedagogical facilitation as a qualitatively progressive method which contributes to improving the level of education of participants in the educational process and responds to modern requests of pedagogical practice. The researcher argues that pedagogical facilitation helps to overcome the traditional approach when students perform only executive function in joint activities due to the transition from "forming a specialist-executant to the preparation of an active, capable of independent analysis and making non-standard decisions specialist-leader" [5].

Thus, there is a large amount of research currently focusing on interpersonal communication of the teacher, acmeological approach to pedagogical communication, motivation of social success in the process of communication and formation of skills of effective pedagogical communication with students whose future profession is psychology. An analysis of contemporary literature on the problem of research shows that in modern education there are different types of facilitation, and each one plays a significant role in the process of self-realization, self-development, at the same time meeting the principles of humanism: psychological facilitation, pedagogical facilitation, social facilitation, eco-facilitation.

Psychological facilitation is the process of managing and simultaneously designing / reconstructing a managed system. Further process is probabilistic, nonlinear and irreversible, which corresponds to the nature of personal change. Psychological facilitation is conditioned by paradoxical control over the process of self-reconstruction and self-organization of an open dynamic personality system. Pedagogical facilitation is a kind of pedagogical activity that helps students to become aware of themselves as a self-worth, supports their desire for self-development, self-realization, self-improvement, promotes personal growth, disclosure of abilities, cognitive opportunities, actualizes value attitude to people, nature, national culture on the basis of organization of humanistic, dialogical, subject-subject communication, an atmosphere of unconditional acceptance, understanding and trust. Social facilitation is aimed at increasing the speed or productivity of an individual's activity as a result of the actualization (perception, presentation) in his mind of the image of another person (or group of people), acting as a rival or observer of the actions of that individual. Eco-facilitation is the process of managing an open dynamic personality system in order to maintain it in a state of self-development. In eco-facilitation the principle of profitability means that the educational space has already all the possibilities for successful self-development of the individual and creation of an individual competitive model of his own professional growth.

Thus, the facilitation position of the future psychologist is such a system of attitudes, motives, values of a person, where the principles of a positive attitude, respect for dignity and mind of the person, belief in the ability of the person to approve decisions independently become decisive in the status and role structure.

The formation of the facilitation position of the future psychologist is influenced by both internal psychological and external psychological and pedagogical conditions. Internal conditions include: a developed hierarchy of vital values and spiritual values; positive openness and acceptance of people; tolerance for the opinions of others, different from one's own, and tolerance for uncertainty; understanding the interconnections and interactions of people; careful attitude to any special manifestations of personality; openness to knowledge and constant personal growth; reflectivity; awareness of one's own psychological defense mechanisms; self-esteem and self-acceptance, personal maturity, congruence; personal freedom and responsibility; the ability to respond quickly to a changed situation; absence of negative stereotyping; observability and understanding of non-verbal language. These characteristics form a complex system of interconnected components that determines the facilitation position of future psychologists. The external psychological and pedagogical conditions of the formation of the facilitative position include the facilitation technology, which is used in the educational environment by the teacher-facilitator, the facilitative competence.

The formation of the facilitation position of the future psychologist in the educational environment occurs in the process of facilitation interaction, where the facilitator demonstrates the facilitation position: examines the psychological and pedagogical problems that arise in the learning process in the context of the variability of solving problems; emphasizes the possibility of positive changes in the professional activity of the future psychologist in the learning process; focuses on the inner personal potential of the future psychologist; integrates into the educational space all the reasons, events, life situations presented by future psychologists; demonstrates methodical skills, applies facilitation technologies in the process of training future psychologists; demonstrates facilitative competence by interacting with future psychologists; pays attention to the personal

subjective experience of future psychologists, using their personal experience as a source for resolving problematic issues; relies on positive motivation and situation of success as necessary components of facilitation interaction of participants of educational process; focuses on interactive communication with participants of the educational process; reveals inner mobilization and readiness of each future psychologist for self-development, self-realization, self-improvement [1].

Thus, the formation of the facilitation position of future psychologists in the system of higher education means gaining practical experience of facilitation interaction, where the instructor-facilitator creates the conditions for the professional formation of future psychologists, their self-development and self-improvement, and showing facilitation position enables future psychologists to gain positive experience from this position, compare the position of the teacher facilitator and traditional teacher with the dominant one.

Conclusions.

The analysis of the process of developing effective pedagogical communication allows distinguishing and substantiating the following factors: creative interaction of subjects of the educational process; a set of psychological and pedagogical tools for involving students in creative pedagogical activity; dialogue communication between teachers and students in the process of their professional training. It should be emphasized that these factors do not work in isolation from each other, but being interconnected, they act as a whole – as a system.

Creative interaction is a complex of relationships and interactions of the subjects of the pedagogical process, which internally initiates the mechanisms of forming pedagogical communication of the future psychologist, deepening such an important personal quality as reflexivity, enhancing the student's ability to develop his or her own productivity. The teacher should be able to create situations that can awaken students' lively thoughts. In the process of communication through the mechanisms of creative interaction the person is taken to another level of reflection and self-cognition, turning the external dialogue into an internal one, which deepens the processes of meaningful self-cognition.

The set of psychological and pedagogical tools for students' involvement in creative pedagogical activity is the basis of the dialogue communication between teachers and students in the course of their professional training, which covers methods and forms of organization of training in higher educational establishments, pedagogical practice, forms of scientific cooperation, research activities. It is these techniques and means that stimulate and activate the professional development of future psychologists. Hence, there are three conditions for the formation of pedagogical communication: deep and conscious students' knowledge of the subjects of psychological-pedagogical block; creating an atmosphere of trusting dialogue between cultures in the process of professional training; design and implementation in practice of humanistic model of pedagogical communication.

Psychology of communication is closely linked to the leading tendencies of the philosophy of education; in particular, education is now interpreted as a permanent "completion" of the individual's position in accordance with the social and cultural context in the broad sense, constant inclusion in the social and cultural field. In this case, the social conditionality of education indicates the presence of some forces that legitimize its effectiveness. On the other hand, education is focused on stimulating the "personal growth" (self-development), on the development of the inner (creative) potential of the individual, his personality.

The problem of education in this context is related to the combination of three strategies: the reproduction of social structure through the training of professionals, the education of subjects of culture and the formation of a unique, creative, independent and free personality. In turn, the problem of educational and pedagogical discourse is expressed in the search and implementation of adequate cognitive and communicative means that represent the professional, cultural, existential ideals of education and construct professional, socio-cultural and personal identities.

Thus, the peculiarities of the formation of the facilitation position of the future psychologist are in combining the internal psychological and external psychological and pedagogical conditions. Internal conditions include a humanistic system of value orientations (where a person is of higher value), the formation and development of personal qualities. External psychological and pedagogical conditions for the formation of the facilitator position are provided by the facilitative technology and the competence of the instructor-facilitator.

Facilitative technology contains the principles of activity of the teacher-facilitator and ways of their realization in educational interaction, and his facilitative competence includes motivational, cognitive, operational-activity and reflexive competence, which are components of the facilitation position of the teacher and then (in the process of gaining experience and knowledge of facilitation interaction in the educational environment) of future psychologists. Compliance with these conditions in the process of training future psychologists will help them to develop a facilitative position, which is important in their formation as future specialists.

References

1. Avdyeyeva, I. M. (2009). Facilitative pedagogical interaction and short-term positive psychotherapy: common approaches. *Aktualni problemi psihologii*, 19 (Vol. 7), 5-12 [in Ukrainian].
2. Bodalev, A. A. (1995). *Personality and communication: selected psychological works*. Moscow: Mezhdunarodnaya pedagogicheskaya akademiya [in Russian].
3. Fisun, O. V. (2010). Pedagogical facilitation as a multifaceted phenomenon. Means of educational and research work: a collection of scientific works of Kharkiv National Pedagogical University named after G. Skovoroda, 34, 133-139.
4. Halitsan, O. A. (2012). Theoretical basis of the problem of applying principles of pedagogical facilitation in professional activity of a teacher of a modern school. *Naukovyy chasopys Natsionalnoho Pedagogicheskoho Universytetu im. M.P. Drahomanova. Seriya 16: Tvorchyia osobysti vchytelya: problemy teorii i praktyky*, 18 (28), 129-132 [in Ukrainian].
5. Hura, T. V. (2014). Pedagogical facilitation – a mechanism for developing students' leadership potential in a technical university. *Teoriya i praktyka upravlinnya sotsialnyimi systemamy: filozofiya, psihologhiya, pedagogika, sotsiologhiya*, 3, 32-44 [in Ukrainian].
6. Kan-Kalik, V. A. (1987). To the teacher about pedagogical communication: teacher's book. Moscow: Prosveshcheniye [in Russian].
7. Kan-Kalik, V. A., & Kovalev, A. G. (1987). Classification of psychological types of communication. *Voprosy psikhologii*, 3, 23-28 [in Russian].
8. Kazanzhy, M. Y. (2015). Facilitation in the preparation of socio-economic specialists. *Visnyk Odeskoho natsionalnoho universytetu im. I. I. Mechnykova. Psihologhiya*, 3 (37), Vol. 20, Part I, 31-42 [in Ukrainian].

9. Khilko, S. O. (2014). A Facilitative Approach to the Professional Training of Future Psychologists. *Psykholoho-pedahohichne zabezpechennya modernizatsiyi pislyadyplomnoyi pedahohichnoyi osvity v umovakh zmin: Vseukrayins'koyi naukovo-praktychnoyi internet-konferentsiyi*. Kyiv, Donetsk: Universytet menedzhmentu osvity. Retrieved from: <http://umo.edu.ua//Sekciya3.pdf> [in Ukrainian].
10. Kozlov, V. V. (2007). *Integrative Psychology: Ways of Spiritual Search, or Sanctification of Everyday Life*. Moscow: Psikhoterapiya [in Russian].
11. Kunitsyna, V.N., Kazarinova, N. V., & Pogolsha, V. M. (2001). *Interpersonal communication. Textbook for high schools*. St.-Petersburgh: Piter [in Russian].
12. Kuzminsky, A. I., & Omelyanenko, S. V. (2010). Technology and technique of a school lesson: textbook. Kyiv: Znannya [in Ukrainian].
13. Leontyev, A. A. (2008). *Psychology of communication: a textbook for students of higher educational institutions*. (5th ed., rev). Moscow: «Akademiya» [in Russian].
14. Leontyev, A. N. (1979). *Pedagogical communication*. Moscow: Znaniye [in Russian].
15. Lushin, P. V. (2005). *Personal changes as a process: theory and practice: monograph*. Odesa: Aspekt [in Russian].
16. Martynova, A. V. (2011). Facilitation as a technology of organizational development and change. *Organizatsionnaya psikhologiya*, 2, Vol. 1, 53-91. [in Russian].
17. Mukhametzyanova, F. G., & Khayrutdinov, R. R. (2017). On the phenomenon of facilitation in higher education. *Kazanskiy vestnik molodykh uchenykh. Pedagogicheskiye nauki*, 2 (2), Vol. 1. C. 9-10 [in Russian].
18. Petrovskaya, L. A. (1977). On the conceptual framework of a socio-psychological analysis of conflict. *Teoreticheskiye i metodologicheskiye problemy sotsial'noy psikhologii*, 126-134. G. M. Andreeva (Ed.). Moscow: Moskovskiy gumanitarnyy universitet [in Russian].
19. Petrovsky, A. V., & Yaroshevsky, M. G. (Eds.) (1990). *Psychological dictionary*. (2nd ed., rev). Moscow: Politizdat [in Russian].
20. Romashina, S. Ya., & Mayer, A. A. (2012). Facilitative pedagogy in higher education. *Professionalnoye obrazovaniye v Rossii i za rubezhom*, 2 (6), 42-49. Kemerovo: Kuzbasskiy regionalnyy institut razvitiya professionalnogo obrazovaniya [in Russian].
21. Shakhmatova, O.N. (2006). Pedagogical facilitation: features of formation and development. *Professional'noye obrazovaniye*, 3, 118-126 [in Russian].
22. Skibitsky, E. G., Skibitskaya, I. Yu. (2017). The use of pedagogical facilitation in the preparation of masters in an educational organization. *Sibirskaya finansovaya shkola*, 5, 90-94 [in Russian].
23. Volkova, N. P., & Stepanova, A. A. (2018). Facilitator as an important role position of the modern university teacher. *Visnyk universytetu imeni Alfreda Nobelya. Pedahohichni nauky. Seriya «Pedahohika i psikhologhiya»*, 1 (15), 228-234 [in Ukrainian].
24. Voloshko, H. V. (2016). Facilitative approach in the activity of the teacher as a modern direction of higher education reform. *Pedahohichni nauky: teoriya, istoriya, innovatsiyi tekhnolohiyi*, 9 (63), 96-106 [in Ukrainian].
25. Vyatkin, B. A. (1999). *Integral individuality of a person and its development*. Moscow: IP RAN [in Russian].

Tetiana Yu. Dudka

Doctor of Pedagogic Sciences, Associate Professor. Professor of the Department of Management and Innovative Technologies, Social and Cultural Activities, National Pedagogical Dragomanov University, Kyiv, Ukraine

Mykola Ye. Chumak

Doctor of Pedagogic Sciences, Associate Professor, Head of the Department of Theories and Methods of Teaching Physics and Astronomy, National Pedagogical Dragomanov University Kyiv, Ukraine

Iryna S. Markus

Senior Lecturer of the Department of Theory and Methods of Technological Education, Drawing and Computer Graphics, National Pedagogical Dragomanov University Kyiv, Ukraine

PEDAGOGICAL FUNDAMENTALS OF THE RESEARCH OF KNOWLEDGE MANAGEMENT DEVELOPMENT IN HIGHER EDUCATION

***Abstract.** The research presents the fundamentals of the impact of the personality-centered vector on knowledge management development in higher education. In the course of theoretical generalization, the author's definition of the concept of "knowledge management" is formulated and its expositional orientation on meeting market needs of highly skilled personnel is emphasized. Knowledge management development at the personal level in terms of implicit, disjunctive, and conjunctive approaches are problematized. The effects of using advanced information technologies and teaching aids in the educational process of higher education, which deepen knowledge management development at the inter-sectoral level are emphasized. The importance of conducting an institutional audit of educational establishments is generalized, which allows identifying the level of compliance of the quality of knowledge management development with the requirements of current standards. The system-forming structure of the institutional audit of educational activity is presented, which represents the competitiveness of the functioning of the diagnosed study program according to the researched criteria. The necessity of a comprehensive analysis of the issue of knowledge management development to identify the level of their development to the demands of current social progress is summarized.*

Introduction.

In terms of global development, the pedagogical community has come to realize the need for practical modeling of innovative approaches focused on the development of the general cultural and intellectual potential of subjects of knowledge. In this regard, the problem of developing effective approaches to knowledge management development, aimed at the implementation of the main applied tasks of education. However, today, the issue of slow implementation of the above-mentioned approaches in the educational process of professional training remains problematic. At this time, on the political map of the world, countries are competing for the most qualified professionals, which actualizes the study outlined in this paper.

The content of the legal act «Europe 2020: A European strategy for smart, sustainable and inclusive growth» emphasizes the fact that the number of competitive professionals with higher education in the modern European labor market should be at least 40% of the total number of graduates who must freely manage their knowledge [1].

In order to ensure the proper innovative development of the pan-European landscape, the budget of the European Union provides for the investment of the research and implementation of information technology in the equivalent of 3% of the total GDP of the united countries.

Many scientists have studied the issue of knowledge management in the structure of professional training in higher education [2-4]. Given the diversity of scientific views on certain topics, three key areas of research have been clearly outlined, which are presented in terms of the following components: meaningful (why teach?), structural (in what sequence?), and technological (in what way?).

Without going into the details of the author's approaches to the content of educational technologies, which actualize the pedagogical problem of knowledge management of the subjects of cognition, two main groups of scientific approaches to justify a certain category were identified: a set of the most advanced approaches to learning and establishing highly effective communication.

Theoretical and methodological aspects of justification of the significance of knowledge management by a future specialist

From a theoretical point of view, the category of «knowledge management» is quite multifaceted, due to the complex nature of the integrity of its internal structure. The long way of comprehension by a person of the art of knowledge management crosses borders of the formation of: 1) the acquired knowledge, formed abilities and skills; 2) value orientations; 3) professional competence. In addition, the successful mastery of the art of knowledge management opens to the individual the door to a world of perfect professional culture, the top of which seeks to reach every subject of cognition.

We define the concept of «knowledge management» as the integration unity of personal qualities that provide a systematic dynamic exchange of information, through professional competence and experience.

As modern processes of globalization and informatization of society have updated the formulation of new requirements for professional training in higher education, the problem of knowledge management has acquired a new pedagogical meaning. Largely, this applies to the training of future professionals; the key to the success of their professional activities is the ability to use their own knowledge in typical and atypical situations.

In modern Ukraine, the problem of seeking modern specialists with the functional potential of an analyst, practitioner-organizer, and manager remains unsolved. Specialists of this level who consider the practical side of their own knowledge management the norm of everyday life can meet such social demands.

The argumentation of the above-quoted position is evidenced by the content of the term «highly qualified specialist», which states that he must «... have special training and possess the knowledge in a wide range of fields, including economics, business, social psychology, etc.» [2, p. 80]. This quote prompts the idea that the practical projection of professional manifestation of the individual's ability to manage his own knowledge is based on deep interdisciplinarity, which involves the knowledge components from different fields.

The art of managing one's knowledge for a future specialist is the key to further professional success. The effectiveness of this pattern is partially reflected in the personal understanding of the mechanisms of self-organization of society and its units, the effectiveness of cooperation of available labor resources, which are aimed at achieving the appropriate level of social performance.

Thus, a future specialist faces an extremely difficult professional task – to learn to professionally manage his knowledge in a harsh competitive environment of the market system of relations.

To implement the above-mentioned professional tasks, according to David Skyrme, future professionals must possess the ability to innovate, constructive thinking, rich imagination, and skills to create original projects and teach subordinates [5].

Following the ideological integrity of the positions of this Western scientist, it becomes clear that a sufficiently reasoned approach to the organization of knowledge management development is a creative philosophy of work, which would guide potential managers and their subordinates to approach tasks in a creative way, take justified risks, and perform entrepreneurship [4, p. 52]. Achieving such a result by the future specialist is possible due to the availability of a high level of education and intelligence, as well as the ability to operate in the rapidly changing modern conditions.

The lack of modern market-oriented education and personal experience in the knowledge management seriously hinders the development of the country's competitiveness on the world arena. The usual course of study in specialized higher educational establishments and short training in schools of marketing, management, and business are not able to solve these problems. First, special attention should be paid to the profound gradual educational training of young specialists in educational establishments of various forms of ownership. This approach, in turn, will allow improving the quality of education in the state in the shortest possible time without additional burden on the state budget.

In the projection of the national strategy for the knowledge management development, the task of training and additional training of available specialists and managers is actualized. Such actions are taken due to the consequent effectiveness of the impact on society made by the current economic realities of the transition type, which once again confirms the unwillingness of the available personnel to confidently «take charge» of this complex process.

Professional training of future specialists under modern conditions is conditioned by the need to clarify the qualitative characteristics of the specialist; the availability of a model of his training in the context of educational activities of the educational establishment provided that appropriate pedagogical conditions are created for the successful training of a specialist in this field. It is worth noting that the effectiveness of each task directly depends on the level of knowledge management development at the personal, as well as social levels in general.

An urgent requirement of modern society is the formation of a professionally competent person able to adapt to the changing modern conditions. Under the market conditions, the young generation is faced with increasingly progressive requirements for prompt management of their knowledge. In this context, the issue of creating optimal organizational and pedagogical conditions for the formation of a competitive specialist able to properly present his homeland in the international arena becomes especially relevant.

Under such extraordinary conditions of social and cultural life, the identifier of the level of the knowledge management development at the personal level is the indicator of competitiveness [2; 4; 5; 6]. Likening these two interrelated concepts, the researchers concluded that their versatility quite reasonably reveals the fullness of the three fundamental approaches:

1) implicit – targeted definition of the integrity of the hierarchical construct «personality – enterprise – state», where each link is interconditioned and interdependent (in particular, the

competitiveness of the state directly depends on the level of competitiveness of an enterprise and an individual and vice versa) [6];

2) disjunctive – focused on determining the set of features, peculiarities, and characteristics, which identification and analysis gives us a detailed description of the image of a competitive specialist [6-7];

3) conjunctive – aimed at reflecting competitiveness as «... an integral characteristic inherent in an active person able to effectively manage knowledge under specific conditions of professional activity» [7].

Analyzing the content of the above-mentioned approaches, we would like to emphasize that the conjunctive approach is certainly the most relevant to the issue of knowledge management. Especially valuable is the possibility of involving the provisions of the latter approach in the process of training a competitive specialist in the educational and professional space of higher education. However, the implementation of this task is quite complex and multifaceted, which involves the creation of special pedagogical conditions.

In terms of the studied problems, we refer to external sources actualizing the knowledge management development at the personal level as specially organized pedagogical conditions (first of all, the designed educational and professional space of a higher educational establishment), which promote the formation of such personal qualities influencing the formation of the students' competitiveness. Internal sources include the endogenous potential of an individual (biological organization of man, the activity in the process, the need for self-development and self-actualization, the level of physical health, etc.).

The analysis of foreign publications confirmed the ideological unity of modern approaches to the possibilities of knowledge management development at the personal level, which is actualized by the cumulative influence:

- means (technologies, forms, methods, techniques, etc.) of the pedagogical process organization;
- conditions (organizational, psychological, pedagogical, personal, activity, and others) of the pedagogical process implementation;
- factors (strategic, tactical, interaction factor, etc.) that contribute to or hinder the achievement of the outlined goals [7-9].

Thus, the orientation of the educational process on the deepening of skills and abilities of the subjects of cognition to manage their own knowledge in typical and atypical situations makes the formation of a highly qualified specialist of the relevant profile problematic. The level of competence of such a specialist, in particular, will confirm the personal focus on cooperation with specialists in related fields; readiness to work effectively within the specialty, according to the requirements of world standards; focus on the professional growth and life-long education for self-improvement.

Considering such extensive multilevel tasks of the educational process, in particular, aimed at the acquisition of knowledge management skills by the subject of cognition, the need to involve a competency-based approach to the implementation of the planned one. The prognostic model of the average graduate is represented by general cultural and professional competencies, which are the basis of the study program in this area and the appropriate level of training.

Competence approach is distinguished among others by its targeted effectiveness, which allows ensuring the guaranteed quality of training of future professionals, including the

development of skills and abilities of knowledge management. Such a wide semantic field of the essential content of the phenomenon of the «competence approach» significantly complicates its interdisciplinary dimensions and emphasizes the projectivity of the quality of learning outcomes for social progress. Taking into account such social and cultural significance of the competency approach for establishing the value of knowledge management development in the international educational space, draws the attention of the public to the formation of a single and integral treasury of global knowledge, distinguished by its cosmopolitan status.

Studying the level of orientation of the competence approach to the satisfaction of existing public demands for knowledge management development within the existing educational space, the significance of competencies related to the subject of life activity; human interaction with society; human activity in all its manifestations and forms. All of them are a certain internal, potential, psychological neoplasm, which semantic basis is knowledge. The art of knowledge management on a personal level is represented by a whole algorithm of actions, a system of values and relations reflected in human competencies.

In a post-industrial society, knowledge itself becomes the driving force of social progress, due to its subject and information centering. These positions point to the conflict between what modern society needs from the future specialist and what the available reproductive and industrial model of education prepares for him.

Nowadays, objective conditions of civilization development require educational establishments to reorient educational training to professional knowledge management development. Representatives of all industries without exception value the high level of professionalism reflected in the quality of knowledge management.

Perfect forms of human knowledge are the basis of global progress, especially in a market economy and fierce competition between people and ideas. The knowledge potential of human capital, multiplied in modern educational conditions, is now becoming a potential element of national wealth. However, many countries are not focused on the transition to the quality knowledge management, which creates a number of social contradictions and uneven socio and economic development of states. To overcome these consequential effects, it is necessary to move away from the outdated assertion that economic development depends only on the growth of quantitative indicators, which are not always identified with the requirements for the concept of «quality».

Thus, the transition of inferences will consequently lead to the understanding that the narrow specialization of practice-oriented education is one-sided and does not meet the existing requirements of social and economic growth. Overcoming such one-sided synchronicity should be directed at a clear educational focus on knowledge management development by attracting all the necessary resources to actualize individual and group growth.

The social requirements facing the future professional include the formulation of new approaches to knowledge management development to solve and mature pedagogical tasks. A special priority under such conditions is given to the so-called comprehensive development of personality, aimed, in particular, at the formation of creative thinking at all stages of life. The priority tasks of the current activity of a creative personality are the need for systematic updating of knowledge and knowledge management in different situations.

The operational efficiency of the future specialist's knowledge management partially testifies to the effectiveness of his future performance of diagnostic and expert functions in places

for which social responsibility is provided in case of mistakes and miscalculations. In this regard, the business customers of the modern labor market are most interested in the professionals able to strategic miscalculations and innovation freely implementing their knowledge management.

Focusing on the need to manage their knowledge, future professionals should not forget about the importance of:

- understanding the significance of their professional activity as an integrative process in which analysis and synthesis are supported by the perception of social needs;
- analytical skills to deeply and objectively assess the situation, based on quantitative and qualitative assessment parameters;
- the ability to realize the significance of current problems and the ability to model the situation based on their knowledge in the field of basic natural sciences and humanities;
- the ability to design resource potential, based on the current needs for further development;
- contextual understanding of the situation based on the current conditions in which the activity takes place;
- the readiness to replenish the «arsenal» of their knowledge throughout their working activity, thus adapting to changes in the technological sphere and to social requirements.

In the course of generalizations of theoretical substantiations of the importance of knowledge management by the future specialist, it becomes clear that we are dealing with a quite serious social and cultural task. The implementation of the latter at the interpersonal level is associated with the ability to communicate freely, the ability to show individuality, the willingness to accept innovation, a creative approach to any professional activity, the flexibility of thinking, and the ability to understand the interests and aspirations of the interlocutor properly.

Modern approaches to knowledge management development of future specialists are focused on the presentation of personality as a central figure, which involves creating optimal conditions for its further growth and opportunities to adapt to current life situations.

Practical aspects of knowledge management in higher education by means of audit tools

The vector direction of modern educational policy makes us think «whether the activity of Ukrainian higher educational establishments meets the market requirements of the XXI century?» The principles of democracy and humanism, transparency, and openness, which determine the development of the world community according to a certain logarithm of social and cultural existence, do not lose their popularity in the circulation of the international educational community. In this sense, the multifaceted concept of «the quality of knowledge management» is fundamental in understanding the effectiveness of the mechanism for managing the development of educational establishments.

The availability of certain contradictions between the current level of educational training and the needs of the market has actualized the revision and adjustment of the forms and methods of national control over the quality of educational activities. The smooth transition of sectoral state control from the diagnosis of the continuity of educational services to the systematic monitoring of the quality of knowledge management in higher education has raised many questions within the concerned pedagogical community. The unusual format of accreditation procedure, temporary suspension of licensing – these are the consequences of educational reform met by Ukrainian universities on the threshold of a difficult period of twenty years. Of course, the reform is a product of recent historical development, and therefore adaptation to new realities is the key to the further successful operation of the industry in space and time.

In response to the effectiveness of educational reform in highly developed countries and in the pro-Ukrainian territory, the need to create optimal conditions for more objective and transparent assessment of the quality of knowledge management and as a consequence – the quality of educational activities in general. Such a procedure in national circulation is called an institutional audit of educational establishments. The values of this process in the social and cultural aspects are partially reflected in the fundamental purpose of the activity, content, procedural completeness, and other aspects of the effectiveness of diagnostic activities.

Today, the relevance of the studied issues is beyond doubt, because the full understanding of practical principles of the mechanism of the institutional audit of educational establishments is partially hidden at the level of thematic and theoretical discourses. The latter allows us to rethink the problem at the interdisciplinary level, to avoid mistaken judgments and superficial generalizations based on the analysis of selective facts of current events.

Today's democratic challenges are forcing us to rethink the issue of partial compliance of the level of development of knowledge management of the available social state institutions with the requirements of the highly educated world community. The Eurocentric vector of modern state-building orients us to support such transformations that open the door to the future to achieve innovative and sustainable development of each region.

In these terms, the strategic orientation of the state sectoral policy is gradually modernized by branching out the evaluation scale of the quality of education, based on a number of effective principles of social and cultural reform (including transparency, openness, independence, and publicity). An important activity in this aspect is the assessment of the quality of knowledge management at the level of higher education, which involves expert commissions in the phased discussion of what is seen and analyzed within workshops and meetings. A certain range of powers is vested in the National Agency for Higher Education Quality Assurance and the State Education Quality Service of Ukraine, whose main activity is to conduct an institutional audit of educational establishments to identify their compliance (including the criterion of «quality of knowledge management»). To use the key term of the study correctly and reasonably, it should be detailed that the institutional audit of educational establishments is the verification of data on the compliance of educational activities directed at the implementation of study programs to the current industry legislation. Thus, the profile institutional audit is designed to identify the level of compliance with the quality of knowledge management development at the level of educational activities of higher education, which in the final performance actualizes the identification of its social and economic efficiency for society as a whole. The latter emphasis was made by us not by chance, given the expositional orientation of education to meet public and state needs with highly qualified personnel, aimed at continuous intellectual, professional, and cultural self-improvement.

In search of arguments that actualize the development of institutional audit of educational establishments at the national level, it is necessary to consider the consequent axiological principles of their operation, which will bring us closer to the understanding of its significance for the future knowledge management development at the higher education level (see Fig. 1).

Since one of the key tasks of the structures specializing in the institutional audit of educational establishments is to check the quality of the level of the knowledge management development and educational activities in general, it is worth focusing on the analysis of key categories of the research.

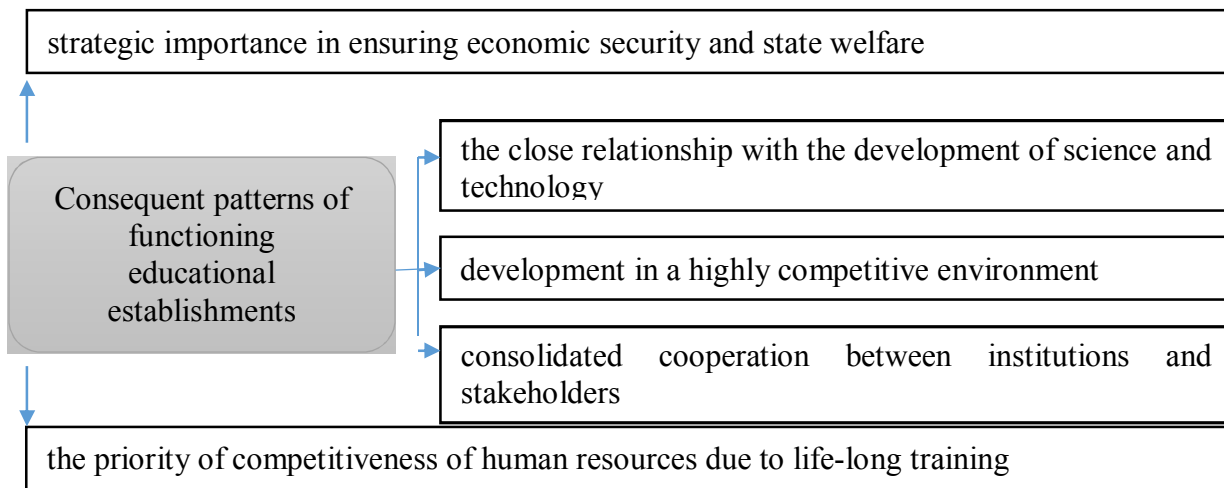

Figure 1. Consequent principles of functioning of higher school in term of perspective knowledge management development

In modern science, the concept of «quality» has a wide range of phenomenological justification, represented by the relevant visual material (see table 1).

To structure the essential substantiations given in the table, we see it expedient to unite their group on a priority phenomenological basis, which correlates the concept of «quality of knowledge management» development with current norms and standards, certain parameters of educational performance, and opportunities to meet current demands (Table 1).

Table 1. Substantiation of the essence of the categories of «quality» and «quality of educational activities» in the scientific research of the XXI centuries [10-18]

<i>Generalized substantiation of categories:</i>	<i>Author</i>
«QUALITY»	
✓ the degree of compliance with current needs, requests and requirements	Abdullah F.
✓ total quality indicator of conditions and functioning process (level of HR, material and technical equipment, etc.)	Akhlaghi E., Amini S., Akhlaghi H.
✓ a set of valuable consumer qualities that form the basis of certification and standardization	Madani R.
«QUALITY OF KNOWLEDGE MANAGEMENT DEVELOPMENT»	
✓ an indicator of compliance of the achieved goals of education with the current standards and norms	Strielkowski W., Kiseleva L., Popova E.
✓ an indicator of social effects of education in terms of current requirements and public expectations	Moosavi A., Mohseni M., Ziaiiifar H., Azami-Aghdash S., Gharasi M., Rezapour A.
✓ the potential of achieved educational goals	Faganel A.
✓ the degree of compliance of the goals and results of the educational process with the general parameters of educational performance evaluation	Prentice G., Brady J., McLaughlin C.

As part of the practical implementation of institutional audit, aimed at identifying the quality of knowledge management and the quality of educational activities in general, identified the appropriate system-forming three-stage structure – the audited entity, the content of audit procedures, quality indicators, the internal audit (self-assessment), the external independent evaluation (see Fig. 2).

Among the listed system-forming components, special attention is paid to indicators of the quality of the educational activity. The list includes, in particular, the level of compliance of the educational program with the norms of current standards and the requirements of stakeholders; the efficiency of the management system; the resource provision (in particular, personnel, information, logistical, scientific and methodological); the correlation of the available indicators to the needs of social institutions (Fig. 2).

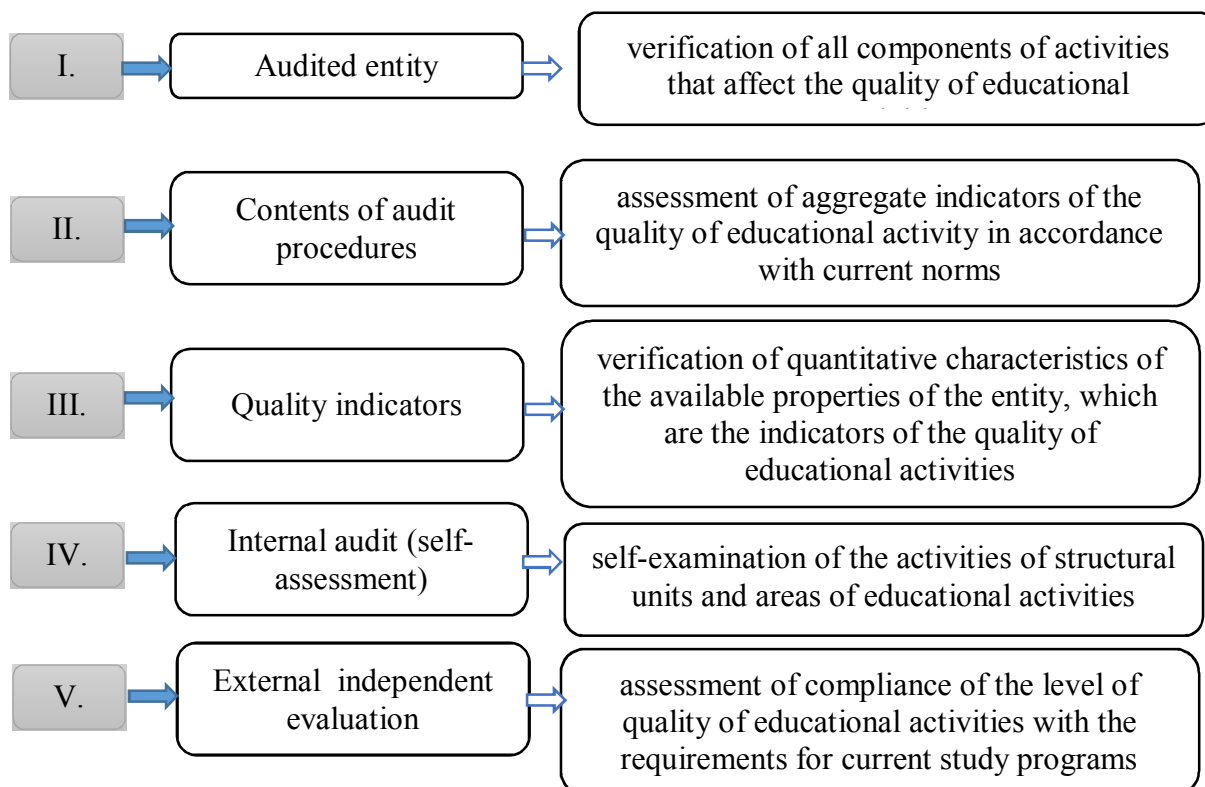

Fig. 2. System-forming structure of institutional audit of educational activity

When conducting an internal audit (self-assessment), the teaching staff is charged with conducting an internal examination of the current achievements in the quality of knowledge management development (Fig. 2). At this stage, the positions of subjects of cognition, who to some extent participate in the internal audit as experts, should be taken into account.

From a practical point of view, external independent evaluation aims to provide a fair assessment of the quality of services provided within a specific study program (Fig. 2). To optimize this process, appropriate conditions are created for conducting an independent institutional audit, the necessary tools (forms, methods, means) are involved, which in total enable the achievement of the set diagnostic goals.

The highly ideological conduct of the institutional audit of educational establishments is hidden in a kind of transmission of values between the participants in this diagnostic process. A closed “chain” of five fundamental concepts triggers the “mechanism” of transmission.

The concepts are representatives of social institutions, relevant government agencies, the education system, stakeholders, and subjects of cognition.

Representatives of social institutions at the indicative level represent monitoring sections of the level of transparency and success of the diagnosed study program. Due to the identification of the expected values from the implementation of the study program among the representatives of social institutions, in future it is possible to make the desired come true.

In the institutional audit, the role of specialized government agencies with experience in management in the industry is not secondary. In audit conditions, government agencies perform a representative function, i.e. represent the interests of the state, monitoring compliance with applicable regulations (including the level of knowledge management development). Their conclusions, based on the results of the audit are presented in the relevant decisions, which are subject to unimpeded implementation.

The institutional audit is carried out with the participation of representatives of the education system, who are high-level industry professionals systematically undergoing corporate training within the current training program.

Quite an important function in assessing the quality of educational activities is performed by expert commissions, which focus on the formulation of reasoned conclusions after the audit and the form of substantiated conclusions. The effectiveness of the audit procedure is reflected in the quantitative parameters corresponding to the four-level rating scale (A, B, E, and F).

To bring the study program closer to the needs of the market, the position of stakeholders who are interested in high-quality training, raising the level of inter-corporate culture in bilateral cooperation “an educational establishment – enterprise, institution, organization” is very important. This format of cooperation sets the appropriate pace of knowledge management development in higher education in the country.

The above-provided ideology shows that a kind of cyclical transmission of values in the institutional audit is provided through the multilateral cooperation of all participants in this diagnostic process. In the course of such cooperation, a list of values that are a priority for various parties to this intra-industrial cooperation is identified. Together, these guidelines form an outline of the quality of educational activities, which must meet the requirements of the parties involved in achieving the strategic goals of knowledge management.

However, the concept of «quality of knowledge management development» is variable, and therefore, today, the objectivity of testing the available list of criteria is a very important task on the way to achieving the desired performance.

Conclusions.

Based on the theoretical analysis, we can conclude that the study of knowledge management development in higher education is quite complex and multifaceted. With this in mind, we have analyzed the theoretical and practical facet of the problem. In the course of theoretical generalizations, we concluded that the knowledge management development at the personal level is the integrative unity of personal skills that provide systematic dynamic information exchange through professional competence and experience. A separate aspect highlights the close relationship between knowledge management development at a personal level with the competitiveness of the specialist. The argumentation of the latter thesis was confirmed by the fundamentality of three scientific approaches – implicit, disjunctive, and conjunctive. In pedagogical terms, it is emphasized that the development of personal skills to manage their knowledge is actualized by the combined

influence of resources (technologies, forms, methods, techniques, etc.) of the organization of the pedagogical process; conditions (organizational, psychological, pedagogical, personal, activity, and others) of implementation of the pedagogical process; factors (strategic, tactical, interaction factor, etc.) that contribute to the implementation of the outlined goals.

The results of the definitive analysis of the categories «quality» and «quality of knowledge management development» in domestic and foreign research are presented.

Summarizing practical aspects of the research, the author emphasizes that the tool for diagnosing the existing indicator of the quality of knowledge management in higher education is an institutional audit. Emphasis is placed on the transmission of values, as an effective pattern of circulation of the modern institutional audit of higher education in order to deepen the level of knowledge management development at the modern stage of social progress.

References

1. Europe 2020: A European strategy for smart, sustainable and inclusive growth. *European commission*. Brussels, 2010. URL: <https://ec.europa.eu/eu2020/pdf>
2. Chibuzor, A., Jovita, O., & Onyemachi U. (2019). Knowledge management and organizational innovation. *Journal of Business and Social Science*, 2(2). 1–19.
3. Salerno, M. (2019). Top Five Tips for A Successful Knowledge Transfer in Times of Chaos, Crisis, or Rapid Change. *Knowledge Management*. 3(1). 11–23. URL: <https://enterprise-knowledge.com/tag/knowledge-management/>.
4. Ngoc-Tan, N., & Gregar, A. (2018). Impacts of Knowledge Management on Innovation in Higher Education Institutions: An Empirical Evidence from Vietnam. *Economics and Sociology*, 11(3). 301–320. URL: https://www.economics-sociology.eu/files/18_637_Tgoc-Tan.pdf.
5. Skyrme, D. (2015). The Seven Ages of Information & Knowledge Management: What Have We (Not) Learned? *Gurteen Knowledge Log*. URL: <http://www.skyrme.com/kmarticles/7ikm.pdf>.
6. Esmaelinezhad, O. & Afrazeh A. (2018). Linking personality traits and individuals' knowledge management behavior. *Aslib Journal of Information Management*. URL: https://www.researchgate.net/publication/325227784_Linking_personality_traits_and_individuals'_knowledge_management_behavior.
7. Chu, M., Kumar, P., Kumar, K., & Khosla R. (2014). Mapping knowledge sharing traits to business strategy in knowledge based organisation. *Journal of Intelligent Manufacturing*. 25. 55–65. URL: <https://link.springer.com/article/10.1007/s10845-012-0674-1>.
8. Ilhan, Y., & Oruc, S. (2016). Effect of the use of multimedia on students' performance: A case study of social studies class. *Academic Journal Educational Research and Reviews*, 11(8). 877–882. URL: <http://www.academicjournals.org/journal/ERR/article-full-text-pdf/5047F0A58349>.
9. Razmerita, L., Kirchner, K., & Sudzina, F. (2009). Personal Knowledge Management: The Role of Web 2.0 Tools for Managing Knowledge at Individual and Organisational Levels. *Online Information Review*. 33(6). 1021–1039. <https://doi.org/10.1108/14684520911010981>.
10. Abdullah, F. (2006). Measuring service quality in higher education: three instruments compared. *International Journal of Research & Method in Education*, 29. 71–89. URL: <https://www.tandfonline.com/doi/abs/10.1080/01406720500537445?journalCode=cwse20>.
11. Akhlaghi, E., Amini, S. & Akhlaghi, H. (2012). Evaluating Educational Service Quality in Technical and Vocational Colleges using SERVQUAL Model. *Procedia - Social and Behavioral Sciences*. 46. 5285–5289. URL: <https://core.ac.uk/download/pdf/81193856.pdf>.

12. Al-Haddad, S., Taleb, R. & Badran, S. (2018). The Impact of the Education Services Quality on Students Satisfaction: An Empirical study at the Business Schools in Jordan. *International Journal of Business Excellence*, vol.14 (3). 393–413. URL: https://www.researchgate.net/publication/323160685_The_impact_of_the_education_services_quality_on_students'_satisfaction_An_empirical_study_at_the_business_schools_in_Jordan.
13. Dudka, T., Gurzhii, A., Kartashova, L., Sorochan, T. & Spitsyna, A. (2020). Social and professional designing of tourist destination management in the professional training of future tourismologists. *Revista Turismo Estudos & Práticas*, 2. 1-10. URL: [http://natal.uern.br/periodicos/index.php/RTEP/article/view/1299/1240\[in English\]](http://natal.uern.br/periodicos/index.php/RTEP/article/view/1299/1240[in%20English]).
14. Faganel, A. (2010). Quality perception gap inside the higher education institution. *International Journal of Academic Research and Development*, 2(1). 213–215. URL: https://www.researchgate.net/publication/242494091_QUALITY_PERCEPTION_GAP_INSIDE_THE_HIGHER_EDUCATION_INSTITUTION.
15. Madani, R. (2019). Analysis of Educational Quality, a Goal of Education for All Policy. *Higher Education Studies*. 9(1). 100–109. URL: <https://files.eric.ed.gov/fulltext/EJ1203706.pdf>.
16. Prentice, G., Brady, J. & McLaughlin, C. (2018). Education Service Quality, Value and Satisfaction on Student Customer Intentions and Behaviour. *DBS Business Review*. 2. 89-112. URL: https://www.researchgate.net/publication/329290676_Education_Service_Quality_Value_and_Satisfaction_on_Student_Customer_Intentions_and_Behaviour.
17. Strielkowski, W., Kiseleva, L. & Popova, E. (2018). Factors Determining the Quality of University Education: Students' Views. *Integration of education*. 22. 220–236. URL: https://www.researchgate.net/publication/329290676_Education_Service_Quality_Value_and_Satisfaction_on_Student_Customer_Intentions_and_Behaviour.
18. Moosavi, A., Mohseni, M., Ziaifar, H., Azami-Aghdash, S., Gharasi, M. & Rezapour, A. (2017). The Quality of Educational Services from Students' Viewpoint in Iran: A Systematic Review and Meta-analysis. *Iran Journal Public Health*, 46(4). 447–455. URL: <https://www.ncbi.nlm.nih.gov/pubmed/28540260>.

Olena Veligura

*Specialist in educational methods of the form piano and vocal
of the Communal institution «Semenivska children's music school»
Chernihiv region, Semenivka, Ukraine*

THE CONTINUITY IN THE FORMING SINGING SKILLS OF JUNIOR PUPILS

Abstract. *The article is devoted to the problem of continuity in the work of the institutions of pre-school education and the primary link of the institutions general secondary education. The phenomenon in principles, the methods and the methodical approaches is revealed. The following concepts are introduced into scientific circulation: «the continuity of forming singing skills», «the continuity of the principles of vocal education», «the progression of skills», «the regression of skills», «relapse of improperly formed skills», «the stabilization of skills», «reflection singing», «the mobility of repertoire», «the mobilization of educational process», and «the mobilization of forming singing skills». The continuity is considered in the principles, in the methods and in the methodical approaches.*

Introduction.

The article's purpose is exposing the different interpretations and visions of the principle of the continuity between the preschool and primary school level of the education, the modern approaches for the implementation of its phenomenon. Also introducing the following concepts into the scientific circulation: «the continuity of the forming singing skills», «the continuity of the principles of vocal education», «the synchronicity of the formation of singing skills», «continuity in the methods», «the progression of skills», «regression of skills», «relapse of an improperly formed skill», «stabilization of skills», «reflection singing», «the mobilization of the educational process», «the mobility of the repertoire» and «the mobilization of the forming singing skills».

The methodological base of the investigation was: the state document «National Strategy and Development of Education in Ukraine for 2012-2021», the leading aspects of the methodic of the vocal and the choral work with the children (O. Apraksina, O. Borisova, K. Malinina); the main positions of the peculiarities of the structure of the children's vocal device (N. Hontarenko, L. Dmitriev, A. Menabeni, M. Mikisha, V. Morozov, Y. Yutsevich, V. Yushmanov); the theoretical principles of the continuity's phenomenon (L. Vihotskiy, V. Davidov, O. Leontyev, O. Kononko); the theoretical principles of continuity between preschool and primary education (O. Bohinich, A. Bohush, N. Bushueva, N. Nazarenko, Z. Onishkiv); the main principles of the age-specific peculiarities of the development of the psyche of the preschoolers (O. Kononko, V. Kuzmenko) and the children of the junior school age (L. Wenger, M. Zabrotskiy, V. Kuzmenko, V. Kutishenko); the modern programs of upbringing of the children of preschool age (Z. Plohiy; O. Kononko; O. Bilan, L. Vozna, O. Maksimenko, L. Ovcharenko; K. Krutiy, O. Andrietti, O. Holuboviy; O. Dolinna, T. Dyachenko, G. Ivanova, G. Lisenko, T. Panasyuk).

The scientific novelty is in that:

Firstly, the problem of continuity is considered in the forming singing skills of the pupils is the primary link of the institutions of general secondary education and the preschoolers.

Secondly, was introduced into scientific circulation the following concepts: «the continuity of the forming singing skills», «the continuity of the principles of vocal education», «the synchronicity of the formation of singing skills», «continuity in the methods», «the progression of skills», «regression of skills», «relapse of an improperly formed skill», «stabilization of skills», «reflection singing», «the mobilization of the educational process», «the mobility of the repertoire» and «the mobilization of the forming singing skills».

Thirdly, in the investigation presented a flexible system of interaction of the principles, the methods and the methodical approaches of the forming singing skills.

Fourthly, implemented analysis of the modern programs' primary link of the institutions of general secondary education «Music».

This phenomenon implies the gradual forming singing skills. The continuity in training presents a flexible system of interaction of the principles, the methods and the methodical approaches. Utilizing this system leads to a higher stage of the development, which we called the progression of skills. In the modern programs' primary link of the institutions of general secondary education from the subject «Music» does not suggested the personality-oriented approach is absent the principle of the continuity in the forming singing skills of the junior pupils.

Formulation of the problem in general aspect and its connection with important scientific or practical tasks.

Today, due to changes in the primary education of Ukraine, the problem of continuity of learning has become an important one. The modern scientists (Sh. Amonashvili, T. Andreeva, A. Bogush, V. Kotyrlo, V. Kuznetsova, N. Moiseyuk, G. Nazarenko, O. Savchenko, T. Chala and others) are investigating this phenomenon, but their researches has not yet found its reflection on the problem of the continuity of the forming singing skills. The state defined the task of embracing the education of all children of preschool age and creating the prerequisites for a gradual transition to the education of younger schoolchildren. The continuity provided the creating of a developing environment with the same psychological and pedagogical conditions, the forms of work and a personality-oriented approach to each pupil. In the institutions of pre-school education and the primary link of the institutions general secondary education, this approach causes a change in the usual stereotypes also. This leads to a change in attitudes and habits in the upbringing of children by qualified pedagogical staffs who have been working according to established programs for several decades. Their understanding of the fact that such a construction of the educational process can contribute to a comprehensive, multifaceted, widest and consistent development of the pupils will ensure their personal growth from 3 to 10 years, which is a priority position of the «National Strategy for the Development of Education in Ukraine 2012-2012 of the year».

An analysis of main investigations and the publications of the taking problem.

The problem of the continuity in education is extremely broad and multifaceted and in our time is the object of investigations in various branches of science: philosophy, psychology, pedagogy, aesthetic and the musical education. Therefore, its current state is characterized by the versatility of covering many issues and the ambiguity of their explanation. The philosophical aspect of the continuity is considered in their scientific works by such scientists as E. Buller, G. Isaenko, B. Kedrov, and others. For the first time in their works, they substantiated the concept of «*continuity in learning*», which over time became the subject of many studies in national and foreign pedagogy. In pedagogy, the problem of the continuity was considered by domestic scientists, namely: Sh. Amonashvili, T. Andreeva, A. Bogush, V. Kotyrlo, V. Kuznetsova, N. Moiseyuk, G. Nazarenko, O. Savchenko; and foreign: Y. Komensky, Y.- G. Pestalozzi and others. They identified several conditions for creating a comfortable climate for first-graders, namely: creating an emotional climate, building an educational process taking into account the psycho-physiological and individual characteristics of six-year first-graders, having the necessary equipment, etc. Psychological and pedagogical foundations of the continuity were justified by foreign psychologists: L. Vygotsky, V. Davydov, D. Elkonin and Ukrainian: J. Kolominskiy, G.

Kostiuk, G. Lyublinskaya and others; the continuity in the musical and aesthetic education is highlighted in the works of R. Lyubar, L. Kurysheva; in the functioning of the kindergarten and school opened by the following scientists: A. Bogush, N. Bushueva, I. Lapshina, N. Mangeliy, L. Poryadchenko, O. Chepka, etc.

The article's purpose is exposing the different interpretations and visions of the principle of the continuity between the preschool and primary school level of the education, the modern approaches for the implementation of its phenomenon and also introducing the following concepts into the scientific circulation: «the continuity of the forming singing skills», «the continuity of the principles of vocal education», «the synchronicity of the formation of singing skills», «continuity in the methods», «the progression of skills», «regression of skills», «relapse of an improperly formed skill», «stabilization of skills», «reflection singing», «the mobilization of the educational process», «mobility of the repertoire» and «the mobilization of the forming singing skills».

The continuity as the pedagogical problem

The educational process between preschool and primary school education is of an intermittent character, so all knowledge and skills acquired by younger schoolchildren at the preschool age do not have a progressive stage of development. To solve this problem, to ensure the effectiveness of training, we consider it expedient to introduce of the continuity in the educational process of the institutions of preschool education and the institutions of the general secondary education.

The continuity has a great importance in the pedagogical work, since it is foreseen the gradual forming of the necessary knowledge and skills, their updating and deepening at each of the stages. A. Bogush thinking that «the uninterrupted learning is a multicomponent education, and it's the effectiveness depends from the implementation of such factors as the continuity, the heredity, the prospects and the readiness. In this understanding, the continuous education gives the possibilities for achieving the integrity and the continuity in the training and the education, putting the education into a process that lasts a lifetime» [3, p.10].

G. Nazarenko in the dissertation determined the following components of the continuity: «the development of visual and auditory analyzers, of the sensorimotor coordination, of the cognitive activity, of the creative imagination, of the coherent speech» [9, p.11].

T. Erahtina investigated the theoretical foundations of managing the process of the continuity of preschool and the primary school education. She defined the continuity as «a process directed at the development and the improvement of any sphere of the human activity, which is the unity of the qualitative and quantitative changes in the system» [7, p.99]. She thinks that these changes contributing to the appearance of the newborns associated with pre-existing signs. The scientist attributed to the continuity between the preschool institution and the primary school the following components: the continuity in the content of education, in the upbringing, the preservation of health, the mental and personal development [7, p.99].

In turn, T. Oniskevich, taking into account the current state of the reformation of education, the introduction of the newest learning technologies, the alternative and alternative programs, referred to the continuity of the goals and content, methods and means of learning, the issues of learning, the intellectual development of children and the creation of positive motivation to learn [7, p.99].

The theoretical basis of the continuity process was investigated by A. Smantser. He distinguished out two subsystems of a determined phenomenon, namely: the internal (the

educational-cognitive activity of pupils) and the external (the professional-cognitive continuity associated with the activities of teachers). In the first, he distinguished out the following components: motivational-targeted, substantive-active, educational-operational, evaluative-reflexive, organizational-planning [7, p.99].

Generalizing the different views of the scientists on the structure of the continuity, we have taken this phenomenon as a basis for the scientific research as an important factor in children's singing activity. The introduction of principle of the continuity in the educational process will allow it to improve and will make it more convenient, so the question arises of the concretization of the concept of *«the continuity in the forming singing skills of the preschoolers and the younger pupils»*. We define it as the acquisition of the special musical skills in the process of singing activities of children from 4 to 10 years, taking into account the individual psychological characteristics of the preschoolers and the younger pupils, updating of the singing skills at each stage in the prospects them improving, providing a system of interconnections in the content, the principles, the forms, the methods and the methodical approaches of working with them at all stages of training.

The continuity of the forming skills is the process of the emergence of one skill on the basis of another, which serving in the future as a foundation for the education and the development of other skills and at the same time improves. It must be emphasized that the quality of the formed skills is increased, updated and improved at each of the following stages. The reason is in the physical and the psychological development of children. We are thinking that the continuity presupposes a flexible system of interaction of the principles, the methods and the methodical approaches of teaching. *«The continuity of the principles of vocal education»* is defined as the interaction and the ability to increase the level of formation of the relevant skills at each stage.

«The continuity of the methods» is associated with their variability and the interaction of the named phenomenon, which improves the learning process. In our investigation, for the implementation of the continuity between preschool and the primary education, it is necessary to use the following methods: play, singing exercises from drawings, the performing shows, the talking and others. The methods should be convenient and accessible for a specified age of children. In connection with the dominance of visual-figurative thinking in the preschoolers and younger pupils, we consider it expedient to use the visual teaching methods.

«The continuity in the methodical approaches» presupposes their variation on depending from the use of the musical material, the individual abilities of each child.

We are thinking that the *«continuity in the methods»* lies in ensuring the mobility of the development of links between the skills. We assume that the using of principle of the continuity in the principles, the methods and the methodical approaches will lead to a higher stage of the development, which we called *«the progression of skills»*. The progression of skills is obtaining their abilities in a short period of time to be adopted and will get the maximum the quality development. This phenomenon will be unequal for each skill. The reason lies both in the unformed fragile children's vocal device and in the phenomenon of compensation, which, in our opinion, implies a deep development of one skill at the expense of others.

In addition, throughout the entire period of training, we distinguish the following stages of the formation skill: the familiarization (its perception is visual or auditory), the initial emergence, the process of its formation, its updating and the development, the improvement. The period from familiarization (visual or auditory) to the moment of the final mastering of skills, we called them *stabilization*. The stabilization process takes place over a period of time.

This is confirmed by the fact that an action always requires repetition, with a goal to obtain the desired result. The reason lies in the irradiation of nerve processes in the cerebral cortex, the consequence of which is a significant quantity of errors during fulfillment of the tasks. In the process of the stabilization, we distinguish three stages: the primary (initial), fixing (dominant) and confirming (final). In our opinion, the rejection from using of the continuity in the principles, the methods and the methodical approaches, will lead to a temporary loss of their ability to acquire new qualities in an insignificant time's interval. We define it as a *regression of skills*. The following factors may be the consequence of such process: the transfer of the disease of the vocal device, the lack of updating skills during of a long time's period, the psychological discomfort of the subjects of training. The singing skills are in the constant relationships, that is, one formative encourages the emergence and the development of another. This synchronicity gave us the opinion to define such process as *«the synchronicity of the formation of singing skills»*. The skills are being developed at the same time, but experience has shown that, sometimes there is a halt in improving the quality of any one of them. The reason is the excessive intensity of such process. The others are the further developed. After a certain time, this skill resumes. This process we can call *«the renewal of the progression of skill»*.

Y. Yutsevich informs that there is a direct connection between listening to music and the vocal device, since *«the auditory influences go to the auditory organ and the brain continuously, giving rise to the reflex work of the listener's vocal device without the sound for the scheme: the hearing – the brain – the vocal device (without the sound) - hearing, etc»* [12, p.114]. Y. Yutsevich informs that in this case *«the processes occur in the voice device that are similar to those, encoded in the audio information, which is perceived by the ear»* [12, p.114]. Assuming that any sound heard at the subconscious level affects on the processes in the voice device, which are fixed by the brain (preserved in a memory). The inappropriate singing (forced) leads to the undesirable consequences, since it forms such muscular sensations in the child's voice device. Due to the lack of development of the singing reflection in a child, this process can be renewed by a new wave. We called it a *«relapse of an improperly formed skill»*.

O. Leontyev noted that *«the educational process is saturated by the knowledge which a pupil should master, but must be saturated by understanding»* [10, p.34]. The scientist was referring the reflection. The reflection is defined as *«epic mental activity, which is manifested in clear thoughts in the form of a statement of what happens with other people and with the person himself»* [10, p.35]. Philosophy regards this concept as a form of theoretical activity of a socially developed person, directed at understanding its own actions and their laws; the self-knowledge's activity, revealing the specifics of the spiritual man's world. From the psychology's point of view, the concept of reflection is an introspection, a person's thoughts (with time being excessive, painfully aggravated) over their own mental state.

In a broad significance, the reflection is considered as *«the ability of a person to self-analyze, think and rethink their social relations with the outside world, as a necessary component of the developed intellect»* [5, p.299]. V. Zhelanova expresses the idea that *«the reflection is related to the self-consciousness of the individual»*, understands it as a process of self-knowledge of the subject, directed at uncovering the inner spiritual world, at building of an integral image *«I»* [5, p.299]. The phenomenon of reflection is multifunctional, as a person pays attention on the perception of his behavior, the inner world, actions by another person. According to L. Vygotsky's researches, M. Lysina, the first manifestations of reflection are observed in the preschool children,

but V. Zhelanova emphasizes that at the beginning of this age the children are not reflexive yet. This is confirmed the famous teacher K. Ushinskiy, who believed that the preschoolers have a feature – the imitation. V. Zhelanova, based on the phenomenon of thinking's egocentrism of the famous Swiss psychologist J. Piaget, who argued that the child expresses only his own thoughts and «is not able to correlate them to other people's points of view, that is, not capable of the decentration» [5, p.299]. Interestingly, the child believes that others perceive him as he does himself. Then, the child overcomes egocentrism through the perception of other people's points of view [5, p.299].

In primary school age, the reflection is enriched by new qualities. The main factor of its development is the learning activity, in the process of which the intellectual reflection develops. V. Davydov testifies that «before the end of the elementary school more than half of the schoolchildren have the intellectual reflection» [4, p.300]. G. Tsuckerman connects the pupil's reflection of an elementary school with the ability to learn.

The personal experience has shown that the reflection takes place in music lessons, in musical activities, that is, the reflection is a newborn of primary school age, and possession of the means of developing reflection in the elementary school optimizes its complex process. However, the indicators of its development agreed with the opinion of V. Zhelanova. So, the children are not reflexive at first. The preschoolers do not have such a newborn. They are only able to copy the dynamics of the voice of a music director, able to the sound imitation and only from six years can compare the present sound of their voice with the past sound of their voice. Also, they are able to discern the pitch of the sounds, the duration, the dynamics (loudly or quietly), the methods of sound extraction (legato, staccato), have children gradually develop a singing reflection. A. Avdievskiy and A. Bolgarskiy in the «Project of programs from the music of the secondary school» emphasize that first-grade pupils should «follow the correct singing performance» [1, p.23], and third-grade schoolchildren are required to «consciously work on the diction and the correct articulation of sounds» [1, p.24]. The pupils of the fourth form should «evaluate their singing and the singing of comrades regarding the correctness and expressiveness of the performance» [1, p.24]. In these indicators, the authors had in mind the reflection of singing as a newborn in six-year-old children. Since, in our investigation, the main factor is the continuity, we consider it expedient to introduce the concept of «*the reflection of singing on the basis the principle of the continuity*» into scientific use and we define as a gradual upbringing in children of the ability to determined as the continuous development of the ability to compare own capabilities of singing, the high-quality sound of the voice with the low-quality one (forced or false), and in general, the ability to evaluate one's performance. In our opinion, the forming of children's reflection encourages their curiosity and interest to the music lessons in the preschoolers, and the music lessons for younger schoolchildren; bringing up a desire to be the best. We divided the reflection of singing into the following divisions:

- the reflection of exercises in the drawings;
- the reflection of the implementation of the musical game;
- the reflection of singing songs;
- the reflection of performances at the concerts.

The reflection of performing exercises in the drawings - the child's understanding of the sound imitate of the singing's elements or sound production (looking at the image).

The reflection of the implementation of musical game is children's discrimination of the rules and implementation of actions during this type of the activity. The reflection of singing songs is the children's ability to distinguish reference singing from fake and forced singing.

The reflection of performances at the concerts is the children's ability to quickly psychological adaptation to new conditions, the ability to accumulate gained skills and the singing skills with the goal to exposing the artistic image. On the singing reflection is influenced methodological, physiological and the psychological factors. Our proposed training system will lead to its mobilization. The using of convenient and effective principles, the methods and the methodical approaches and education we called «*the mobilization of the educational process*». We concluded that the mobilization of the educational process implies a systematic, expedient and accessible use of the principles, the methods and the methodical approaches of training with their compulsory single-minded conglomeration. We believe that the essence of mobility lies in achieving an effective learning' result in a short time's period. Unsystematic, monotony and lack of initiative in using of the principles, the methods and the methodical approaches leads to the demobilization of education, that is, the disproportion in the forming singing skills and the inconsistency of their natural development.

In the lessons of junior schoolchildren, lasting 40 minutes, the process of singing is allocated only an insignificant the time's part for singing and for getting acquainted with new material, and for repeating learned songs. In addition, in the music lessons in the institutions of the general secondary education, methods and the methodical approaches are used chaotically, a plan for the forming singing skills do not has the promising development. For the effectiveness of the singing process, we consider it necessary to introduce such principles, the methods and the methodical approaches in the education of children, which would be convenient and promote the learning of the educational material in a short time's period. For this reason, it would be advisable to introduce the concept of «*mobilization of the forming singing skills of the preschoolers and younger pupils*» into the scientific circulation. We defined it as prepared, expedient, prospectively planned, systematic, regular use of convenient and the effective principles, the methods and the methodical approaches in the children's training from four to ten years old. This phenomenon is important in the selection of songs. So, the prospectively planned repertoire for the gradual and long-term development of the singing skills of the preschoolers and younger pupils we determined as «*mobility of the repertoire*».

Consideration the principle of the continuity in the modern programs' primary link of the institutions of general secondary education «Music»

The modern programs of the institutions of the preschool education and the institutions of the general secondary education have some specificity, the directions and the principles on which base the general children's music development. The line of the development of the children's music upbringing is implementation on the base the Ukrainian national culture in the programs and the methodical working for 1-2 and 3-4 forms of the institutions of general secondary education. The pupils' musical perception is subordinated some stages – subject of the programs. The mastering singing skills and the program's demands must be occurring in the obedience of the concrete goal. In the first grade is emphasized on the restriction of the sound's power and the careful development of the range. In the second grade is proposing to implementation the future forming singing skills. In the tasks of the outlined documents is absent the singing reflection's development, the mastering singing skills on the base of the principle of the continuity and personality-oriented approach to pupil's singing potential.

The compiler of issue «In the world of music» T. Naumenko among the demands advancing the following: to study of the children to sing with natural voice, to adapt for adult's sing in the program of children's upbringing of the preschool age Z. Plohiy «Kiddy». She does not rely on the idea of the continuity of the mastering singing skills. In this program don't indicate the forming outlined phenomenon.

The compiler of «Basic program of the child's development of the preschool age «I am in the world» - O. Kononko is recommended begin the forming singing skills in junior preschool age (4-5 years), since in researcher's opinion in the indicated age «conceiving the types voice's singing» [6, c.149].

The outlined age «is promoted for the forming singing voice, the manifestation of its type, but the ability intonating of melody by the voice is not forming yet», «the singing voice is mainly feeble, hoarse, the breathing is short, the fuzzy articulation... The child sings willingly the simple songs, singings their expressively and musically; has the ability to distribute the breathing, is ability to corresponding the bearing of body's posture during singing» [6, c.149]. O. Kononko is confirming that in the senior preschool age «continues develop vocal chords, to form of the larynx's vocal device, a voice is acquire new possibilities, intone the melody is become more clear. The majority of the children are reproducing the general direction of the melody's movement, and some of them are intone exactly its individual segments. The intonation improves, strengthens and prolongs breathing» [6, c.237]. However, does not indicated by the author the concrete mechanisms for the improvement singing activity, does not suggested the methods and the methodical approaches for the mastering singing skills by the pupils on base the principle of the continuity. A compiler does not gave one's view about valuing by the children own singing. In our opinion, this is deficiency in the outlined document's contents.

The compiler of the «Program for the comprehensive school 1-4 forms» O. Lobova laid the foundation the uninterrupted personality-oriented musical education, which called in author's thought «on the development in the schoolchildren the ability for perception, understanding and valuing of musical art, creation of artistic characters, necessities in the aesthetic-creative and spiritual self-realization» [8, c.372]. The program base on «didactic principles of nature compliance, culture compliance, the arts' synthesis and the aestheticization of the education process, personal and the individual approach with the support on the child's experience, the integration of knowledge, the consistence, systematic and the continuity of training, availability in the connection with the high complexity's level etc» [8, c.372]. In the contents and the didactic-methodical concept of the program indicated to realize the ensuring of the sequence and the continuity of educational process.

The repertoire suggested with the support on the theme-based and calendar planning, without consideration the pupils' individual singing possibilities. In a program is absent the concept of the reflection singing, the pupils' cognitive development what presupposed the ability valuing own singing. The continuity is absent in the gradual forming singing skills, the training's consistence is considering only from the point of view perception of music, the comparison of the music compositions; study of the peculiarities and the purpose of the different musical instruments, vocal and the instrumental music; creation of rhythmic and the vocal improvisations in the accordance music's personality. The goal and the tasks of its document aren't foreseen the pupils' forming singing skills on the base the principle of the continuity, ensuring of the incessancy educational process.

One of the principles of the «Program for secondary comprehensive school» by O. Rostovskiy, L. Hlebnikova, R. Marchenko is personality and activity approach. The goal and the tasks of its document aren't foreseen the pupils' forming singing skills on the base the principle of the continuity, ensuring of the incessancy educational process. The author's foreseen the simultaneous interconnected development of the music abilities and singing. This Program

presupposed some topics and foreseen the mastering skills to perceive, to analyze, to perform of music, taking advantage the different activity's aspects with the pupils on a lesson. Among the tasks of second form are the awareness of the expressive and the pictorial possibilities of music. The singing and dancing to study in the third form [11, c.347]. The tasks of fourth form are found on understanding of the Ukrainian national Melos.

The analysis of the outlined program allowed drawing new conclusions: among the main tasks is absent the development of reflection of singing, the mastering singing skills on the base the principle of the continuity and personality-oriented approach to the vocal upbringing the younger pupils. In the program of the child's development of preschool age «The Ukrainian preschool» by O. Bilan, L. Vozna, O. Maksimenko, L. Ovcharenko, the authors offers «to develop the children's singing skills» [2, c.41]. In this document for senior preschoolers in their age possibilities outlined: strengthening and lengthening of the breath. In the part «Singing» among the tasks is «to develop the ability to incomplete right and false singing», which it is the reflexia. Outlined phenomenon is newborn of the pupils of six years of the institutions of general secondary education. Among the indicators of child's competence indicated «developed harmonious hearing» [2, c.234]. In our opinion, the children of outlined age have melodic hearing. Authors separated every stage of study of the songs in this Program. This approach is foreseen gradual forming singing skills, their improvement. We called this process the continuity in the work with the vocal repertoire of the preschoolers.

In this Program the authors does not indicated the interaction of the institutions of preschool and general secondary education. In the «Project the programs of music of the secondary comprehensive school and extracurricular work from music 1-4 forms» by A. Avdievskiy, A. Bolharskiy is absent the principle of the continuity in the mastering singing skills by the younger schoolchildren and the personality-oriented approach. However, authors indicated that the pupils of fourth form must «valuing own singing and the mates' singing relatively the right and expressive of performance» [1, c.24]. In our opinion, they mean the reflection of singing.

The Program of the development of the children senior preschool age «Confident start» has the personality-oriented approach to the training of the preschoolers. Not provided in this document the uninterrupted forming singing skills on the base of the continuity. In integrated program of new type «The child in the pre-school years» by T. Sorokina not provided consideration of the singing development with the demands of the primary school. So there is absent the continuity and also personality-oriented approach in the forming singing skills of the preschoolers. The program of upbringing and training of the children from 2 to 7 years «Child» is integrated and represented the demands to the contents of the preschool education. Also in this document does not offer the forming sensing skills on the base of the continuity. So, in all programs is absent the principle of the continuity in the forming singing skills. Not all programs offered the personality-oriented approach to the development of singing potential of the junior pupils of the institutions of general secondary education.

Conclusion

As our investigation has shown, the continuity is the main principle for successfully overcoming the barrier between preschool education and the primary link of the institutions of general secondary education and contributes to the creative development of the children. This phenomenon implies the gradual forming singing skills. The principle of the continuity allows improving the educational process, in particular, the forming singing skills of the preschoolers and junior pupils.

The continuity in training presents a flexible system of interaction of the principles, the methods and the methodical approaches. We concluded that its use leads to a higher stage of the development, which we called the progression of skills. In our opinion, the rejection of the implementation of this phenomenon will encourage to the regression of skills. Six-year-old children have a reflection of singing, which is the foundation for their singing development. The reflection of singing is influenced by methodological, physiological and the psychological factors.

The prepared, prospectively planned, systematic and regular use of convenient and the effective principles, the methods and the methodical approaches in training of the children from four to ten years old will provide the so-called mobilization of the forming singing skills of the preschoolers and junior schoolchildren what are in the constant interaction and are being formed simultaneously. The analysis of the modern programs' primary link of the institutions of general secondary education from the subject «Music» has show that in them is absent the principle of the continuity in the forming singing skills and does not suggested the personality-oriented approach to the development of this phenomenon of the junior pupils.

References

1. Avdievskiy, A. T., & Bolgarskiy, A. G. (1991). The project of the program of music of the comprehensive school and the outwork of the music of 1-4 forms. Kyiv [in Ukrainian].
2. Bilan, O. I., & Vozna, L. M., & Maksimenko, O. L. (2013). Program of the development of a child of preschool age «Ukrainian preschool». Ternopil: «Mandrivets», 264 [in Ukrainian].
3. Bogush, A. M. (2003). Modernization of preschool education into the context of national doctrine of the development. Glukhiv: GDPU, 171[in Ukrainian].
4. Zhelanova, V. V. (2007). The genesis of the development of the reflection and the formation of forms among junior schoolchildren. Sloviyansk: SDP of the SDPU [in Ukrainian].
5. Zagrebelna, L. A. (2011). The introduction of the modern technologies of the training. Methodical recommendations. Kyiv, p. 15-18 [in Ukrainian].
6. Kononko, O. L. (2008). The basic program of the development of a child of preschool age. Kyiv: «Svitich», 430 [in Ukrainian].
7. Litvina, N., & Kondratenko, T. (2010). The problems of the continuity in the educational work of the preschool institutions and the primary school. Kyiv [in Ukrainian].
8. Lobova, O. (2007). The program for the secondary school. Music. 1-4 forms. Kyiv: «Primary school». 393. [in Ukrainian].
9. Nazarenko, G. I. (2002). The organizational-pedagogical conditions of ensuring of the continuity in the training of the children of preschool age and the younger school age. Extended abstract of candidate's thesis. Kriviy Rig, Ukraine.
10. Pehota, O. M. (2002). The educational technologies. Kyiv: A.S.K. [in Ukrainian].
11. Rostovskiy, O., & Hlebnikova, L., Marchenko, R. (2007). The program for the secondary school. 1-4 forms. Kyiv: «Primary school». 371. [in Ukrainian].
12. Yutsevich, Y. C. (1998). The theory and the methods of the formation singing voice. Kyiv: IBMN, 160 [in Ukrainian].

Lyudmila Sidorchuk

Doctor of Pedagogical Sciences,

Head of the Department of Department of Management of Professional Education

National Aviation University, Kiyv, Ukraine

Tetiana Sivashenko

Candidate of Economic Sciences,

Associate Professor, Associate Professor of Department of Management of Professional Education

National Aviation University, Kiyv, Ukraine

**IMPLEMENTATION OF NEW INNOVATIVE TECHNOLOGIES IN THE
EDUCATIONAL PROCESS OF UKRAINE AND THEIR INVESTMENT**

Abstract. *The formation of the domestic market for educational services is carried out in the context of reforming the economic system and is the result of resolving the contradictions that have arisen in the educational system of Ukraine since its independence. The market transformation of the Ukrainian economy has contributed to the diversification of higher education funding sources in terms of the combination of budgetary financing and commercial financial resources. In the context of the growing role of extra-budgetary financial resources, an important issue is the creation of research and production complexes that will facilitate the commercialization and dissemination of research and innovation. The problem of financing of educational institutions determined their involvement in other areas of commercial activity. The planning process is one of the key to creating effective educational institutions, but factors such as inflation, downturns in educational products and services, an imperfect tax system create unfavorable conditions for business planning. The spread of new technologies deepens the differentiation between different segments of the population - those who have access to technology, able to increase their own production, professional skills, knowledge, experience, etc .; instead, those who are deprived of this access are in fact outside the limits of civilizational progress, deprived of effective tools for development, professional growth and self-realization. The introduction of innovative education can take place when teachers and students are actively engaged in innovative activities.*

Introduction

Specific features of the educational market are related to the fact that the educational services provided are inseparable from pedagogical activities. The quality of pedagogical activity largely depends on the individual, his position, knowledge, professionalism, attitude to the case. Therefore, stimulating the work of the teacher, stimulating his professional growth is a condition for improving the quality of educational services. This defines the task of marketing services in identifying the source of additional funding for pedagogical activity, as well as finding financial resources to improve the quality of professional retraining of teachers.

The educational complex of the country, spontaneously involved in the market, made many mistakes and miscalculations. Legislative regulation of market activities in the field of education is also in the making. Due to the penetration of market relations in the field of education, the problem of pricing becomes an urgent problem. Prices for educational services are quite high. This is more felt by those who use the services of non-state educational institutions. While maintaining free education in public and municipal institutions, consumers of their services also experience an increase in personal spending on training needs. However, a small part of this expenditure goes to the profit of the development of the school. The penetration of market relations in education, the effect of such market instruments as money, price, credit, competition, to some extent increase the possible profit of educational institutions, creating funds for the development of the material base of the institution and material incentives for employees.

Thus, the expansion of market activity is to some extent an important source of educational development. Therefore, the business plan, introducing civilization into the system of market relations in education, helps to create conditions for improving the quality of educational services. The formation of a new economic mechanism in education, where, alongside centralized rigid regulations, there is room for a market model, implies changes in economic planning.

Socio-economic essence of educational activity lies in the presence in it of the properties of public and private goods, which requires the addition of state regulation by the elements of the market mechanism.

Specific features of the market in education are related to the fact that the educational services provided are inseparable from pedagogical activity. The quality of pedagogical activity largely depends on the individual, his position, knowledge, professionalism, attitude to the case. Therefore, stimulating the work of the teacher, stimulating his professional growth is a condition for improving the quality of educational services. This defines the task of marketing services in identifying the source of additional funding for pedagogical activity, as well as finding financial resources to improve the quality of professional retraining of teachers [13].

The problem of civilization of market activity has become an actual problem for every educational institution. Its solution is seen in the analysis and theoretical generalization of the experience of market activity of various institutions of the education system, in the formation of a special planning culture among the heads of educational institutions and representatives of educational management bodies.

1. The problem of financing and planning

The problem of financing of educational institutions determined their involvement in other areas of commercial activity.

The involvement of educational institutions in the sphere of market relations certainly intensifies the transformative processes within them. The competitive factor has exerted an activating influence on all areas of innovative search for educational institutions. However, the civility of market relations implies the emergence of marketing of educational services. The purpose of marketing in education is the optimal combination of socio-economic interests of the consumer-buyer and manufacturer.

The complexity of the nature of relations in the market of educational services and goods is determined by the special role of the state, which acts as the principal customer, directly pays for the education services that control its results, and the presence of certain contradictions between the state as the main consumer and the private consumer, separately taken by a citizen.

The planning process is one of the key to creating effective operations for educational institutions, according to their resources and capabilities. However, given factors such as inflation, declining sales of products and services, taxes, they can be said to create unfavorable business planning conditions. Currently, most nonprofits and educational institutions do not have a clear business plan or do not use business planning as a management tool at all. Instead of a planning process, certain management decisions are made to ensure that organizations operate for a short period of time. This method of management is explained by the rapid changes in the market situation in Ukraine and economic conditions, the small number of management apparatus of small educational establishments, the authority of managers of large universities with extensive experience [14]

In the absence of clear planning, success cannot be achieved. A well-formed business plan will help to shape the course of the organization, take into account the opportunities for maximum effective activity. Investors are constantly receiving requests for funding for innovative projects, but in order to attract them, they need to be provided with detailed information not only about the mission and objectives, but also a detailed description of the project that will show the prospects for its development.

It is worth noting that most executives consider short-term prospects, but this approach limits the perspective on long-term projections, even in an unstable economy. In addition, instability itself, as a factor, should lead to the formation of many options for the development of events and the assessment of the capabilities and prospects of the institution in certain situations. Difficulties in implementing full-fledged business planning in Ukraine are also created by the lack of real information on the competitiveness of products and the entire organization's strategy, competitive environment, competitive potentials, and the interests of partners are often ignored. In Western business planning, if the product or service is not competitive in quality, the issue of its production is immediately addressed. In the new economic environment, educational institutions have greater autonomy in planning and deciding on innovative and socio-economic development of educational institutions. In Ukraine, there is currently no clear standardization of the business planning process, adherence to recommendations, and recourse to business planning consultants, who should help to prepare a competent and clear business plan and help to take into account all the necessary information for drafting the document.

One of the most common mistakes in the domestic practice of developing business plans is to try to apply the western methodology of developing documents without adapting to the specifics of the business environment. Business planning in Ukraine is based on foreign experience, but it is not possible to completely copy the structure, because it is possible to erroneously ignore the features of conducting and accounting and procedures of a particular organization. Also, domestic scientists have not formed sound methods for creating business plans in accordance with the needs of new market relations [13]. When doing business planning in Ukraine, managers and managers must learn to justify their needs, proving to investors that they can calculate all aspects and use investments not worse than businessmen from other countries.

For successful business planning in educational institutions it is necessary to develop long-term plans with different variants of development in accordance with the changing market conditions and characteristics of the institution. It is worth noting that before drawing up a business plan, it is necessary to conduct a competitor analysis and an in-house analysis.

However, executives often lack the requisite training to develop business plans. They lack sufficient experience in analytical, planning (forecasting) work, assessing the economic effectiveness of projects. Therefore, many educational leaders avoid developing business plans, preferring to manage with the help of intuitive response to difficult situations (reactive management). It is often said that the preparation of a business plan does not make much sense in a fleeting environment, since the provisions contained therein become obsolete before the beginning of their implementation. Planning advice should be addressed to remedy this situation. However, the services of planning consultants, especially long-term ones, are in demand, mainly by major universities or private educational firms (schools, etc.), which tend to resort to consulting services only when the organization is already in a difficult situation. Educational organizations should themselves increase their level of knowledge about business planning, train staff, and involve specialized investment analysts.

For a more detailed understanding of the situation in educational institutions, an in-depth interview with managers and management staff was conducted, and based on the data obtained, we formulate conclusions about the problems of business planning at a practical level in Ukrainian educational institutions:

Firstly, the competence of the staff and managers involved in the business planning process should be addressed. As most of them are guided by an outdated format for understanding the education system, which prevents them from seeing development prospects. At the present stage of economic development it is necessary to adapt to changes and to form curricula in accordance with the tendencies of scientific and technological progress and new market relations. Managers want to ensure stability and do not initiate development that adversely affects the quality of educational services.

Secondly, funding remains an urgent problem for public educational institutions. This problem creates problems of two directions: obsolescence of material and technical base and personnel crisis. Disadvantages of the material and technical base adversely affect the quality of educational services, due to the inability to acquire and absorb knowledge in practice. This problem remains relevant for decades, which distorts the image of Ukraine's education system as a whole.

Third, another issue directly related to funding is staffing. Highly skilled workers wish to receive high salaries, and in the conditions of organization budget constraint, it is necessary to recruit the staff who agrees to work for less money. Therefore, the qualification of employees may not be sufficient to provide quality educational ambassadors or to make management decisions.

Fourth, besides these obvious problems, the question arises in choosing the direction of innovation activity. Educational institutions that have taught schoolchildren and students for years often do not see the prospect of implementing innovative projects [15].

Therefore, business planning for innovation processes in educational institutions has a number of problems. Most executives see short-term prospects and do not form perspectives and directions for long-term development. In an unstable market environment, instability must be taken into account, as a factor that should prompt many options for the development of events.

For example, the search goals of a marketing service in a system of educational institutions are focused on gathering information, which allows to study the demographic environment of the surrounding school; socio-ecological environment (market infrastructure, system of social service, structure of income and family expenses, labor market, social structure of society).

Due to the penetration of market relations in the field of education, the problem of pricing becomes an urgent problem. Prices for educational services are quite high. This is more felt by those who use the services of non-governmental (private, etc.) educational institutions. While maintaining free education in public and municipal institutions, consumers of their services also experience an increase in personal spending on training needs. However, a small part of this expenditure goes to the profit of the development of the school. The penetration of market relations in education, the effect of such market instruments as money, price, credit, competition, to some extent increase the possible profit of educational institutions, creating funds for the development of the material base of the institution and material incentives for employees.

Thus, the expansion of market activity is to some extent an important source of educational development. Therefore, the business plan, introducing civilization into the system of market relations in education, helps to create conditions for improving the quality of educational services.

The formation of a new economic mechanism in education, where, alongside centralized rigid regulations, there is room for a market model, implies changes in economic planning.

Marketing in education, encompassing a very specific field of production of services, is an integral part of the reality of all institutions in this field. Although the nature, structure and content of the services of all units in the education system are different, they are no doubt very soon aware of the complexity and need of pedagogical marketing. The market concept for the management of the production of educational services is aimed at studying the market and economic conditions, specific consumer requests (including the state as a consumer). Thus, targeted pricing policy allows you to change prices depending on the situation in the educational services market.

Therefore, to improve business planning in educational institutions, it is necessary to adapt to the needs of the market, in accordance with the capabilities of the educational institution. It is important when adapting a business plan, based on Western experience, to adapt it to national specifics and own resources. In order to carry out the planning process, it is necessary to first analyze the institution and, based on its strengths, choose the areas of innovation.

One of the biggest problems remains the funding of both the educational institutions themselves and their governing bodies at all levels, since fully state educational institutions have a very limited budget. It is worth noting that the lack of sufficient funds is reflected not only in logistical support, but also in the quality of the staff of the educational institution [1].

Business planning in Ukrainian educational institutions is not as widespread as in foreign countries. However, as more and more educational institutions turn to the search for educational development tools each year, it is the long-term funding plan that can develop and form a new course.

However, there are a number of practical issues in the formation and implementation of financial management. In general, the management of institutions of higher education (IHE), colleges, colleges, and schools, sees the need to plan for shorter periods of time, taking into account the volatility of the market environment. The instability of the economic situation is also a negative factor for organizations.

At present, the central government bodies, together with local self-government and the public of the city (district, oblast), cooperate on the development of draft laws and the development of documents that will improve the financial status of secondary and higher education institutions.

Carrying out education reform is the next solution to the problem of the Ukrainian educational sector. First of all, it is considered through refinancing of financial and logistical support of education based on exemption of educational institutions from taxes on income and value added, introduction of additional financing of educational institutions for gifted children, attraction of foreign investment for development of infrastructure for educational development of secondary schools and IHE.

As practice shows, local budgets are at best financed by so-called «protected articles», including the remuneration of teachers. And the rest is distributed manually. The experience of the termination of financing of vocational education (former professional technical schools – PTS) from the state budget, which happened at the beginning of 2014 at the initiative of the former Minister of Education of Ukraine Dmytro Tabachnyk, says how effectively the mentioned funds are used for the benefit of educational development.

We see that social standards are being set that cannot be lived today. In the text of the law of the state budget for 2020 did not include the norm, which should equal the minimum wage and the first tariff category.

In the new economic environment, educational institutions have greater autonomy in the planning and decision-making of the socio-economic development of an educational institution.

One of the biggest problems remains the funding of both the educational institutions themselves and their governing bodies at all levels, since fully state educational institutions have a very limited budget. It is worth noting that the lack of sufficient funds is reflected not only in logistical support, but also in the quality of the staff of the educational institution.

Business planning in Ukrainian educational institutions is not as widespread as in foreign countries. However, as more and more educational institutions turn to the search for educational development tools each year, it is the long-term funding plan that can develop and form a new course. However, there are a number of practical problems in the formation and implementation of financial management. Basically, management sees the need to plan for shorter periods of time, taking into account the volatility of the market environment. There is also a negative factor for organizations. instability of the economic situation.

In the new economic environment, educational institutions have greater autonomy in planning and deciding on innovative and socio-economic development of educational institutions.

For successful financial planning in educational institutions it is necessary to develop long-term plans with different variants of development according to the variability of market conditions and features of the institution. It should be noted that before drawing up a business plan, it is necessary to conduct a competitor analysis and an in-house analysis.

In order to improve the situation and improve the system of financial planning in educational institutions, it is necessary to prepare managers for defining the main goals of the activity (mission of the institution), or to involve professionals in this business engaged in business consulting. It is the leadership's willingness to innovate and choose new areas of development that will form the basis for long-term planning. It is also important to use your strengths and resources.

One of the ways of withdrawing education from the situation in which the educational institutions are located is the possible financing at the expense of their own parents, entrepreneurs, teachers, sponsors, interested business structures.

Carrying out education reform is the next solution to the problem of the Ukrainian educational sector. First of all, it should be implemented through financing of educational support, exemption of educational institutions and universities from taxes on income and value added, introduction of additional financing of educational institutions for gifted children, children with special needs, attraction of foreign investments for infrastructure development. higher education institutions (HEI) and school educational institutions [14].

2. Information and communication technologies in education

The formation and development of the information society of the twentieth century requires the widespread use of information and communication technologies (ICT), which are rapidly expanding and improving. Particular attention needs to be given to the use of ICT in education, which helps to prepare the future of the state at the proper level. The successful development of a country depends directly on the education and skills of future citizens of all the necessary skills and competencies required by today's society.

E-education is a social movement aimed at bridging the digital divide, namely, increasing the availability of digital media (including computer and networking technologies, television, telecommunications, telephony etc.) for all, except the regions of the planet and all categories of persons, regardless of their characteristics (nationality, race, gender, social status, functional limitations etc.).

Improving the quality of knowledge, through the ability to use and quickly master innovative forms of ICT, enables students to quickly adapt to social change, to solve problems that arise, receive, change or find work at a mobile level.

Using the Internet and its resources remains one of the most accessible and widespread ways to master ICT literacy for people of all ages.

The need to create new information technologies that meet the basic contemporary goals and learning needs of different subjects in schools and HLS is a time-consuming task. Focused on person-centered learning, they should be accessible to the student and teacher at any time and in any city in order to control the quality of knowledge; The ICT involved in the learning process should be directed towards the acquisition of higher levels of skills and competences of both the student and the teacher, to teach collaboration, understanding and tolerance, to develop creative and critical thinking.

Informatization of society is a promising way to economic, social and educational development. The informatization of education is aimed at the formation and development of the nation's intellectual potential, the improvement of forms and content of the educational process, the introduction of methods of teaching and testing using ICT, which enables to solve the problems of higher education in accordance with world requirements.

The modern period of civilizational development of society is characterized by widespread introduction of ICT in almost all spheres of life. The introduction of computer and networking technologies helps to intensify and improve the processes of production, search and exchange of data, education, interpersonal communication across time and space. At the same time, the spread of new technologies deepens the differentiation between different segments of the population - those who have access to technology, are able to increase their own production, professional skills, knowledge, experience etc.; instead, those who are deprived of this access are in fact outside the limits of civilizational progress, deprived of effective tools for development, professional growth and self-realization.

Computer technology in the educational process offers the educator a number of advantages, namely: the ability to go beyond traditional teaching methods; additional motivation for learning activities, especially when other means are powerless; fundamentally new innovative ways for the formation, development and improvement of didactic functions; designing new content areas; expanding the use of various analytical systems in the process; creation of various communication situations during classes; getting students (students / students) to become independent in learning and self-control; development of analytical skills; mastering computer programs and telecommunications technologies.

If there is an innovative model of E-education in the educational institution, the systematic use of e-learning means significant changes in the social-emotional, mental, physical development, in the development of cognitive activity and creativity of students (pupils). Visual reproduction of theoretical and laboratory-practical material by the methods of computer presentation of information, demonstration of video lectures (lessons), use of multimedia tools, work with

simulators, passing of interactive electronic testing, practical tasks for introspection and self-control - all these contribute to the constant development of personal student (student). However, there is a certain «digital divide» between cities and rural areas; between educated and uneducated citizens; between different socio-economic groups; between people with typical development and with functional limitations. Globally, the digital divide is noted between more and less industrialized nations.

In fact, the digital divide conditionally divides people into those who have access to and use of modern information technology and those who do not have that opportunity. If in the twentieth century. the digital divide meant the unevenness of access to telephony, then at the turn of the XX and XXI centuries, it was primarily attributed to the uneven access to the Internet, including broadband.

The main reasons for this gap are lack of appropriate skills, lack of knowledge about the benefits and potential of using ICT, financial inability to buy digital tools and services, lack of access to the Internet due to the geographical isolation of the region, etc. Solving these problems is the prerogative of E-learning.

World experience demonstrates many examples of bridging the digital divide by implementing targeted social programs, implementing projects by leading IT companies, non-government organizations, foundations, and more. In addition to ensuring the appropriate accessibility of technologies, the context of their use, finding appropriate forms of access to information, effective ways of integrating technologies into different activities and interpersonal interaction, the formation and sustainable development of the ICT competences of different segments of the population, it is equally important to develop ICT skills. in the production of new information and knowledge, raising the level of their own well-being, meaningful social activity.

Innovative education involves not only the formation of fundamental knowledge, but also the ability to analyze and solve problems using a problem-oriented and interdisciplinary approach. The problem-oriented approach to learning allows students to focus not only on the analysis and solution of any particular problem situation in the present, but also on the prediction of such situations in the future. An interdisciplinary approach to teaching allows students to independently learn from different fields, grouping them in such a way as to solve a specific practical task.

At present, the promising area of computerization of the educational process is the application and development of work in the cloud environment.

Cloud-oriented educational and scientific environment – educational and scientific environment in which the use of cloud computing technologies (CCT) is ensured to provide ICT support for its functioning and development [12].

The subjects of the environment are students, researchers and pedagogical staff, educators, heads of educational establishments and their structural units, representatives of educational management bodies and others.

Cloud computing as an innovative direction of informatization of education and nowadays the most advanced technologies of the information society itself, play the role of the leading tool of informatization of pedagogical systems of higher education. Their use leads to free access to educational services; consistent with the principles of open education; enables the combination of science and practice; integration of the process of training specialists, implementation of scientific research, implementation of their results [3].

According to the European Union, there has been a steady increase in Internet connection in Europe in recent years. More than half of Europe's population (250 million people) use the network on a regular basis. Approximately 40 million new users emerged in 2018. In fact, 96% of all EU schools in the EU as of March 2019 have an Internet connection. Such communication is becoming a common form of communication for both students and teachers, but it requires appropriate skills [1].

A poll released on the Europe's Information Society website found that 70% of potential workers (survey covered EU Member States) believe that computer skills are very important for getting a job, but only 27% of those surveyed have passed computer training. The problem of computer literacy remains an issue in most European countries [4].

The use of ICT by students (students) motivates them for further learning, lifelong learning, replaces the passive listening of the teacher (teacher) to the interactive process of obtaining knowledge, expanding the classroom.

This learning process provides great opportunities for the student himself:

- use a variety of sources of information
- flexibility in the planning of his study time, taking into account both the time and place of his conduct
- the learner is given greater autonomy to choose the strategy of his / her learning that would best suit him / her
- use different forms and methods of knowledge acquisition
- develop interdisciplinary projects
- to support the development of meta-cognitive skills in self-assessment of their learning process, to develop critical and creative thinking.

According to E.C. Polat: «Didactic features of the Internet can be classified by distinguishing two main classes of computer telecommunications properties:

1. Properties are related to the telecommunication basis (technological capability), the main feature of which is the ability to quickly transmit information at different distances and in different corners of our planet.

2. Computer related properties (including multimedia) related to didactic tasks». [2].

Educational networks combine the above properties. On the sites of information educational networks in the virtual space are placed methodological and informational materials, lectures (lessons), innovative developments, etc., aimed at students (different ages), teachers, educators, parents and people of different age groups. The resources of such networks provide the opportunity to receive on-line training, enhance their professional qualifications or find the necessary information to study and use ICT. The importance of information education networks for the educational process of schools in foreign countries is growing very rapidly.

Thus, the resources of the Internet, the educational networks based on it, in general, ICT, are tools that not only help students to acquire knowledge in various subjects, but also to create in them a creative approach to the learning process, using innovative technologies and methods. . They are assisted by educational portals and networks such as: *BECTA* (British Educational Communications and Technology Agency), *TEN* (Technology Exemplar Network), *Globalschoolnet*, *Educared*, *Happychild*, *Teachers Network* and others. Created on the basis of the Internet, they have their own areas of development, developing techniques for teaching various subjects, conducting project activities, etc.

BECTA's activities are continued by the TEN, a portal founded in 2008, aimed at developing and implementing innovation in education, supporting the study of the use of ICT in education systems. A network of practitioner educators has been created in the network to effectively exchange experiences, review and discuss examples from their practice of technology applications [8].

One of the main areas of the Strategy is the use of ICT in the teaching of all the subjects (academic disciplines) identified in the curricula and curricula of the HEI and the UK general secondary school, which should provide the basis for vocational guidance for school-based students.

The use of ICT in the teaching and learning of any subject does not exclude the role of lecturer (teacher). In recent years, blended learning or hybrid learning have been widely used in the learning process. This new form of learning encompasses two methods: traditional (teacher-listener) and e-learning (use of information and communication technologies). Blended learning is rapidly evolving and its scope is constantly expanding and changing depending on what approaches the teacher uses in his / her practice. Therefore, a stable concept or clear definition cannot be cited at this time.

The American Society for Technology in Education (ISTE) should be noted, which has an impact on the formulation of strategies for the development of ICT in education, the development of educational standards for ICT in Europe [9]. The network's activities are aimed at improving the professional level of teachers, developing innovative approaches and ICT in education, covering all levels of general secondary school, teaching not only teachers but also students to use ICT effectively in the teaching and teaching of various subjects (disciplines), including humanities.

Currently, the network includes more than 85,000 education professionals from around the world. In view of the inevitable changes in the educational processes of the countries of the world, the network provides an opportunity to summarize the experience gained in the use of ICT by other educators, to draw conclusions and to determine directions for the further development of education systems in different countries of the world, by providing recommendations to policy makers and administrators on education, and also helps to obtain the necessary information for anyone about using ICT in their professional activities.

The Northern Alberta Institute of Technology (NAIT) gives the Canadian Interpretation of the term «learning that offers a variety of materials and activities to make the learning process enjoyable, engaging, and relevant. of your interest [10].

The main purpose of blended learning is to strengthen the motivation for student learning and to create a flexible learning process that would not affect how, where and when a student acquires knowledge».

One of the benefits of blended learning is the ability to maximize performance by highlighting the best tool for each segment of the course being taught. Using the traditional classroom (face-to-face) teaching method, you can also receive material from your classmates or teachers. Blended learning gives you the opportunity to share experiences and thoughts with other students, learning how to communicate with different people, which is very important for future life and work.

Another definition can be cited, which, in our view, deserves attention: «blended learning is a combination of many different approaches to learning. Blended learning can be completed through the use of blended virtual and physical resources. A typical example of this would be a combination of technology-based materials, along with the use of classical lessons by a classroom teacher or teacher in a student audience. In a more strict sense, this is when the teacher uses a combination of

two teaching methods. However, this term mostly refers to the use of technology. The best example is a lesson or a lecture in which the traditional method of teaching is accompanied by the use of online materials» [15].

In practice, most teachers apply blended learning using the help materials available on educational web pages. One such popular networking teacher is the Scottish Network of Learning and Teaching with Technology. Networking aims to prepare children aged 3 to 18 for life in the 21st century, enabling them to acquire and improve modern skills and competences through learning and using ICT, receiving online learning through the network, providing online resources for teachers of Scottish schools. Most resources are in the humanities (languages, history, literature etc.) [11].

One tendency is to use educational information networks as a tool for teaching various subjects (English, geography, history, civic education, astronomy etc.).

GlobaSchoolNet's (global education network) has identified the priority of its further development, namely "Learning for the 21st Century" [13]. Her educational projects involve people from all over the world who want to master literacy and communication skills, and teamwork. The purpose of the network is to prepare current students for adulthood, to teach them tolerance towards others, and to be prepared to use their potential in the global society of the future in a dignified, full and effective way. Networking is based on the use of the latest ICT and covers subjects such as geography, languages, history, journalism and more.

It is worth mentioning some more educational networks that play a significant role in the system of general secondary education in foreign countries, helping both teachers and students to increase the level of teaching and learning through the use of ICT, namely:

1. Teachers network in UK covers primary, secondary and higher education. The network contains educational materials, lesson plans, recommendations on various subjects. One of the objectives of the network is to integrate ICT into the teaching of various disciplines in a greater number of which are humanities (Arts and Design; Civic Education, Technology and Design, English, Geography, History, ICT, Mathematics, Modern Foreign Languages, Music, Physical Education education, Social Sciences, Philosophy) and the creation of virtual communities of "subject" teachers [14].

2. Teachers network in America covers all levels of education from primary (secondary and higher). Helps in teaching both teachers and students. Sites have lesson plans, tutorials, and enhancement of their learning through online resources [10].

3. A network of creative teachers in Russia was created for educators interested in improving the quality of learning through the use of ICT [16].

The opportunity to participate in the work of teaching communities and creative groups, discuss important issues in the forum.

Ukraine has successfully operated the International Education and Resource Network (*IEARN*) [18]. The main focus of the network is the development and use of telecommunications in education. The method of networking is the method of projects. Ukrainian teachers from all regions of the country create telecommunication projects in biology, geography, physics, computer science, English, mathematics, literature, Ukrainian, fine arts, history, ecology and other subjects. Recently, there has been a widespread use of research methods in project activities resulting from the collaboration of teachers with Intel@Learning for the Future.

In addition, Microsoft Ukraine has launched the first Ukrainian professional online education resource, the Learning Partnership Network [10], which is an online community for educators, giving educators more opportunities to learn about innovative ICTs to improve learning quality, and also:

- Collaborate with educational institutions around the world
- to learn from fellow innovators how to use technology in education
- have free access to tools and resources in the classroom and more

Conclusions

Human potential becomes a major factor in the production (provision) of educational services in the context of the transition to the information society and the development of the intellectual economy. The need for investment in education and training of personnel is recognized by both governments and entrepreneurs and by employees seeking social and material status.

In order to improve financial planning in educational institutions, it is necessary to adapt to the needs of the market, in accordance with the capabilities of the educational institution. It is important when adapting a business plan, based on Western experience, to adapt it to national specifics and own resources. In order to finance (invest) educational projects and ongoing activities, it is necessary, first of all, to carry out a comprehensive analysis of the educational institution and relying on the identified strengths and potential opportunities to choose the directions of use of innovative pedagogical technologies.

The importance of development and introduction into the education system of the latest, personally-oriented information and communication technologies is indisputable in the context of rapid processes of technology development, production, changes in the economy and social sphere of life of Ukraine. Therefore, an open approach to informing the educational process should become strategic directions of our country's educational policy. Priority should be given to Ukraine's cooperation with other countries in the application of the full current ICT potential in education and the creation of equal opportunities for educational institutions.

The decisive role in the organization of innovative educational process, in the training of personnel to work in the conditions of innovative development is called to play the high scientific and technical potential of IHE. The introduction of innovative education can then be when teachers and students are actively engaged in innovative activities. In addition to professional competence, the teaching staff of IHE must have:

- corporate thinking, ability to anticipate, take an active life position, be proactive, possess high spiritual and moral qualities, be able to make non-standard decisions;
- be able to implement an innovative process of student education and upbringing, have the ability to identify talented students and purposefully develop innovative thinking in them;
- be leaders and individuals who systematically improve their professional level and skills.

So, in order to study the level of implementation of innovative educational technologies, we conducted a study that found the following:

- the departments use combined forms of education, including traditional and innovative forms;
- ICT, multimedia presentations, telecommunication projects are the most widely used innovative teaching methods;
- the productive use of the global Internet in the preparation of teachers and students for lectures and practical classes is noted;

- Internet resources have become widespread.

The market transformation of the Ukrainian economy has contributed to the diversification of higher education funding sources in terms of the combination of budget financing and commercial financial resources. In the context of the growing role of extra-budgetary financial resources, an important issue is the creation of research and production complexes that will facilitate the commercialization and dissemination of research and innovation.

In the context of the study, we define the following issues as problematic and in need of further elaboration:

- computerization of training;
- use of the Internet and telecommunications in the didactic process;
- interactive learning, use of multimedia resources;
- cloud technologies in the didactic process;
- IT in the formation of professional competencies of the student (future specialist);
- the use of ICT in inclusive education;
- the issue of financing the implementation of the latest educational technologies;
- contractual basis of training in IHE;
- continuity of education – as a concept of lifelong learning;
- distance learning issues;
- the link between information technology and distance education;
- internationalization of education as a link to academic mobility.

For effective use in the educational process of modern ICT, the teacher must have certain specific skills:

- apply modern information and communication technologies in preparation, analysis, adjustment of the educational process, management of the educational process and educational and cognitive activity of students;

- to choose the most rational methods and means of teaching, to take into account the individual characteristics of students, their inclinations and abilities;

- effectively combine traditional methodological training systems with new information and communication technologies.

The introduction of new information technologies into the educational process in secondary and higher schools is an objective process of educational development. However, they should not be used by educators thoughtlessly, since neither technology can be considered universal: each of them produces different results in different situations and must be considered when choosing them.

References

1. Boshota N. V., Velychko M. M. (2016) Ways of improving the financial mechanism of the higher education system of Ukraine. *Young scientist*. no 9 (36). Pp. 11-14.
2. Bykov V., Leshchenko M., Tymchuk L. (2017) Tsyfrova humanistychna pedahohika : posibnyk [Digital humanistic pedagogy: a manual]. Kyiv: Vydavnytstvo «LAT&K», 182 s.
3. Dehtyarenko T. M. (2015) Dissemination of ideas of introduction of information and communication technologies in the system of special education. *Information technology and training tools*, no 2 (46). Pp. 11-21. URL: <https://journal.iitta.gov.ua/index.php/itlt/article/download/1207/917>
4. Ely, D. (1990). Conditions that facilitate the implementation of educational technology innovations. *Journal of Research on Computing in Education*, 23, pp. 298-305.

5. Gorbunova L. I., Subbotina Ye. A. (2013) Ispol'zovaniye informatsionnykh tekhnologiy v protsesse obucheniya [Use of information technology in the learning process] // *Young scientist*, no 4. Pp. 544-547. URL <https://moluch.ru/archive/51/6685/>
6. Hurevych R. S. (2015) Informatsiyno-komunikatsiyni tekhnolohiyi v profesiyniy osviti maybutnikh fakhivtsiv [Information and Communication Technologies in the Professional Education of Future Specialists]. L'viv: LDUBZHD, 380 s.
7. Markova O. M., Semerikov S. O., Stryuk A. M. (2015) Cloud learning technologies: origins. *Information technology and training tools*, T. 46. no 2. Pp. 29-44. URL: <https://journal.iitta.gov.ua/index.php/itlt/issue/archive>
8. Zholdak M. I. (2012) Multimedia systems as a means of interactive learning. M ta in. Kyiv: Pedahohichna dumka, 112 s.
9. Polat Ye. S. (2008) Novyye pedagogicheskiye i informatsionnyye tekhnologii v sisteme obrazovaniya / Ucheb. posobiye dlya stud. vyssh. ucheb. zavedeniy [New pedagogical and information technologies in the education system / Textbook. allowance for students of higher institutions]. Moscow: Akademiya, 272 s.
10. Shyshkina M. P. (2014) Perspectives on development of educational environment and improvement of quality of innovative ICT tools. *Humanitarian Bulletin of Pereyaslav-Khmelnitsky State Pedagogical University named after Grigory Skovoroda* - Annex 1 to No 5, vol. III (54). Thematic issue «Higher education of Ukraine in the context of integration into the European educational space». Kiev: Gnosis, 2014. Pp.302-309.
11. Strel'nikov V. Yu. (2013) Modern technologies of teaching in high school: a modular manual / V. Yu. Strel'nikov, I. H. Brytchenko. Poltava: PUET, 309 s.
12. Stryuk A. M. (2015) The use of cloud technologies in the combined education of computer science students of engineering specialties / A. M. Stryuk, M. V. Rassovyts'ka. *Bulletin of the Alfred Nobel Dnipropetrovsk University. Series: Pedagogy and Psychology*, no 1 (9). Pp. 221-226.
13. Varnaliy Z. S., Krasil'nyk O. V., Khmelevs'ka L. P. (2017) Finansuvannya derzhavnykh vyshchykh navchal'nykh zakladiv Ukrayiny [Financing of state higher educational institutions of Ukraine]. Kyiv: Znannya Ukrayiny. 231 s.
14. Wheeler S. Teaching & Learning in the Information Age. URL: <http://www.slideshare.net>
15. Yashchuk T. A. (2017) Systema vyshchoyi osvity v Ukrayini ta yiyi finansuvannya [The system of higher education in Ukraine and its financing]. *Global and national problems of economy*. № 17. Pp. 784-787.
16. Grytsenchuk O. O. and etc. (2012) Information and Communication Technologies of Education in the System of General Secondary Education of Foreign Countries: the Teaching Method. Tool. Kyiv. Pedahohichna dumka, 176 s.

Lesia Syniavska

Doctor of Sc., Full Professor,
Odessa I.I. Mechnichov State University
Odessa, Ukraine
orcid.org/0000-0002-6748-8210

Hanna Truba

Ph.D. in Philology Science, Associate Professor,
Odessa I.I. Mechnichov State University
Odessa, Ukraine
orcid.org/0000-0001-9944-0476

THE LITERARIFICATION. THE MAIN FEATURES AND CHARACTERISTICS OF THE PHENOMENON

Abstract. *Given the history of the study of drama as a kind of literature, scholars distinguish two approaches to its study: theatrical involves the study of a dramatic work, regardless of its stage interpretation, which will be the subject of our study. and literary. Defining drama as utterance that takes into the account of the drama, theatrical and literary nature of drama, the last point at the end of the XIX and beginning of the XX centuries is one where literary trends dominate over dramatic and theatrical ones. The "literarification" of dramatic texts in the new communicative strategy of drama, evidence of its new cultural perception is an attempt, the ability to create a new picture of the world through the prism of literary prototypes based on well-known literary texts, with a base of new formative, text-creating experimentation. The communicative strategy of "literarification" contributes to the expansion of the subject and problems of the dramatic word development. The communicative strategy "literarification" provides textual changes to the repertoire of dramatic texts, Ukrainian theaters. The communicative strategy of "literarification" makes the connection of the dramatic texts of Lesya Ukrainka with the literary world and theatrical tradition, which is reflected in her theoretical studies on the history of Ukrainian dramaturgy, the transformation of dramatic genres in Ukrainian and world dramaturgy in the context of literary trends and styles.*

Introduction.

During the interest of researchers in the phenomenon of communication, although it has been the subject of interdisciplinary knowledge for a long time. Communication is studied in linguistics, biology, pedagogy, political science, psychology, sociology, philosophy, literary studies, which makes it important to clarify the terminology, compare different approaches, common and distinctive features. Drama, as a genre of literature in which the characters, their characters and views, relationships, contradictions and conflicts are manifested primarily in personal and partly authorial speech, is a very interesting object of analysis in terms of communicative studies. The speech of the character in the drama is valuable, because it expresses the intentions of the speaker (and the author behind it). Thanks to the word / speech, the recipient (the reader of the drama, and in the theater in recent decades there will be an increase in the task of identifying the spectator) is able to understand the work, and only then there will be artistic communication, for which the work of art is created. If such an ability is realized, then and only then will the artistic communication take place, for which purpose a work of art, in our case a dramatic work, is actually created. A dramatic word, a statement, first of all, is multifunctional and two-dimensional, it is a means of influencing and achieving the communicative goal of one character in relation to others, another, but at the same time it is a means of influencing and communicating the author with the reader / viewer.

Drama is characterized by special space-temporal conditions for the perception of events, which are equally relevant for both processes: reading and staging. When the nature of the drama interpretation has been changed, the perception of thematically artistic parameters, of the genre nature, also has substantially changed due to the theater plays. "Literarification" is an ability, an attempt to build a new picture of the world through the prism of literary prototypes based on well-known literary texts, which became the basis for formal experiments of new text formation. "Literarification" destroyed the classic permanent canon of genre forms, methods of text formation, plot-compositional techniques. It led to alienation, absurdity, aggression in relation to the tradition of perception of classical works, the eclecticism of a work of art, gives impetus to the emergence of new aesthetic trends and trends – avant-garde, impressionism, symbolism, and subsequently postmodernism. Self-esteem of the communitarian strategy "literarification", in our opinion, is a dramatic scene of sketches about metaphorical, schematic.

1. Narrative tendencies in XX century

At the beginning of the XX century the narrativation tendencies in drama inherited from narrative genres are spreading. This process of using widespread within the dramatic text of the techniques and examples inherent in the epic work can be called, following by A. Chirkov [2], the drama literarification. This emphasizes on the advantage of drama as a work of art, exists simultaneously in two artistic dimensions – literary and theatrical principles. This opinion is also emphasized by the words of Les Kurbas, the head and the founder of the Berezol theatre, that in the 20s of the XX century "took possession of the theater" and "killed it and the actor" [5, p. 35-49]. To define this concept, we use the definition of A. Mikhailov, who understood the tendency to "compose" material according to laws higher than the law of the material itself – "lyrically transform", to transform material, to raise it above a literal value to a higher level" [18, p. 346].

In the literature of the indicated period in general and in dramaturgy in particular, poetological literature is gaining rapid popularity, indicating a self-reflection. The formalist school, which is gaining extraordinary popularity precisely at this time, is trying to determine the essence of the concept of literature. However, its precariousness, instability does not give the possibility of a complete and comprehensive definition of it. Therefore, formalists introduce the concept of literature, which is used to analyze text, in particular fiction [18]. From the formalists point of view, literarification is such a feature of a text that turns it into a literary text, that is, the ability of a literary text to use language opportunities in all its diversity and richness. It is in a literary text, in contrast to everyday communication, that speech demonstrates all its capabilities thanks to literature.

2. The literarification as the communicative strategy

The communicative strategy of "literarification" Ukrainian drama has not been the subject of special scientific research yet. Single observations are contained in the writings of I. Denisyuk [3], V. Pogrebennik, A. Chirkov [2], L. Kurbas [6], but there are no special studies of this trend. The term "literarification" was used by I. Denisyuk in the study "The Development of Ukrainian Small Prose of the XIXth - Early XXth centuries" for the first time [3], where it was used for describing process in folklore texts in prose works of Ukrainian authors, in particular, short stories of the second half of the XIXth and early XXth centuries.

V. Pogrebennik in his studies speaks of "the artistic assimilation of folklore" [6]. Using the favorable thoughts of I. Denisyuk, V. Pogrebennik, we note: The "literarification" is an essential sign of theater texts luminaries, and subsequently other Ukrainian playwrights of the late XIX century.

In our opinion, it is precisely the communicative strategy of “literarification” that leads to textual changes in the repertoire of Ukrainian theaters, to the expansion of the subject and problems of dramatic texts of new literature from I. Kotlyarevsky to the turn of the XIXth – XXth centuries, the emergence of new heroes, of course, due to social and cultural changes in the life of Ukrainian society. In this regard, the problem of literary mimesis is not reduced to a realistic imitation of reality in a dramatic text. Neither M. Kropyvnytsky, nor M. Staritsky, nor I. Karpenko-Kary, followed the reality in the plays, but tried to interpret, psychologize, subjective, i.e. transform. They are still having a fairly strong connection with the folk tradition, it turns out to be at the thematic, textual level. In addition, an attempt is made to dramatize romance-whistle forms, in particular Gogol's prose works.

At another level, the problem of “literarification” was realized in Lesya Ukrainka’s dramatic texts. The pronounced pricelessness of the poet's plays is the implementation of the communicative strategy of “literarification”, a manifestation of the author's attitude to reading these plays, and not a stage embodiment. In our opinion, it is the “literarification” strategy that explains the innovative functioning of the poetic word in dramas by the writer. “Literarification” makes a close connection of Lesya Ukrainka’s dramatic texts with the world literary and theatrical tradition, which is reflected in her theoretical studies and on the history of Ukrainian dramaturgy, the transformation of dramatic genres in Ukrainian and world dramaturgy in the context of literary trends and styles.

3. Literature and theatrical polemics of the late XIX - early XX centuries

This process was reflected in the works of M. Voronoi, Les Kurbas, V. Meyerhold and brought the Ukrainian theater to a new level [17]. In the works of the above-mentioned authors, the principles of the “new theater” are declared, and it should not be guided by folklore ethnographic themes, traditional melodramatic plots from the life of the Ukrainian village. But it should be mastered and creatively rethought the world tradition, fit Ukrainian dramaturgy into the world context, rethink and interpret in new artistic style forms and methods of life and characters whom reality gives birth to. An attempt is made to intellectualize theatrical performances, focus on G. Hauptmann’s “new drama”, and psychologize the characters. In fact, the Ukrainian drama of the second half of the XIX century, thanks to the “literarification”, departs from folklore-ethnographic themes and plots, traditional genre-genre forms and stereotypical characters. However, this does not mean a complete break with the folk tradition. The communicative strategy in dramatic texts of the indicated period realizes itself at the level of adaptation of traditions, a new stage interpretation of folklore texts in plays of the “luminaries’ theater”, in stylization of Lesya Ukrainka’s dramatic poems, the rigor of the poetic word. This stage, in our opinion, represents the first step in understanding and research strategy.

4. Formalist point of view on the process of literarification

In a completely different way, “literarification” appears in Ukrainian dramaturgy of the 10-20s. XX century. In our opinion, the basis of literary analysis of Ukrainian dramaturgy 10-20s XX century. Formalist’s method was one of the most in the theory of literature of the XX century. Let single out the thoughts of formalists, who, in our opinion, are of vital importance in understanding of the problem. Based on the “Poetics of Plots” by O. Veselovskiy [16]. Formalists gave their definition of “motive” and “plot.” It is important for us that the scientists considered the “plot” not at the thematic level, but as an element of “composition”, that is artistic organization of the material. In the subject of research analysis in formalists, there was a mismatch between the sensation of the material process and the possible being in reality. It follows: the work differs from objects, objects differs from reality by a special “convention” (V. B. Shklovsky) [13], (R. Jakobson)

[4]. "Literarification" formalists understood as a "system of techniques "that ensured" the conversion of speech into a poetic work". This transformation, the transformation led to the fact that real "position, conditions" were freed from their real relationships and influenced each other "according to the laws of this artistic linkage" [4, p. 132].

So, based on a formal approach to the formation of requirements for ensuring readiness for work: the modes and modes necessary for the preparation of texts, forensic policy, an ideal thematic focus, to each other, to any specific text. Recognition in the concept and idea of creating significant and practical texts of Ukrainian playwrights 10-20s of the XX century.

The dramaturgic performance often went into the production of "Theater in the Theater" to show artistic space per hour, on the stage of S. Cherkasenok, V. Vinnichenka, Y. Mamontov, L. Staritsko-Chernyakhivsko, G. Khotkevich more and more. The providence of the genre meant that life expectancy would not be a comedy. Its character was changed by Yu. Lipa, I. Poker, Olexander Oles, E. Krotevich all of them worked into internationalism trend, based on creativity, dedicated to the work of dramatic creativity of 10-20's pp. XX century and prepared a new aesthetic strain of Ukrainian literature appeared - avant-garde.

Absurdity, mockery, grotesque, review, permission to participate in the competition of new creative abilities, creativity of the Ukrainian language, such as M. Gogol, I. Nechuy-Levitsky, I. Karpenko-Karyi. Awareness of illustrious, outstanding creative works on copyright issues and dramatic texts, experimental films on the formation of pink theaters before going to school, brothers and sisters. Moreover, an important role in this matter is that it has an address, and where it is located, and in what position. With the appearance of the author's position on fiction and dramatic text: text for readers and scenes for the public. The nature of the communication was appreciated by the author and recipient to express themselves.

5. The communicative strategy of "literarification"

The communicative strategy of "literarification" from alienation, expulsion, alienation and other artistic techniques demonstrates the authorial power over the created world directly and indirectly. The words in the drama are related to the subjectivity, and the actualization of literary and theatrical conventions are clearly noticeable in the dramaturgy of M. Kulish, I. Kocherga, Y. Mamontov, M. Irchan, and Y. Lipa, where the author's tendency is in style and composition. From the point of view of the communicative strategy of "literarification" the author is a creator, a demiurge who interprets traditions in his own way, plays with it. But the author is not only the creator, he is also the narrator, who gives roles to his characters, who perform an allegorical function.

In his theatrical articles, M. Voronoy also noted that the nature of the adaptation of prose plots to the dramatic embodiment at the end of the XIX century is not only conveyed the author's preferences and technical requirements of the scene, but also acquired the character of interpretation [17]. N. Malyutina in the study "Ukrainian dramaturgy of the late XIX - beginning of XX century aspects of genre-genre dynamics" observed: "A certain "literarification" melodrama is traced, and as a consequence parodic involvement in the constant literary forms through the" superstructure "of farce, tragedy, the re-enactment of the novel-story plots acquired the character of imitation or stylization of fantastically mystical conventions or heroic pathos, of the theater-farce acting of the plot, finally, it is a parody of ironic travesty or transposition of the well-known plots" [7, p. 114]. The researcher's remarks seem to us justified, because "literarification" causes the fact that the subject of reference is not reality, but plot clichés, which, in their turn, lead to the destruction of conflict and the emergence of new genre forms - such as dramatic sketches, scenes, paintings, drawings, etc.

The growth of narrative of the drama at that time was noted by academic scientist L. Moroz. In her opinion, this leads to the erosion of the genre factors of the drama [10, p. 192]. The "literarification" of dramatic texts of a certain period is also manifested in the discussion of a considerable number of problems that are not solved by the limited artistic space, and in the presence of a large number of characters, the absence of the main character, resulting in a violation of the sign of the centrality of the plays, which leads to a decrease scenic work. The communicative strategy of "literarification" of the dramatic texts of the 10-20s. XX century manifests itself at the level of conflict. In our opinion, S. Mikhida's observation on the dramaturgy of V. Vinnichenko refers to many plays of this period: "The absence of a through mentioned conflict, which would organize all the work, make it holistic." [9, p. 60]. Those insolubility, incompleteness of the conflict lead to a conditional circumscription of the action, the disappearance of the conflict in general, which lead to the epiphany of the drama, the openness of its finale, and this is also a fact of the communicative strategy of "literarification".

In the study "Epic Drama (The Problem of Theory and Poetics)", A. Chirkov rightly summarized: "... epic drama, based primarily on the experience of epic drama, makes extensive use of techniques inherent in narrative genres. This process is widely used within the dramatic art of techniques. and the principles inherent in epic creation can be tentatively called the literarification of drama, emphasizing this enhancement in drama as a work of art existing simultaneously in two artistic planes (literary and theatrical). First of all, a literary element" [2, p. 127].

Thus, the reinforcement of the epic element of the dramatic texts is another manifestation of the communicative strategy of "literarification" plays of Ukrainian playwrights of the period under study, which has become an advantage of literary tendencies and ideas. Literary mimeticism rather than dramatic prevails in the dramaturgy of that period. In addition to the strengthening of the epic component, the dramaturgy of Alexander Oles, L. Staritskaya-Chernyakhovskaya, Yu. Lipa, B. Grinchenko is quite noticeable literarification. She, in turn, has led to the creation of a lyric drama, which acquires signs of elegance, visibility, pathos, sensuality. In the dramatic works of these authors are distinguished features of lyrical artistic thinking - "chronotope of the moment of personality", that is, a way of subjective experience of a fragment of being. The lyrical primal manifests itself in the symbolic-suggestive nature of poetic speech, the melodiousness of expression.

6. Communicative strategy in the dramatic genres

In the dramatic genres of these authors, the communicative strategy of "literarification" appears in "polystylistics" (the term A. Schnittke) and is implemented in the text at the level of citation, allusions, reminiscences and adaptation. By the principle of citation we mean "... a scale of techniques associated with ... stereotypical elements of someone else's style" (characteristic melodic intonations, harmonious sequences, formula cadence "that belonged to a different era or a different national tradition). An illusion, according to the composer Schnittke, "... manifests itself in the subtlest hints and unfulfilled promises on the verge of quotation, but without stepping over it." The adaptation technique is "... the translation of someone else's musical text into their own musical language (similar to modern adaptations of antique plots in literature) or the free development of someone else's material in their own manner" [12, p. 143 – 144].

In our opinion, these concepts are of general theoretical significance, because they make it possible to isolate and study the stereotypical microelements of someone else's style, methods of combining their own and someone else's speech when adapting tradition, to observe the development of someone else's material using their own stylistic devices, to reveal direct quotes, pseudo-citations, etc.

In short, polystylistics allows us to explore the use of lyrical genres in dramatic works. The condensed expression of the emotions of the heroes and the monological form of knowledge become a source and a way of realizing a dramatic action. This "musicality", which was inherent in purely lyrical genres, thanks to the strategy of "literary" penetrates the drama.

To summarize, we can say that in the 20s of XX century "literarification" took over the theater. Literary trends, ideas, and mimeticism predominate in drama. With regard to drama, the communicative strategy of "literarification" presupposes not only the problem of interpreting well-known plots, motives, saturating them with new artistic-stylistic, genre-generic forms, but also the problem of staging. The communicative strategy of "literarification" became a textual sign of drama, a new philosophy, a testimony to new perceptions in the development of culture. Communicative strategy of "literarification" of drama to show at the level of genus-genre diffusions, intellectualization of plots, stage interpretation of non-dramatic texts, in the tendencies of composition and literarification of works of Ukrainian drama 10-20-ies of the XX century. The process of "literarification" took place through a dialogue with tradition in both world and national drama at the level of adaptation, transformation of themes, issues, types of expression, author's intention and forms of identification of the author's presence in the texts.

7. The particulars of dramatical thinking of the Ukrainian theatre

From the point of view of "literarification" as a communicative strategy of the Ukrainian drama of the end of XIX the heritage of M. Kropyvnytsky's group of defining signs. V. Stasov's theatrical reflection was useful here. Among the characteristic features of M. Kropyvnytsky's drama it was distinguished the usage of painting techniques, the importance of details, broad generalizations of typical characteristics and circumstances, a number of characters whose masks the author tore, where reality is widely reproduced. The theme of women and their role, despotism in the family [14, p. 612] V. Stasov recorded penetrations into the drama of elements of other types of art, in particular painting, the presence of various genres and genres in the poems of M. Kropyvnytsky.

In our opinion, this destroyed the traditional genre canon of drama, because the desire for a broad image of reality was manifested in the playwright in the controversy of his dramas, the desire to create not traditional genre forms, melodramas, which clearly traces the novel-narrative texture. In addition, starting from the 80s and 90s by M. Kropyvnytsky were resorted to intertextuality. He creatively comprehended the work by Moliere, remaking, redrawing his plots.

The tactics of descriptiveness ensured the implementation of a meaningful communicative strategy of "literarification" and allowed the "completion" of tragic pathos, which gave the melodrama, as noted above, ontological and existential nature. The penetration of novel-narrative factors into the drama due to the above-mentioned strategy destroyed its traditional scheme, composition, modernizes and transforms nature. However, "literarification" ensured the success of communication only at the level of form: This communicative strategy provided a dramatic embodiment of prose plots. As N. Malyutina rightly noted that "the staging of novel-narrative plots acquired the character of imitation or stylization [7]. We should add that M. Voronyi ("Theater and Drama") drew attention to stylization as a characteristic feature of contemporary drama.

The stylization of romantic-heroic pathos becomes the basis of M. Kropyvnytsky's "historical-dramatic adventure", where the plot of the novel by Y. Hrebinka ("Tchaikovsky") was adapted. As the transformation of the content by means of another generic form took place, the peculiarities of communication. Combining the features of melodrama and tragicomedy, M. Kropyvnytsky in the process of adaptation adapted to the ironic obscurity of the comedy of the

situation and the artificial sentimental-heroic pathos. The parallelism of the scene with the renaming of Oleksiy Popovych to Tchaikovsky and the thought of confession and repentance of this sinner, the scribe of Sich, who saved the seagulls from the Cossack element, a parody forms discourse of the play was not in the text by Y. Hrebinky transformed the playwright, compared with the novel, and the finale of the play. The finale was open in the novel, the triumph of evil (Hercyk's death) was emphasized, and the prologue was about the non-heroic death of the last member of the genus. M. Kropyvnytsky focused in the finale on the death of Alexei Tchaikovsky as a hero. So, the plot was transformed by M. Kropyvnytsky into a play with genre features of melodrama, to which the features of tragicomedy were "added", "superimposed", which were not given.

Thus, the means of novelistic composition, which provide and determine the structure of utterances, language parts of the play's characters, elements of epic folklore narrative of thought, reminiscences and allusions to T. Shevchenko's "Kobzar" could be considered as manifestations of communicative strategy of "literarification". This testifies to the pioneering nature of the drama by M. Kropyvnytsky, one of the bridges of the transition from traditional realistic theater to modernist theater.

Literature of plays by I. Karpenko-Kary implemented a communicative strategy of "literarification", which was embodied both at the structural-compositional and figurative and thematic levels. This idea was convincingly illustrated by the dogs in the plays "The Master" («Хазяїн») and "One Hundred Thousand" («Сто тисяч»). In particular, "The Master" («Хазяїн») (directed by P. Saksagansky in Kisva in 1900) seemed "non-scenic". The author deliberately avoided bright signs, manifestations of theatricality in the play, as comic scenes and situations. He was more interested in understanding the meaning of life by such masters as Terentiy Gavrilovich. The author wrote in vain: "This comedy is very serious and I am afraid that it will be boring for the audience, which expects only laughter from the comedy" [1]. Translating the meaning of the play from the social-domestic to the existential, philosophical-ontological plan, the author gave it a different sound and meaning. This was no longer just a ridiculous, comic story of a bubble that made money for money, but, as it was fair, in our opinion, said T. Sverbilova, "the story of the suicide of a strong", "true moral guidelines of humanity" [15, p. 23]. The theme of the search for the meaning of life, which was usually characteristic of the intelligentsia, was transferred to the Ukrainian man, who in his fanaticism had confused the populist discourse and was superimposed on the "rural plot". Such eclecticism, layers indicated the author's desire to join the general cultural and in particular the literary process. Thus, we state that due to the communicative strategy of "literarification" the play of the representatives of the "theater of luminaries" was interpreted as a transitional phenomenon from realism to modernism due to structural and compositional changes, updating themes, transformation of the image system.

Conclusions.

In the 20s of the XX century literature "took possession" of the theater. In dramaturgy, literary trends, ideas, and mimetism predominate. Regarding the drama, the communication strategy of "literarification" involves not only the problem of interpreting well-known stories, motifs, saturating them with new artistic-style, genre-generic forms, but also the problem of dramatization. The communicative strategy of "literarification" had become a text logical sign of drama, its new philosophy, and its new perceptions in the development of culture. The communicative strategy of "literarification" drama manifested itself at the level of genre-diffusion, intellectualization of plots, the stage interpretation of non-dramatic texts, and the trends in the epicization and lyricization of works of Ukrainian dramaturgy of the 10-20s XX century. The process of "literarification" took place through a dialogue with tradition both in world and in national drama at the level of

adaptation, transformation of themes, problems, types of utterances, author's intention and forms of manifestation of the author's presence in the texts.

Communicative and human life, relevant studies of different types and methods of communication, the study of types of expression, the peculiarities of their functioning in the communicative paradigm. We studied communication with the help of artistic texts, works of art, for example, literary communication, in particular such a kind of scenography, costumes of heroes, play posters, musical accompaniment, the exterior of the auditorium.

Having analyzed the following characteristics of the dramatic text: narrative as a process that permeates the dramatic, which includes not only the text of the work, but also existing models of communication, resulting in the characteristics of the addressee, represented by the figure of potential and internal author acting as a function or creator; the text as an expression that perceives, condenses, transforms information with, extended in time and space, capable of interpreting and creating new meanings by means of the game principle of reflection of reality, will ensure the perception of information by the addressee.

On the basis of achievements in the field of drama of literary critics, theater critics, communicators the communicative strategies of the Ukrainian drama of the specified period were investigated and their typology was offered. Communicative strategy was defined as the author's intention to organize the expression, planning the discourse of the work of art for effective perception by the recipient. Defining a dramatic text as a work of art, characterized by the unity of content and form, we distinguish two types of communicative strategies:

1. Communicative strategy of the experiment at the level of form;
2. Semantic communication strategies.

Having studied artistic communication as a kind of communication in general, we identified its characteristic features, such as:

- anthropocentrism,
- aesthetic influence,
- the multiplicity of interpretations of the text, which reproduces the quasi-reality,
- the semantic set of the text.

The nature of the type of artistic communication could be determined by the literary genus-species ratio, creative methods of the author, structural schemes of organization of the message in the artistic text. The nature of communication in a dramatic text is multilevel, both internal (between characters) and external communication (between the addressee and the addressee), with multifaceted, and the text is not homogeneous. Dramatic text as an expression of analysis occurs in several stages at which the internal textual communication strategies are implemented, as well as such strategies of communication between the author and the viewer.

As a result of the research it was established that the text in the process of artistic communication entered into a correlation in the communicative act with both the author and the reader / viewer and was influenced by tradition and literary reality. In artistic communication, dramatic text was represented by two forms of submission to the addressee (oral and written). Structurally, it was divided into primary and secondary in the written version.

Artistic communication in a dramatic text was defined as an internally communicative system, and the text itself as a multifunctional metatext, a link in the communicative act between the addressor and the addressee. Today's level of development of the theory of communicative studies had necessitated the establishment of regularities in the functioning of nonverbal components of communication and the identification of coordination with the verbal component of communications.

Non-verbal components of communication are inherently heterogeneous signs that share various, sometimes even opposite in content features. Macro-interaction of verbal and nonverbal components of communication in a dramatic text takes place in the process of constructing abstract dialogic cues with the help of a nonverbal component. Nonverbal components of communication were defined as a communicative strategy of the character's behavior during the communication process (works by Lesya Ukrainka, V. Vynnychenko). Nonverbal components of communication actualized the intrinsic motive of the game, which transforms the genre nature of communication components, which were quite important in L. Starytska-Chernyakhivska. Non-verbal components of communication actualize the intratextual motive of the game, which transforms the genre nature of dogs and provides a strategy for successful communication with the recipient by decoding non-verbally presented information. To the nonverbal components of communication, which were quite important in the structure of the dramatic text. The structure of the dramatic text included remarks that define the text in the text, which will provide a communicative strategy of stage and success of the work. Remarks were structurally and thematically heterogeneous, so we classify them into groups:

1. informational;
2. descriptive;
3. technical;
4. cohesive (provide the linking parts of the text). 1

Information remarks define the author's concept and position, indicate the genesis of the action. Of this plan, synthetic remarks are meaningfully and compositionally more important than individual dialogues of play.

Descriptive remarks indicate the nature of the fictional world in the text of the play. The modality of the descriptive remark is the communicative strategy of the author's presence in the text and ensures the success of the communication of the text with the addressee.

Technical remarks relate mainly to the design of the stage space, addressed to the director, actors, they are diversified, so they indicate the emotions and feelings of the speaker, the addressee of speech, the peculiarities of verbal influence, acoustic remarks, remarks "zero" speech action. These remarks are interpreted as stage instructions for acting. Technical remarks with remarks denoting the nuances of the character's behavior, movements of his body, have communicative or psychological relevance and they are able to reproduce nonverbally in the acting, gestures, facial expressions, articulation with the help of signs of another semiosphere. and remarks-descriptions, verbalizing.

Cohesive remarks connect the parts of the play in the middle of the whole fabric of the text. This type of remarks were significantly transformed in Ukrainian dramatic texts of the late XIX-early XX century, ensured the implementation of a communicative strategy of transformation of the form of the work, which eventually leads to influences, views, gender and genre diffusions, updating the genre system. In the poems of the late XIXth and early XXth centuries, literary tendencies gradually began to prevail over dramatic and theatrical ones. Therefore, the new communicative strategy of dramatic texts of this period with "literarification" as an attempt to create a new vision of the world through the prism of literary prototypes based on well-known literary texts that were based on text-forming and form-setting experiments. The "luminaries" of the theater due to the above communicative strategy with a transitional phenomenon from realism to modernism, because in them we could observe the transformation of the image system, the weakening of ethnography, the deepening of psychologism. In Lesya Ukrainka's dramatic works, text-making changes had been singled out, so that strategies of "literarification" would be included in the world literary-theatrical context.

The strategy of "literarification" refers to the nature of the text, where symbolism and mood are defined as the main textual characteristics. We have carefully analyzed the category of the addressee of the new drama of the turn of the century, which is not only the author, but also combines functions with the manifestation through which the author's work of director, screenwriter, actor.

The strategy of "literarification" provides a transformation of drama towards narrative, epic, lyric. These features reduce the scenic action, provide symbolism and mood, constructivist detachment, the author's presence in the text, selectism. Recontextualization as a textual characteristic of the works of J. Mamontov, Oleksandr Oles, and V. Vynnychenko created an artistic convention organized not by dramatic but by epic laws. This organization of the introduction of allusions, reminiscences, quotations arouses the culturological memory of the addressee of the play (in the version of the stage embodiment), it is emphasized that the addressee creates space-time, supertextual superstructure, thanks to various manifestations of intertextuality.

References

1. Bandurka AM, Druz VA Conflictology.- Kharkov: Fortune, 1997.-356 p.
2. Chirkov A. (1988) Epic drama (The problem of theory and poetics). Kiev [in Russian]
3. Denisyuk I. (1999). The development of Ukrainian small prose of the XIX - early XX centuries. Lviv [in Ukrainian].
4. Jacobson R. (1987) Questions of poetics. Moscow. 480 [in Russian].
5. Kurbas L. (1991) Theatrical art. – Kyiv. 35 —45 [in Ukrainian]
6. Kuzyakina N. (1963) Essays on Ukrainian Soviet dramaturgy. - Kyiv [in Ukrainian].
7. Malyutina NP (2006) Ukrainian dramaturgy of the late XIX century: aspects of genre-genre dynamics.-Odessa. 352 [in Ukrainian]
8. Mikhailov A.V. (1997) Variants of the epic in the literature of Austria and Germany, Moscow. 346 [in Russian].
9. Mikhida S. (2002) Following in his experiments. Content Dominants and Poetics of Conflict in the Playwriting of V. Vinnychenko: Monograph. Kirovohrad.192 [in Ukrainian]
10. Moroz L. 3. (1991) New realistic drama in Ukrainian literature of the late XIX - early XX centuries. Kyiv. 192-220 [in Ukrainian].
11. Pogrebniuk V.F. (2002). "The Literature" of Innocent Folklore by the Representatives of Realistic Poetry of the End of the XIX - Beginning of the XX Century. Kyiv. [in Ukrainian].
12. Schnittke A. (1994). Polystylistic tendencies in contemporary music I Conversations with Alfred Schnittke.. [in Russian].
13. Shklovsky V. B. (1983). On the theory of prose. Moscow [in Russian].
14. Stebelska A. (2009) "Forest Song" is the heart of Lesya Ukrainka's work. [in Ukrainian]
15. Sverbilova T., Malyutina N., Skoryna T. (2009) From modernism to the avant-garde: genre-style paradigm of Ukrainian drama of the first third of the XX century. [in Ukrainian].
16. Veselovsky A. M., (1989) Historical poetics. Moskva [in Russian].
17. Vorony M. (1989) Theater and Drama: 36 articles. Kyiv [in Ukrainian].
18. Zhirmunsky V.M. (1977) On the question of the "formal method" Leningrad. Science, 94-105 [in Russian]

Oksana Beryslavska

PhD in Law, Associate Professor of the Military Law Department

Military Institute of Taras Shevchenko National University of Kyiv, Ukraine

Viktor Dobrovolskyi

PhD in Physical Education and Sports, Colonel Chief of the Faculty of Postgraduate Education

Military Institute of Taras Shevchenko National University of Kyiv, Ukraine

Igor Tolok

PhD in Pedagogical Sciences, Associate Professor, Major General

Chief of the Military Institute of Taras Shevchenko National University of Kyiv, Ukraine

DISTANCE LEARNING TECHNOLOGIES FOR TRAINING SPECIALISTS IN THE CIVIL-MILITARY RELATIONS PROGRAM: OPPORTUNITIES AND PROSPECTS

Abstract. *Based on the experience of specialists in civil-military cooperation, it has been established that they are actively sought-after specialists both in conflict situations and in the post-conflict settlement period, as well as for performing complex non-military tasks. Therefore, the educational component of the Civil-Military Relations program has as its goal the training of specialists capable of solving complex specialized tasks and practical problems, including through the use of effective communication tools. Opportunities for achieving these goals are: educational activities for the development of communicative competence of security and defense sector specialists; international communication on issues of international and national security and defense; joint educational programs, including for acquiring practical skills in the development and implementation of national security policies in various spheres of life of society and the state. It is determined that in modern conditions distance learning is a promising direction in the development of the educational process. A relatively new and actively used direction is also the use of "gamified" education, which is built according to the scheme: receiving a task – completing a task – moving to the next level. To improve the quality of education under the Civil-Military Relations training program, we consider it most appropriate to use blended learning, which introduction will allow to fully realize the potential of higher military educational institutions and use the best practices of the lifelong learning system. It has been argued that the opportunities for access to information resources under the NATO Defence Education Enhancement Programme (DEEP) and the Ukraine-NATO Professional Development Programme (PDP), as well as information resources of other educational platforms are appropriate for the formation of "soft skills" as the most demanded competencies for modern professionals.*

Introduction

The strategic course for full membership in the EU and NATO was enshrined in the Constitution of Ukraine in February 2019. This was done to ensure the irreversibility of the path chosen by the Ukrainian people, for which we continue to pay the highest price. And although Ukraine is only at the beginning of its path to the EU and NATO, we can confidently say that for the first time in Ukrainian history, the issue of full membership in these organizations is not a dream, but an understandable goal and practical task that is already being implemented in practice [7, p.1]

In a situation of complex and multidimensional threats in the modern world not only the Armed Forces of Ukraine but also the authorities and local self-government, as well as educational institutions and civil society institutions must consolidate efforts to resist and recover in case of crises and / or emergency situations. That is why, we believe that securing the course towards Euro-Atlantic integration is an effective step on the way of development and professional growth which should become the key to systemic reformation of the security and defense sector of Ukraine.

Given this, an important factor is the intensification of international cooperation in the field of education with leading countries of the world and the relevant structures of NATO member countries, the intensification of the participation of personnel in international exercises, training missions, trainings, educational programs, consultations, internships and other events, primarily within the framework of the NATO Defence Education Enhancement Programme (DEEP) and the Ukraine-NATO Professional Development Programme (PDP) with the involvement of relevant trainers and teachers for that.

That is why the necessary task is to improve the methodology for developing training programs and training courses (including the possibility of distance learning) within the framework of the Civil-Military Relations program, taking into account the development of leadership skills aimed at creating high motivation and achieving the planned results while studying. Also relevant is the issue of developing gender competencies in the educational process, in particular because gender equality is important for the fair, sustainable and effective development of both education according to European criteria and our country as a whole.

1. Using the capabilities of NATO-Ukraine PDP to train specialists in the Civil-Military Relations program

In order to assist training the civilian personnel of institutions of the security and defense sector of Ukraine, capable to implement and fulfill systemic state reforms in their official activities, under an unified program, in October 2005 during the Ukraine-NATO high-level consultations (Vilnius, Lithuania) the Ukraine-NATO Professional Development Programme (here in after – PDP) was founded. [3, p.1] In 2016, a systematic implementation of the Integrated NATO Assistance Package for Ukraine was launched, a rather complicated mechanism, the functioning of which requires the clear coordination of all government bodies. In order to use the funds effectively, the affectivity of the trust fund for changing the military career to a professional civil one and the Professional Development Program (PDP) have been increased due to the introduction of management subordinate to the Commission for the Coordination of Euro-Atlantic Integration. There was constant communication with NATO member countries to fill NATO trust funds, and to bring aid programs in line with the needs of Ukraine. [7, p.17]

Since 2017, the third stage of PDP has been implemented in Ukraine. [1, p.23] The main objectives of PDP are:

- Carrying out high-quality and specialized training and development activities to meet immediate needs and ensure sustainable results.
- Support in building local capacity for professional development in the security and defense sector.
- Facilitate the establishment of interagency dialogue and partnerships between beneficiaries in order to strengthen cooperation on issues of common interest.
- Assistance in providing bilateral and multilateral assistance from NATO member countries to support the professional development of security and defense sector representatives.
- Establishing cooperation with international and local actors in order to increase the effectiveness of joint efforts to provide training in accordance with the policy of the program. [6]

The main task of the PDP is to train civilian professionals capable of facilitating the effective functioning of the security and defense sector and the public administration system in order to strengthen civilian control over law enforcement and defense structures and to increase their capacity. [1, p.22]

In accordance with the Annual National Program under the auspices of the NATO-Ukraine Commission for 2019, this task is consistent with Objective 1.6.1 *Joining NATO* and Objective 2.1.2. *Professionally trained specialists of the security and defense sector of Ukraine* and can be implemented by increasing the level of professional competence of civil servants and local government officials on Euro-Atlantic integration. [4]

The main executor of the PDP is the Government Office for Coordination of European and Euro-Atlantic Integration of the Secretariat of the Cabinet of Ministers of Ukraine, and the co-executors are the National Agency of Ukraine for Civil Service Affairs and the Ministry of Foreign Affairs of Ukraine. The PDP also includes such educational institutions as the Diplomatic Academy of Ukraine named after Hennadiy Udovenko, the National Academy of Public Administration under the President of Ukraine, the National Institute for Strategic Studies under the President of Ukraine, the National University of Defense of Ukraine named after Ivan Chernyakhovsky and others.

For example, the experience of the National Academy of Public Administration under the President of Ukraine, where the passport of the project "Implementation of the NATO-Ukraine Program for Professional Development of Civilian Personnel in the Security and Defense Sector of Ukraine" was developed, is aimed at raising awareness of civil servants and local government officials in foreign, security and defense policy of the country, in particular security challenges and threats in the regional and transatlantic dimensions, as well as their acquaintance with the work of special security services and agencies. [2, p.2]; [3] It should be noted that this goal reflects one of the key objectives of the Annual National Program under the auspices of the NATO-Ukraine Commission for 2019, namely: to increase the level of professional competence of civil servants and local government officials on Euro-Atlantic integration. In addition, the Annual National Program identifies priorities under the PDP, such as: improving English language skills of personnel to be involved in NATO cooperation activities; raising the level of professional competence of security and defense sector specialists of Ukraine on defense budgeting issues; increasing the level of professional competence of civilian personnel in the security and defense sector of Ukraine within the framework of the NATO - Ukraine Program [4]. According to Anastasia Mishkina, Deputy Head of the NATO-Ukraine PDP, today the main projects of the program are:

- 100 Champions – a project on professional development in the field of Euro-Atlantic integration of civil servants of more than 55 ministries and departments, implemented on request and jointly with the Government Office for European and Euro-Atlantic Integration of the Cabinet of Ministers of Ukraine. Implementation period - 3 years, will continue in 2020 in a new format. This is a project to improve the capacity of civil servants developing the NATO-Ukraine Annual National Program;

- creation of an information and training center in the Secretariat of the Verkhovna Rada of Ukraine – a project aimed at introducing its own capabilities for organizing thematic trainings for civil servants – employees of the Secretariat of the Verkhovna Rada based on needs assessment of VRU committees;

- Young UA – a project to develop leadership qualities and practical skills of young talented civil servants who also work in the field of Euro-Atlantic integration.

- creation on the basis of the National Academy of the National Guard of Ukraine and support for the development of the Euro-Atlantic integration department, which complements the classical training of officers and cadets of the National Guard with modern training modules of the Western model. Implemented in close cooperation with Operation UNIFIER led by Canada.

- cooperation with the Ministry of Defense of Ukraine in advanced training of its employees. Employees of the Ministry of Defense and the General Staff of the Armed Forces of Ukraine are participants in many PDP projects.

- creation of the concept of the hub for building the national stability of Ukraine. [5]

It should be noted that the training of specialists in the Civil-Military Relations program also takes into account the main approaches of the PDP, in particular on improving the professional level of servicemen involved in cooperation with NATO and reforming the security and defense sector of Ukraine.

- development of special courses on Ukraine's cooperation with NATO for implementation in higher education institutions of Ukraine (for example, "Public Administration in Armed Conflicts", "Protection of Civilians in Armed Conflicts", "Joint Doctrine of Civil-Military Cooperation", "Law of International security");

- building Ukraine's own national institutional capacity to provide quality, modern and effective training, retraining and advanced training for personnel involved in all matters of cooperation with the Alliance, in particular in the context of Ukraine's preparation for NATO membership (eg foreign language courses; advanced training of specialists of the legal service of the Armed Forces of Ukraine; advanced training courses in the law of armed conflicts, as well as internships and practical training);

- integration of methods and approaches to professional training, retraining and advanced training of civilian personnel of the security and defense sector of NATO member states into the national system of training and advanced training of specialists in the field of Euro-Atlantic integration of Ukraine (for example, study of methods of preparation of strategic documents); taking into account organizational change and planning strategies, approaches to leadership and leadership in public administration, the use of NATO standards such as NATO Allied Joint Doctrine for Civil-Military Cooperation (STANAG 2509); Training in the Law of Armed Conflict (STANAG 2449);

- development of programs of highly specialized targeted trainings / seminars / courses taking into account the needs of state bodies on Euro-Atlantic integration and security and defense sector reform (such programs should address in particular: civil preparedness in case of crises and / or emergencies; non-military security dimensions; overall approach, leadership systems, etc.). [8]

2. Using the distance learning for the formation of "soft skills" in the frame of training specialists on the program "Civil-Military Relations"

Today we consider it extremely important to implement into the educational process advanced methods and pedagogical technologies (distance learning technologies), including those used in the training of the armed forces of NATO member countries and can be adapted to the specifics of training cadets (students) on the program "Civil-military relations".

This is stated in particular in the National Strategy for Education Development in Ukraine until 2021, which among the main areas of implementation provides for the informatization of education, which in turn includes the creation of distance learning system and providing educational process by means of information and communication technologies as well as access of educational institutions to the world information resources [9] and in the Strategic Defense Bulletin of Ukraine (Operational goal 5.2. *Improving the System of Military Education and Training*) [10], as well as in the Concept of Distance Learning in the Armed Forces of Ukraine, which advocates the introduction of continuous phased system of "lifelong" training military specialists as an effective tool for reforming the system of military education. [11]

Learning is about sharing communicative knowledge and skills with a student audience. For instance, Susan Ko and Steve Rossen rightly believe that online courses differ from classroom ones in how we transfer knowledge, the methods we use to facilitate communication, and the opportunities that the new environment gives us. In this case, the goal is to identify these differences and provide the means and methods to share knowledge in the online learning environment. [12, p.76]

In particular, the authors point out that distance education is a method of teaching in which the student and the teacher are physically in different places. It can combine technology, including audio, correspondence, video, computer, and the Internet. While online education is a form of distance education that involves the use of computers and the Internet as a means of transmitting information and teaching at least 80% of the course online. Furthermore, the authors note that there are also hybrid / blended courses – those that use a combination of classroom classes and online learning. In general, a course is considered blended if 30-79% of its content is read online. [12]

The authors of the manual "Technology of creating a distance course" provide two possible options for defining the concept of "distance education". First, distance education is a type of educational system in which distance learning technologies and organization of the educational process are mainly used. Second, distance education – one of the forms of education, in which the mastery of one or another of its levels in a particular specialty (direction of training, retraining or advanced training) is carried out in the process of distance learning [13, p.7-8]

Ihor Kuzmych defines distance learning as a variant of part-time education which is based on the use of a set of modern technologies that provide information delivery through the use of information and communication technologies [14, p.105].

In modern conditions, we consider this approach somewhat one-sided and the one which narrows the possibilities of distance learning and its application in the military education system. We tend to believe that distance education in the military is not a substitute for education in its classical sense, but only a teaching technology.

So, in the study manual "Organization and use of distance learning technologies in the Armed Forces of Ukraine" the authors draw attention to the fact that distance learning technologies can be used in other forms of military training: full-time, part-time and mixed forms of training, retraining and advanced training, as well as in system of individual training during the study of particular disciplines (topics) or blocks of disciplines.

Thus, distance learning is implemented through the use of distance form as a separate form of education or the use of distance learning technologies to ensure the educational process in other forms. It should be clearly understood that the introduction of distance education, which provides for the issuance of a state diploma (after a separate program of practical study and state certification in accordance with the Law of Ukraine "On Higher Education"), requires approval from the Ministry of Education and Science of Ukraine. The use of distance learning technologies to ensure the educational process, as well as retraining, advanced training (postgraduate education) personnel in form of distance learning are carried out in licensed directions of training (within the licensed volume of distance learning) and do not require approval from the Ministry of Education and Science of Ukraine [15, p.3].

There is also a prevailing opinion among the authors that the specifics of training military specialists determine some features of the introduction of distance learning in the military education system. Given this, the educational process of distance learning at the first stage of implementation

can be divided into four areas: -training within the system of military education of military students, civil students (training of reserve officers), specialists for other law enforcement agencies and foreign servicemen; - advanced training and course training of officers of the Armed Forces of Ukraine; - providing servicemen (both conscripts and enlisted ones) with the opportunity to receive distance learning at the expense of the Ministry of Defense of Ukraine (contract terms); - providing opportunities for servicemen of the Armed Forces of Ukraine to receive higher education in distance learning at personal expense [16, p.35].

We believe that in the context of further integration of military and civilian education in Ukraine, theoretical and practical work on the implementation, creation and development of distance learning in the Armed Forces of Ukraine should last continuously, purposefully and productively, in parallel with the development of distance education in Ukraine. In addition, today the requirement of time is to change the forms and methods of teaching, in particular for the training of specialists in the program "Civil-Military Relations".

In our opinion, an additional advantage of the introduction of distance learning is the reduction of costs for the organization and provision of the educational process, the possibility of continuing the educational process in unusual conditions (for example, in the situation with COVID 19), the possibility of "lifelong learning", i.e. gaining appropriate competencies while military service and acquisition of competencies relevant to civilian specialties on retirement from the Armed Forces of Ukraine.

L. Hevlych and I. Hevlych as modern educational trends distinguish the following: lifelong learning, duality, smart education, the formation of soft skills through on-line courses [17, p.188].

In the 80's in the European educational space there was formed an understanding that the high level of knowledge of schools and universities graduates does not guarantee them successful professional self-realization. That is why in 2007 the document "The Key Competences for Lifelong Learning – A European Framework" appeared, which identifies 8 key competencies for lifelong learning, such as: 1) communication in the native language; 2) communication in foreign languages; 3) mathematical competence and basic competences in science and technology; 4) digital competencies; 5) the ability to learn; 6) social and civic competencies; 7) skills of initiative and entrepreneurship; 8) cultural self-awareness and self-expression. [18, p.5]

The term "soft skills" is most often defined as "soft" skills (competencies), but there are other translations, such as human or unified. "Soft skills" is a sociological term that refers to a person's emotional intelligence, a kind of list of personal characteristics that are somehow related to effective interaction with other people. These are skills that are difficult to detect, directly identify, test, and demonstrate. This group includes individual, communication and management skills. The concept of "soft skills" is related to how people interact with each other, is "soft" skills are equally necessary for everyday life and work. According to research, professional success is determined by "soft skills". [19, p.163]

In the context of training military specialists, as well as to some extent civilian specialists for the security and defense sector, it should be noted that "hard" skills (competencies) are related to military professional (special) knowledge, skills and abilities so require a special training regime. It is important to take into account that the information on training for the Armed Forces of Ukraine and other military formations belongs to paragraph 2.7 of the List of official information owned by the state in the field of education and science of Ukraine, approved by the order of the Ministry of Education and Science of Ukraine № 319 on 18.03.2015, section 2 "Defense, economics, education

and state security" [20], therefore – the educational components of the relevant curricula may not be published in the open media.

The authors of the study manual "Organization and use of distance learning technologies in the Armed Forces of Ukraine" also emphasize that the further development of distance learning will lead to the need to create closed communication networks in the Armed Forces of Ukraine, which will allow the use of restricted information. [15, p.5]

From this we can conclude that "hard" skills (competencies) that involve mastering military-special disciplines can't be formed by use open on-line platforms, this is due to the peculiarities of the regulation of military activities and the requirements on special access to them for students. An example to confirm this is the NATO e-Learning platform [21], where to register you need to have an official e-mail from NATO, government or NATO servicemen. If you do not have a military or official government e-mail address, you must have a sponsor from a NATO member or NATO command structure to confirm the possibility of training in the interests of NATO. Thus, the possibilities of distance education in the military sphere are associated with organizational and functional limitations.

At the same time, the CCOE Global e-Learning platform, hosted on the CIMIC Center of Excellence website, which acts as a hub for sharing collective knowledge, communicating people and achieving unity of purpose in civil-military interaction, offers a number of courses to expand competencies and acquisition of tools that can be used in future careers. Such courses include: NATO CMIC / CMI Awareness Course (NCAC: Advanced Distributed Learning / ADL); NATO CMI / CIMIC Orientation Course (NCOC); NATO CIMIC FIELD WORKER COURSE (NCFWC); NATO CIMIC STAFF WORKER COURSE (NCSWC); NATO CMI / CIMIC HIGHER COMMAND COURSE (NCHCC); NATO CIMIC LIAISON COURSE (NCLC); NATO CIMIC Functional Specialist Course (NCFSC); NATO CIMIC / CMI Integrated Functional Specialist Course (NCIFSC); UN-CM COORD eCOURSE (facilitator led); Master of Civil-Military Interaction (M-CMI). [22] All of these courses are paid, the cost of the course depends on whether the student is a representative of the sponsoring country CCOE (Denmark, Germany, Hungary, Latvia, The Netherlands, Poland, and Slovenia) or not.

Regarding the use of online opportunities for cadets / students, it should be noted that the Leadership Center of the Ukrainian Catholic University implements the program "Management and leadership in the military unit", a separate module of which is "How to choose a leadership style in a crisis situation." The educational platforms "BYM-online", "Prometheus", "EdEra" and others are also offer some interesting projects. Many of the courses outlined there are designed specifically to develop "soft skills".

Taking into account the possibilities of the PDP program, in particular in the field of dissemination of information about NATO, we can give examples of game projects that are available to cadets / students:

- "100 facts about NATO", a project created in the form of a podcast, which succinctly provides information about the organization, its goals, principles of operation, etc. [23]
- "NATONIA", a project created in the form of an online game, which has levels, each of which includes questions and other interesting information about NATO [24]
- "NATO MAP GAME", a project created in the form of an online game in which you need to find NATO member countries and NATO partner countries on the map [25]

Back in 2015, at the World Economic Forum in Davos 10 professional skills that will be relevant in 5 years, i.e. in 2020 were named. Such skills are: 1. Complex problem solving 2. Critical thinking 3. Creativity 4. People management 5. Coordinating with others 6. Emotional intelligence 7. Judgment and decision-making 8. Service orientation 9. Negotiation skills 10. Cognitive flexibility. [26].

Given the above, we analyzed the open educational platforms to identify courses that can be used to form "soft skills" in the training of specialists under the program "Civil-Military Relations", which is shown in table 1 (developed on the basis of sources [27], [28], [29], [30] by O. Beryslavska).

Table 1. Educational courses for the formation of "soft skills", which can be used to train specialists under the program "Civil-Military Relations"

Educational platform, where the course is located	Course title	Soft skills competencies
Prometheus	How to plan and conduct a dialogue effectively.	Ability to negotiate; complex multilevel problem solving; interaction with people; forming one's own opinion and making decisions.
	Dialogue and mediation: The path to understanding	Ability to negotiate; interaction with people; tolerance; formation of own opinion and decision-making; complex multilevel problem solving.
	Interaction of public authorities with the public	Interaction with people; complex multilevel problem solving; ability to negotiate.
	Critical thinking educational tools	Critical thinking; creativity in a broad sense; flexibility of mind
	Women and men: gender for all	Complex multi-level problem solving; ability to negotiate; interaction with people; tolerance; forming one's own opinion and making decisions
	Information wars	Digital competencies; building an information society
	Media literacy: practical skills	Digital competencies; ability to learn; building an information society
	Digital communications in the global space	Digital competencies; ability to learn; building an information society
	Basics of information security	Digital competencies; ability to learn; building an information society
Educational Era (Ed Era)	Very verified: online media literacy course	Digital competencies; ability to learn; building an information society
	Dialogue and mediation skills for the needs of the public service	Complex multi-level problem solving; ability to negotiate; interaction with people; tolerance; forming one's own opinion and making decisions
	Ukraine-EU Association Agreement	Cultural self-awareness and self-expression; flexibility of mind; ability to learn; understanding of the world context
	European mechanism of human rights protection.	Cultural self-awareness and self-expression; flexibility of mind; understanding of the world context; ability to learn

BYM-online	<i>About NATO</i>	Understanding the global context; cultural self-awareness and self-expression; flexibility of mind; ability to learn
	Human rights in action	Cultural self-awareness and self-expression; flexibility of mind;
	Introduction to mediation	Complex multi-level problem solving; ability to negotiate; interaction with people; forming one's own opinion and making decisions
	School of effective thinking	Critical thinking; creativity in a broad sense; flexibility of mind; personal effectiveness
	<i>Critical thinking</i>	Critical thinking; creativity in a broad sense; flexibility of mind; personal effectiveness
	<i>Introduction to critical thinking</i>	Critical thinking; creativity in a broad sense; flexibility of mind; personal effectiveness
	<i>Strategic thinking</i>	Critical thinking; creativity in a broad sense; flexibility of mind; personal effectiveness
	<i>Digital security and online communication</i>	Digital competencies, building an information society
	<i>Information security in the digital world</i>	Digital competencies, building an information society
Civicportal.education	Social cohesion and conflict reduction in communities	Complex multi-level problem solving; ability to negotiate; interaction with people; tolerance; forming one's own opinion and making decisions
	For communities about gender in simple language	Complex multi-level problem solving; ability to negotiate; interaction with people; tolerance; forming one's own opinion and making decisions
	How to find out the needs of the community through local analysis	Complex multi-level problem solving; ability to negotiate; interaction with people; forming one's own opinion and making decisions

As you can see, all these skills can be safely attributed to "soft skills". We believe that such competencies are necessary primarily for self-development, and for their acquisition it is possible to use smart education, on-line courses etc.

Conclusions

In our opinion, besides the PDP activities it is necessary to use the experience of NATO countries in training local teachers / trainers, who could further disseminate NATO best practice in leadership, change management and effective communication to the national training, retraining and advanced training system for specialists in the security and defense sector.

Based on the above, the possibilities of achieving these goals are: educational activities designed to develop the communicative competence of specialists in the security and defense sector; international communication on international and national security and defense; joint educational programs, including those to acquire practical skills in the development and implementation of national security policy in various spheres of society and the state.

At the same time, we consider the threats that may hinder the implementation of the PDP to be quite real, such as: the political situation in Ukraine, complicated by the armed aggression of the Russian Federation; lack of understanding by most officials of global security issues and, as a consequence, topical issues in the field of defense and internal security of the country, including at

the regional level; absence of a systematic legal framework for training, retraining and advanced training of specialists in the security and defense sector; insufficient level of financial and resource provision, as the program mostly exists within the framework of specific financial assistance from NATO member states.

The implementation of distance learning in the system of military education, in our opinion, will help attract more participants to the acquisition and continuous improvement of professional military education; more rapid response to changes in modern society and education; providing the brand new educational services through access to information resources, including the formation of "soft skills" as the competencies of the most in demand for modern professionals.

References

1. *European and Euro-Atlantic integration. Transition book.* (2019). <https://www.kmu.gov.ua/storage/app/sites/1/17-presentation-2019/8.2019/transition-book-final-stisnuto.pdf> [in Ukrainian]
2. Passport of the project "Implementation of the NATO-Ukraine Program for Professional Development of Civilian Personnel in the Security and Defense Sector of Ukraine". <http://academy.gov.ua/?lang=ukr&tip=dop&tipn=Page&page=34> [in Ukrainian]
3. Implementation of the Ukraine-NATO Program for the Professional Development of Civilian Personnel in the Security and Defense Sector. Ukraine - NATO 2013-2014. (2013). Natsionalne ahentstvo Ukrainy z pytan derzhavnoi sluzhby. Ofis zviazku NATO v Ukraini. <https://mfa.gov.ua/mediafiles/sites/belgium/files/41400801dod.pdf> [in Ukrainian]
4. *Annual National Program under the auspices of the NATO-Ukraine Commission for 2019: Decree of the President of Ukraine № 117/2019.* (2019, April 10). http://search.ligazakon.ua/l_doc2.nsf/link1/U117_19.html [in Ukrainian]
5. Stepaniuk, O. (2020, March 23). *500 military and civilian personnel are trained each year under the NATO PDP.* Army Inform. <https://armyinform.com.ua/2020/03/500-vijskovosluzhbovcziv-ta-czyvilnyh-praczivnykiv-shhoroku-prohodyat-navchannya-v-ramkah-nato-pdp/> [in Ukrainian]
6. North Atlantic Treaty Organization. *NATO Representation in Ukraine.* (2020, January 22). <https://www.nato.int/cps/uk/natohq/172885.htm> [in Ukrainian]
7. Report of the Vice Prime Minister on European and Euro-Atlantic Integration of Ukraine during his work in the government (2016-2019). (2019). Ofis Vitse-premier-ministra z pytan yevropeiskoi ta yevroatlantychnoi intehratsii. <https://www.kmu.gov.ua/storage/app/sites/1/17-presentation-2019/7.2019/81.pdf> [in Ukrainian]
8. Beryslavska, O. (2019). Program of professional development of civilian personnel as a mechanism for implementing a systematic approach to reforming the security and defense sector of Ukraine. *Viiskova osvita i nauka: siohodennia ta maibutnie: Tezy dopovidei XV Mizhnarodnoi naukovo-praktychnoi konferentsii (pp. 361-362).* VIKNU [in Ukrainian]
9. *On the National Strategy for the Development of Education in Ukraine until 2021: Decree of the President of Ukraine № 344/2013.* (2013, June 25). <https://zakon.rada.gov.ua/laws/show/344/2013> [in Ukrainian]
10. *Strategic Defense Bulletin of Ukraine: Decree of the President of Ukraine № 240/2016.* (2016, June 06). <https://www.president.gov.ua/documents/2402016-20137> [in Ukrainian]

11. *The concept of distance learning in the Armed Forces of Ukraine*: Order of the Ministry of Defense of Ukraine № 744. (2015, December 21). <http://adl.nuou.org.ua/wp-content/uploads/2017/12/conception.pdf> [in Ukrainian]
12. Ko, S. & Rossen, S. *Teaching Online: A Practical Guide*. <http://libgen.info/view.php?id=533126> [in Ukrainian]
13. Bykov, V., Kukharenko, V., Syrotenko, N., Rybalko, O. & Bohachkov, Yu. (2008). *Technology of creating a distance course*. (Bykov, V. & Kukharenko, V. Eds.). Milenium [in Ukrainian]
14. Kuzmych, I. (2017). Management of distance learning in higher military educational institutions in today's conditions. *Viiskova osvita*, 1, 103-107. http://nbuv.gov.ua/UJRN/vios_2017_1_15. [in Ukrainian]
15. Salkutsan, S. (Ed.). (2017). *Organization and use of distance learning technologies in the Armed Forces of Ukraine*. NUOU [in Ukrainian]
16. Tkachenko, V., Hinevskiy, M., Haidarov, S. (2002) Distance learning in the system of military education. *Systemy obrobky informatsii*, 6, 35-39 [in Ukrainian]
17. Hevlych, L. & Hevlych, I. *Current trends of domestic higher education*. <http://jnos.donnu.edu.ua/article/viewFile/6546/6578> [in Ukrainian]
18. Key Competences for Lifelong Learning – A European Framework. Recommendation of the European Parliament and of the Council of 18 December 2006 on key competences for lifelong learning. (2006). *Official Journal of the European Union L 394*. http://eur-lex.europa.eu/LexUriServ/site/en/oj/2006/l_394/l_39420061230en00100018.pdf
19. Koval, K. (2015). The development of "soft skills" among students is one of the important factors of employment. *Visnyk Vinnytskoho politekhnichnoho instytutu*, (2), 162-167 [in Ukrainian]
20. *On approval of the List of official information owned by the state in the field of education and science of Ukraine*: Order of the Ministry of Education and Science of Ukraine № 319 (2015, March). <https://zakon.rada.gov.ua/rada/show/v0319729-15> [in Ukrainian]
21. NATO e-Learning. <https://jatl.act.nato.int/>
22. CCOE Global Learning. <https://global-learning.cimic-coe.org/>
23. 100 facts about NATO. <https://soundcloud.com/natoinukraine> [in Ukrainian]
24. NATONIA. <https://www.natonia.com/>
25. NATO MAP GAME. <https://www.nato.int/multi/nato-map-game/public/index.htm>
26. *Work of the future: 10 skills that will be in demand in 2020*. (2016, November 07). Ukr.Media. <https://ukr.media/science/280897/> [in Ukrainian]
27. The first distance platform of civic education from the Open University of Maidan (BYM). <https://vumonline.ua/> [in Ukrainian]
28. Platform of mass open online courses "Prometheus". <https://prometheus.org.ua/about-us/> [in Ukrainian]
29. Online Education Studio "Educational Era". <https://www.ed-era.com/> [in Ukrainian]
30. E-learning platform: "Civicportal. education". <https://civicportal.education/mod/page/view.php?id=105> [in Ukrainian]

Olha Zavalova

*Doctor of Art (musicology), professor of department Arts, Musicology and Cultural Studies,
Sumy State Pedagogical University named after A.S. Makarenko
<https://orcid.org/0000-0002-9483-5871>*

Oleksandr Stakhevych

*Doctor of Art (musicology), professor of department of Choral Conducting, Vocals and Methods of
Music Training,
Sumy State Pedagogical University named after A.S. Makarenko
orcid.org/0000-0001-9261-4023*

Halyna Stakhevych

*Candidate of Study of Art, senior teacher of department choreography and musical instrumental
performance,
Sumy State Pedagogical University named after A.S. Makarenko
Ukraine, Sumy
orcid.org/0000-0002-5915-2434*

**COMPONENT CONSTITUENTS OF FORMING A CULTURE OF ENSEMBLE
PERFORMANCE IN THE FUTURE SPECIALISTS OF MUSICAL ART**

Abstract. *The role of ensemble music in the process of preparation of future specialists in music art is substantiated. The theoretical and methodological foundations of teaching the ensemble are revealed, the necessity of introducing ensemble play to the educational programs is indicated. The structured system of the basic components of the teaching ensemble play is determined, which influence the quality of formation and development of the student's performing culture. The most difficult components of work with the ensemble: organization of classes, questions of repertoire selection, working out of ensemble and technical difficulties, work on the form and artistic image of the performed work. The dependence of the level formation of performing and technical skills of the student, his experience of playing in different types of ensemble and artistry with the development of personal culture of ensemble music are revealed. It is proven that compatible music offers great opportunities and greatly activates the development of professional skills, solving interpretation issues, the search for expressive means and techniques of the game. Concertive factor of ensemble accomplishment are concert performances, which give the opportunity to develop practical skills of playing in public, greater stage freedom of each participant and their interaction during the performance.*

Introduction

The ensemble performance is an integral part of the education of an experienced musician, his understanding the specificity of performance in the team during the interaction of all participants. The pedagogical and theoretical development of many researchers in music education emphasized that ensemble performance contributes to the development of collegiality, communicativeness, discipline and understanding of the participants [1; 3; 5; 6; 9]. In the XX-XXI centuries, several world-class schools were formed, in which ensemble music was used as a powerful factor in the comprehensive development of musicians at all levels of study. The activities of such schools were based, in particular, on the method of music teaching by Carl Orff in Germany, the method of choral singing Zoltan Kodaly in Hungarian, «El Sistema» by Jose Antonio Abreu in Venezuela, the method of musical development of children Shinichi Suzuki in Japanese and others.

An important role of ensemble music in the process of development of a specialist in music art was noted by such musicians-teachers as G. Dudamel, K. Igumnov, H. Neuhaus, M. Austin, and D. Oistrakh.

The results of their performing and scientific-pedagogical activity prove that the involvement of students or pupils in the ensemble plays contributes to the expansion of the general outlook and musical ideas, the development of independent work skills, the manifestation of creative initiative, deepen the understanding of performing specifics, musical styles, etc. [2]. Many researchers emphasize the powerful influence of ensemble playing on the process of educating the audio culture and the development of the creative personality of the performer. The ability to listen to yourself and other participants of the music collective, to understand the timbre and sound capabilities of the ensemble and to take into account the requirements of sound balance - all this determines the level of «sound space» perception and cultural performing of the musician [8].

Another component of playing in the ensemble is the development of social interaction skills in order to overcome psychological separation and to establish long-term creative relationships between participants of different specialties, which V. Belyanin notes in his research [1, p. 68]. That is precisely at the lessons of the ensemble the culture of professional behavior of future specialists of musical art is also cultivated. It is an ensemble playing that contributes not only to the creative atmosphere and collective responsibility, but also the ability to agree and cooperate, to be tolerant to the opinion of each participant when discussing the interpretation of a musical work, finding options for certain artistic decisions, the choice of performing features, etc.

The active popularization of ensemble music in recent years in the performance and music-pedagogical education of different countries gives grounds to argue that the issue of mandatory introduction of ensemble playing in the educational process of higher educational institutions is an urgent requirement of modern music practice and teaching.

The purpose of the article is to identify the components and pedagogical approaches of ensemble education aimed at shaping the performing culture of future specialists in music art.

At the article solves some organization issues of the educational process in the ensemble class, the use of forms and methods aimed at the formation of performing culture and artistry, the role of independent work in the process of studying and performing ensemble works.

The methodological basis of the article is a comprehensive review based on historical-theoretical, methodological-pedagogical, music-performing approaches to the research of the stated problems. The main methods of work are historical-comparative, structural-functional and theoretical generalization. The structural and pedagogical features of the ensemble are disclosed by means of music-pedagogical analysis.

General methodological provisions of ensemble education.

The development of ensemble playing skills, which is primarily performed in the chamber vocal and chamber instrumental (piano, string, brass, etc.) ensemble, is an important link in the process of teaching students singing, playing piano, string-bow, wind, folk instruments. During ensemble lessons the experience of collective performance is developed, the horizon of musical thinking is expanded, artistic tastes and sound culture are formed, the understanding of style, form and content of the performed works is cultivated, auditory control is activated, the reading skills of the letter are developed and fixed. Therefore, except the required repertoire, it is useful to give small ensemble pieces for students to study individually. An incentive to learn more repertoire may be getting acquainted with world-class samples or novelties of chamber-instrumental or chamber-vocal literature. In the ensemble class, this type of work provides an opportunity to open more student potential, improve his reading skills and speed of learning the musical text, deepens understanding of the musical specificity of different eras and styles.

Ensemble pedagogy is an effective way of musician educating at all levels - from organizational to musical and artistic. Good organization of the educational process, based on strict adherence to the schedule, setting and performance of educational and artistic tasks, is a significant factor that influences the effectiveness of the formation of performing culture in the classes in the ensemble. The cultivation of creative discipline and responsibility in the process of ensemble play is associated with the formation of a sense of team, each participant of which is aware himself as a whole-part. After all, ensemble playing requires the formation of skills to listen yourself and partners, closely follow to the text, to hear and see what others are doing, to learn to subordinate their desires to a collective task, to take into account the colleagues opportunities and feelings. «Disciplinary» requirements are directly related to the artistic and technical principles of compatible music, which include rhythmic consistency of performance, sound and dynamic balance, unity of strokes and phrasing. In general, it requires good professional training of ensembles: mastering the technique of playing the instrument, good sound production, strokes, phrasing, etc.

For better retention and reproduction of musical material and mastery of professional skills, including playing the instrument, in ensemble classes it is necessary to pay attention to the development of certain means of expressiveness, acquaintance with the new repertoire or expansion and rethinking on the new principles of the material, its further gradual expansion and deepening. The effectiveness of the lessons in the class of the ensemble depends to a large extent on the collective work of the teacher and the student, since communication, especially creative, plays a major role in the formation of personality. Another factor that stimulates the process of artistic and creative self-organization of students and influences the creation of their own performance interpretation, using the acquired knowledge and skills, is the independent study of works [4].

Solution of artistic tasks in the class of chamber-vocal or chamber-instrumental ensemble is impossible without understanding of the elements of artistic expressiveness of singing voice and musical instruments by the participants. But its understanding is complicated by the heterogeneity and specific features of sound production on each instrument, which often depends on artistic interpretation, choice of repertoire and expressive means. N.O. Ivanova points out that the knowledge of the instrument and its capabilities, sound features (for example, vibration on stringed instruments, pedaling to the piano, sound filtration of the vocalists) especially affect the performance of the ensemble [6, p. 47]. Therefore, another task that is solved at the lessons of the ensemble is to deepen the knowledge of future musicians about the structure, expressive qualities and capabilities of the singing voice and various instruments, the ability to use their «strengths» and find different approaches to overcome certain artistic tasks.

Overwhelmingly, successes in ensemble music depend on the successful selection of participants, which is emphasized in the article by K. Polyans'ka [9, p. 215]. Thus, when forming the ensemble, it is necessary to take into account the degree of professional training, psychological compatibility of partners, their musical tastes, temperament, even the sense of responsibility of each. Mixing in an ensemble of improper participants' level of training often leads to the problem of selecting a repertoire and evaluating their performance (reducing the overall score of the ensemble or evaluating each participant differently).

With the purpose of best results, the issues of selection of ensemble repertoire are also related. The first and foremost condition should be the choice of works that ensembles can perform. As a rule, chamber-vocal literature or repertoire for violin and piano have a sufficient number of works of different eras and styles of different performing complexity.

But in the selection of ensemble literature for viola or cello, there are always difficulties: the repertoire of these instruments is often too difficult for students. One way to solve the problem is to include such students into a trio or other large ensembles whose parties they can easily perform. In general, when selecting an ensemble program, the opportunities and interests of all participants must be taken into account [9, p. 215]. This is the key to both successful classes and concert performances and the professional development of students in general.

In the process of mastering the skills of ensemble music playing an important role is played by tradition of performing chamber works on music text. Firstly, it allows participants to interact more freely with partners and coordinate activities within the ensemble. Secondly, playing music text largely prevents accidental mistakes and unexpected runtime (pauses and confusion in the text, incorrect harmonies or rhythm) that can lead to unwanted consequences. Thirdly, it provides an opportunity to learn freely follow the text. Performance as an academic concert or exam is a summarizing factor in the quality of the skills acquired and the ability to play in the ensemble. Publication of the concert program is an important element in the process of forming a professional performing culture of ensemble specialists, because during the performance practical skills of artistry are developed that cannot be acquired in the classroom. In addition to academic concerts and exams, a widespread form of public speaking in art education institutions are class concerts, departmental reporting events, various competitions held both at educational institutions and beyond, etc.

The development of artistry as a problem of performing culture is closely linked to the public representation of the ensemble's activities. The active "concert life" of the collective promotes the development of greater responsibility of the ensemble students during the preparation of the performing repertoire, the development of playing skills in the public, the performing freedom of the collective on the stage and the interaction of the participants among themselves. It is during the performance that the main components of artistry are manifested: the ability to connect with listeners, giving a vivid emotional impression; the use of images embodied in musical compositions; the ability to express their own sense of music by different composers without losing its stylistic authenticity [3, p. 11-12].

In addition, performing internships in institute of higher education helps identify ensembles with «strengths» and «weaknesses» that can be further exploited or improved. Thus, during public play, each participant shows skills and experience of psychological stability, the ability to adjust to the creative process and public speaking, to overcome excitement and to develop self-control [7, p. 78-79], which is a necessary basis for the professional activity of music art professionals.

Work specifics with chamber instrumental ensemble.

The study of the specifics of working with a chamber and instrumental ensemble in this work is limited to the compositions of stringed bowed instruments with piano: violin, cello, viola, their combinations in duets, trios, quartets, ensembles of violinists / cellists, etc. This approach is due to the fact that historically works for these instrumental compositions formed the basis of academic ensemble art. Spiritual and very rarely folk instruments, which have their own organic and technological features, timbre nature, principles of intonation, harmonious and textural presentation, which affects the originality of their ensemble qualities and repertoire, were not often involved in this sphere. These issues require a separate study, and therefore are not considered in the proposed work.

Studying in a chamber ensemble class is a mandatory component in the system of professional education of a musician in music education institutions in the post-Soviet space. This is a general discipline for students of string-bow and piano departments, during the study of which they get acquainted with chamber and ensemble works of different eras and styles. Playing in a quartet plays

no less a role than a chamber ensemble in the professional training of string students. The tasks that are solved in quartet music, compared to the chamber ensemble, are more difficult, because in the absence of a piano, the main load is performed by the first violin. However, a full-fledged quartet is often impossible in practice, and the alternative in this case is playing in a string ensemble.

Playing in violinists, cellists or mixed ensembles is a common form of music making in any music school. In addition, such ensembles are a common form of collective music in extracurricular cultural and artistic institutions (Houses of Culture, Palaces for Children and Youth, Art Centers, etc.). The established traditions of instrumental performance in ensembles of these so-called "free" forms best contribute to the diverse professional development of future musicians.

Working with an ensemble of stringed bow instruments on the piano, in addition to the general provisions mentioned in the previous section (classes organization, training level of participants, their psychological compatibility, etc.), requires consideration of special properties due to certain features of the instruments and their possession. Thus, accurate reading of the text, which is the main criterion for the disclosure of the author's intention, in ensemble music requires consolidation of participants' efforts to solve dramatic issues, work out interpretive decisions and related choice of expressive means, performance, techniques, etc. In addition to working on the content, character or style of the work, it depends on the skillful distribution of functions in the ensemble between the participants, which is realized by establishing a dynamic plan and sound balance of all instruments, the same type of fingering, strokes and sound production of string instruments and piano, etc.

Achieving sound balance is realized primarily by controlling the volume and balance of the piano with strings. The problem is complicated by the fact that the sound of the piano is much stronger than that of stringed instruments (especially when performing the strokes of a hundred, spiccato, playing in low registers, etc.). So, to establish the necessary balance of sound, pianists must be very sensitive to the register in which a certain phrase or stroke is performed on a string instrument, take into account the specifics of the game associated with the transitions of the bow from string to string and change positions in the left hand to the specific performance of chords that string players usually «break», etc. The specifics of the piano sound in the ensemble were generally paid attention by researchers [11, c. 4-5], but the peculiarities of the ensemble performance of the piano with string instruments were not considered separately.

The high-quality sound of the ensemble, the perfect technical performance of the ensemble work, are also associated with a number of specific tasks. One of the cornerstones in this direction is the work on intonation, the result of which should be absolutely accurate intonation of strings with a tempered piano structure. The main condition of this work is a careful practice of intonation accuracy and listening to string performers to the complete fusion of the sound of all instruments. Often the work on intonation is complicated by strokes or effects, the implementation of which requires perfect coordination and technical equipment (glissando, vibrato, dotted rhythm and «jumping» strokes, etc.). In the ensemble, such playing techniques should be performed much clearer, more restrained than solo, and the filling of the sound in the strings - to correspond its extinction in the piano.

The specificity of the ensemble of strings with piano also affects the peculiarities of work on the form. Along with the general tasks of building a dramatic line, defining the character and color of themes, reproducing tonal, dynamic and textural changes, work on the structure of the work requires considerable attention. This is especially true of the form of rondo or variations, where it is necessary to build a general plan of execution, to determine the nature of the episodes, game techniques. A certain difficulty in reproducing such form is the change of sections, when you need s

quick switch from one mood and type of sound production to another, which requires participants to concentrate significantly during the performance. Structural dismemberment provokes another common drawback, when there are unnecessary pauses between sections, which often occurs due to the inability of performers to immediately move to the desired tempo or nature of the new partition. Unpredictable stops violate the integrity of perception, deprive the work of artistic significance, and therefore requires an intense practice in the ensemble.

Ensemble work on a technical or slow composition has its own specifics. When studying a fast technical work for a string ensemble with a piano, it is not recommended to give too virtuoso compositions, as the lack of professional and ensemble skills significantly complicates the work and can negatively affect performance. It is better to take feasible moving pieces for which students have sufficient technical skills. The method of studying them in the ensemble is similar to working on a solo virtuoso work, but requires careful coordination of the participants. An indispensable principle is that you should start learning the work at a slow or medium tempo, and as you approach the performance you can play at the tempo specified by the author, but constantly return to a moderate tempo to avoid «forgetting».

Learning a slow work is often no less difficult than learning a technical play. In slow compositions, due to the inability of the ensemble members to feel the required tempo and transmit movement, the content and form are often distorted. Common mistakes are to perform at too slow or too fast tempos, which disrupts the movement of musical thought, or vice versa, leads to fuss and reduces the figurative and emotional depth of the composition. To correct the situation helps to learn the necessary movement through memorizing the temporitum, understanding the content of music, establishing associations with familiar images with the works of slow-moving students [11].

Nuance acquires great importance in the development of the form. Flexible dynamics, clear and logical dynamic plan of the work becomes the basis for the successful embodiment of the artistic image. The dynamics in the ensemble must be reproduced especially clearly and convincingly, because the depiction of a certain sound image depends on the method of sound production, which is determined by one or another nuance. The role of each instrument of the ensemble in the creation of an artistic image is determined by a certain sound delivery, but the piano acquires a leading role due to the leading qualities of the instrument. Thus, in the reproduction of artistic imagery and form in terms of dynamic development, the "cementing" function in the ensemble belongs to the pianist. All these factors of ensemble specificity are determined by the requirements of synchronous playing. In addition to adhering to a single temporitum, dynamic plan, the same type of strokes, fingering, sound production, etc., synchronization of ensemble performance is associated with the moments of simultaneous entry of all participants (work on auftakt) and completion of the work, execution of fermats, agogic deviations, etc. Their reproduction in the ensemble largely depends on the constant visual control, but in the process of work all these elements must be accurately established and calculated by all participants.

The end result of the ensemble work is a concert performance. Its success largely depends on rehearsals in the hall where the event will take place, determining the place and playing angle («sound points»), calculating the sound balance of the piano with other instruments. The success of a concert performance with proper training of participants is facilitated by their well-being and mood, appearance, etc. However, the most important role in this is played by the feeling of each participant as a member of the team, which helps to overcome the excitement, adds confidence, game «tone» to the performance and experience of stage performances.

Features of work with piano ensemble

Since the last third of the XVIII century, time of continuous spread of the piano, a favorite form of playing this instrument is playing in an ensemble. Originally spread in amateur circles, at the beginning of the XIX century the piano ensemble, especially the piano duet, was established as the most popular type of musical culture, which has not lost its popularity even nowadays. Today, various duets of famous pianists are formed around the world. Among the Ukrainian performers of piano duets, we can mention I. Aleksiiichuk and Y. Kot, O. Zaitseva and D. Tavanets, O. Kopeliuk and I. Serdiuk, the duo «Oleyuria» (Olha and Yurii Shcherbakov), etc. Among the foreign groups are the ensemble «Piano4te aus Ubstadt-Weiher» (12 pianists for one piano) under the direction of Professor Christophe Sishka (Germany), piano duets of Sivan Silver and Gil Harburg (Israel), Olena Vardanian and Iryna Savina (Moldova), McCoy Tyner and John Coltrane (USA), the duet «Duo Turgeon» consisting of Anna and Edward Turgeon (USA), etc. The active splash and popularity of music in piano ensembles in recent decades have contributed to the emergence of many different competitions and festivals of this type of ensemble activity, which indicates its relevance and demand.

Despite the general interest in this type of piano performance, it should be noted that the piano ensemble as a discipline in general does not appear in the curricula of art institutions of any level. This form of music is most widely used in music schools within the general subject of «ensemble», although in most educational and cultural arts institutions piano ensemble can be the form that helps to attract the widest possible range of pianists, increase mastery of the instrument and reveal their professional performance.

The piano ensemble differs from other types of instrumental ensembles in its specificity. Depending on the type of the ensemble (four or six hands, for two, three or more pianos) the features connected with application of a certain type of sound production and musical means of expression are defined, various performance problems concerning artistic interpretation, sounding integrity of parts and synchronization of actions of all participants arise, etc. But even the optimal piano duet has important genre and performance differences, which depend on the purpose of the work to be performed on one or two instruments, the orientation of the concert performance in the chamber hall or on the big concert stage. Well-known domestic musicologist I. Polska notes the following features of the piano duet: different sound volume of the performance space; different: spatial and acoustic orientation; structuring the executive space; communicative and psychological specifics [10]. Given the above, it is possible to establish the main difficulties and areas of work in the piano ensemble.

The most popular type of piano ensemble is a duet for four hands on one instrument or a duet for two pianos. The prevalence and propensity of pianists to duet performance is due primarily to its availability (in art institutions, the usual presence of two instruments in the audience), and the convenience of working at all levels of mastering the skills of ensemble playing. The priority in the work of a piano ensemble of any composition is the musical work understanding, its genre features, structure and form, which directly affects the quality of interaction of participants. The figurative content of music and its emotional impact are directly related to the feeling and reproduction of the style of different eras and trends. Therefore, it is appropriate to start lessons in a piano ensemble with a comprehensive acquaintance of students with the performed work. It will not be superfluous to touch the era of creation and style, which influences the choice of expressive means and strokes.

The next thing needs to pay attention in the work of the ensemble is the synchronization of the performers' play and their interaction with each other. At this stage the characteristic difficulties

inherent only in the genre of piano ensemble are revealed, which consist primarily in the fact that the «psychological specificity of duet communication is based on the interaction of centripetal (performer-performer) and centrifugal (performers-listeners) tendencies. Four-handed piano duets are more characterized by the first of them, associated with the psychological orientation of the performers to each other - at the same time in two-piano duets prevails a common communicative instruction “to the public”» [10, p. 173]. The following main types of interaction of pianists are formed: 1) ensemble of integrating type (effect of «one performer»); 2) an ensemble of dialogic type (equality of partners) [10, p. 174]. Thus, the limited use of one instrument creates the conditions for special communication and mutual understanding between the members of the four-handed duet.

Historically, this type of ensemble functioned mainly in home music-making, which determined its specificity, characteristic feature of which is the commonality of empathy and internal intimacy. After all, the division of the «territory» of the piano between the two participants requires from them not only the conditional delimitation of the claviature and understanding of the meaning of each part, but also psychological and executive unity, without interfering and supporting each other during the game. In the long practice of four-handed music, the techniques of crossing hands, smooth transfer of material from one member of the ensemble to another, simultaneous entry and end of music composition, etc. were approved, which became the basic principles of ensemble pianists.

Compared to a four-handed ensemble, an ensemble for two or three (or more) pianos differs not only in certain genre features, primarily related to the specifics of playing individual instruments, but also in the performance representation of each participant. Piano duets or trios were quite popular in the late XVIII and along the XIX centuries, as the piano was used as an instrument that could replace the sound of an orchestra. This gave performers the opportunity to get acquainted, study and perform various complexity of opera, symphony or concert compositions, and interest of composers in the genre of piano ensemble.

This functional purpose of the instrument has led to greater dialogicity and separation between ensemble parts than in a four-handed duet. In addition, the greater psychophysical freedom of performers who perform on two or more instruments, allows to turn to more complex in a virtuoso musical works. However, in such conditions, it is more difficult for performers who are at a certain distance from each other to achieve unity of action. Performing on several pianos requires closer coordination of the participants' movements, which must take into account the different timbres of the instruments and the originality of the performance manners, which are much more pronounced in terms of relative freedom than in playing one piano.

The work on the study of compositions for piano ensembles includes familiarity with both general aspects of musical art (knowledge about the genres and styles of works for claviers or piano, their belonging to a certain era and characteristic artistic and technical features, etc.) and specific elements related to piano performances technique (various types of equipment and sound production, agogic and stroke techniques, etc.). Thus, when working on piano ensembles (duets, trios, quartets, etc.) it is important to adhere to the tempo synchronicity, line expediency, the establishment of a unified dynamics and line of dramatic development.

Flexible dynamics, as one of the main elements of the artistic imagery formation, is an effective means of enhancing the expressiveness of performance. A clear and logical dynamic plan of the whole composition becomes the key to the disclosure of the musical image. Ensemblers must

accurately and clearly present the overall dynamic plan of the work to avoid the problem of determining the lead ensemble, which arises if the sound balance between the participants is the same or prevails during the work of one of the pianists. Establishing and simultaneously performing the culmination of the work, the gradual increase or decrease of sound or sudden contrasting changes in volume significantly affect not only the phrasing, but also the composition of the work as a whole. At the same time, the work on dynamics in an ensemble on one instrument or on several has the specificity. Thus, when playing in an ensemble on several instruments, the spatial-acoustic range expands, which can affect the insufficient feeling of each participant, both the partner and his own party. For better coordination of the performance of both parts in such an ensemble, it is advisable to contact the "third party" of the teacher or student.

Mastering the technique of ensemble performance is based on specific components of common play. Careful work on the strokes requires great attention, the artistic expediency and persuasiveness of which in each part is determined by the requirements of the overall sound of the ensemble. Articulation is extremely important in the complex of expression means. The use of inappropriate dashed or artistically expressive elements can prevent the correct interpretation of the artistic image, which is due to both genre and stylistic features of works of a certain era, and the historically established «set» of elements of musical expression.

One of the main factors and criteria of ensemble performance is a sense of tempo and rhythm. Working to achieve a single tempus is the cornerstone of any compatible music making. A typical error that causes rhythmic instability is an unmotivated change of tempo, which occurs during *accelerando* or *ritardando*, when changing the rhythmic pattern (especially when using polyrhythm), texture, key, etc. Correction of this shortcoming is carried out by controlling the tempo, equalizing the metric pulse and working out complex episodes of the work at a slower tempo.

Work in the ensemble class should be aimed at the formation of professional skills of ensemble feeling, as well as the activation of important personal qualities of the performer. The main principle in solving the problem of forming a culture of performing skills in a piano ensemble is, of course, the process of collective playing. Common performance of musical compositions requires from partners a developed sense of performance intentions, forms the ability to clear analyze their actions and timely adjustment of individual techniques in favor of the unity and integrity of the ensemble sound.

Common performance in any composition of a piano ensemble involves the practical application of ensemble music skills and modeling the situation of future professional activity. Depending on how much each of the performers understands and feels each other depends not only on the quality of work in the class, but also the level of further concert performance.

Conclusions

Thus, participation in the ensemble and compatible music provide students with ample opportunities for the development of professional and communicative skills, develop the ability to collectively address issues (interpretations, search for expressive means and performing techniques), contribute to the acquisition of artistry and stage freedom, etc. The complex components of forming the culture of ensemble performance of future specialists of music art includes professional factors of different directions. First of all, it is a diverse ensemble repertoire, which opens up wide opportunities to become acquainted with music of all eras and styles, promotes the development of artistic taste, teaches to open and interpret the content of the work.

During the ensemble sessions, the necessary professional and specific skills are developed - understanding the content and artistic imagery of the work, technical ownership of the instrument, the ability to hear and feel partners, establish a sound balance, invent timbre coloration. The concert performances of ensemble give the participants more practical experience of playing in public, the ability to behave on stage. Among the main components that most significantly influence the quality of the development students' ensemble music culture are the following: the level of performing and technical skills of the ensemble members; clear organization of the educational process; effective cooperation of the student with the teacher; understanding of ensemble music of different styles and features of its performance and interpretation; technical level and artistry of performance. Work with certain executive structures composition – string instruments with piano or piano ensembles – requires the use of appropriate special methods and techniques, given their specifics.

Constantly growing in performing and listening interest in ensemble performance, professional efficiency and considerable practical experience of classes by ensemble at students determine the need and feasibility of introducing various forms of ensemble music in the educational process. Of course, in the different levels of art education institutions high-quality education of ensemble groups possibly in the presence of an appropriate level of scientific and methodological justification.

Due to the almost no development of scientific and educational literature on these issues, the problems proposed in the article have wide prospects for further development.

References

1. Beljanin V.S. (2008). The specifics and psychological aspects of ensemble performance. *Voprosy muzykal'noj pedagogiki*. Tolyatti: TIA [in Russian].
2. Boronina T.I. (2007). The role of the chamber ensemble in the education of musicians. *Vestnik Tomskogo gosudarstvennogo universiteta*, 5 (49), 72-77 [in Russian].
3. Chvanova A.N. (2005). *The formation of artistry among musicians*. Extended abstract of candidate's thesis. Samara: SSU [in Russian].
4. Han Yucen (2019). *Formation of skills of artistic-creative self of future musical art teacher in the process of professional training*. Extended abstract of candidate's thesis. Sumy: SSPU [in Ukrainian].
5. Haritonov B. (1995). Problems of chamber ensemble performance. Donetsk [in Russian].
6. Ivanova N.A., Firsova A.V. (2016). Organization of a chamber ensemble. *Pedagogicheskoe masterstvo*, (Part 1), 46-48 [in Russian].
7. Maksimov V. (2018). To the problem of stage unrest. *Muzykal'nyj al'manah Tomskogo gosudarstvennogo universiteta*, 5, 77-80 [in Russian].
8. Pan Xingyu (2019). *Methodology of preparing bachelors of musical art for the formation of students' audio culture by means of orchestral music*. Extended abstract of candidate's thesis. Sumy: SSPU [in Ukrainian].
9. Polianska K.V. (2016). Special features form ensemble gree in school-music lessons at children's music schools and children's schools of mysteries. *Aktualni pytannia mystetskoj osvity ta vykhovannia*, 2 (8), 214-223 [in Ukrainian].
10. Polska I.H. (2018). Piano duet in the system of piano ensemble: genre-typological aspects. *Kultura Ukrainy*. 61, 167-178 [in Ukrainian].
11. Solopakho G. P. (1987). *On improving the teaching of the chamber ensemble in music schools: Methodological recommendations*. Minsk [in Russian].

Olha Kuchma

Doctor of Law, Assistant Professor

*Professor of Taras Shevchenko National University of Kyiv,
Kyiv, Ukraine,*

orcid.org/0000-0002-2206-3286

Liudmyla Sinyova

Candidate of Laws,

*Assistant of Taras Shevchenko National University of Kyiv,
Kyiv, Ukraine,*

orcid.org/0000-0002-5514-3549

Galyna Kuzmenko

Candidate of Laws,

*Assistant of Taras Shevchenko National University of Kyiv,
Kyiv, Ukraine,*

orcid.org/0000-0002-4054-3910

**OCCUPATIONAL SAFETY AND HEALTH AND PREVENTIVE MEASURES IN COAL
INDUSTRY**

Abstract. *The article deals with the problem of safety of workers, including employees of coal industry; the need to improve the existing legislation in the mentioned field and to give more attention to preventive measures within occupational safety and health is determined. The difference between labour and civil relations (working hours, overtime, off - hours, working place and so on), which influence the fact of recognition a person as a victim of industrial accident, is highlighted. The mechanism of compensation for employers, who declined the number of working places with harmful conditions, is recommended; the provision stating, if during 5 years new working places with harmful conditions will appear, then pegged compensation has to be returned in proportion to the quantity of created working places with harmful working conditions in order to prevent abuse also is foreseen; the factors, influencing the condition of occupational safety and health, are detected. The changes to current legislation concerning the involvement of the territorial authority of the State Labour Service of Ukraine to special commission for investigating and accounting the industrial accidents, occupational diseases and industrial crashes are offered. It is determined, that they will improve the legal quality of law of regulation and contribute to legal certainty in regulation of relations, concerning the procedure for investigating and accounting the industrial accidents, namely concerning the victim, who is a worker and a person, providing services under a civil contract simultaneously.*

Introduction.

Safety is the main need of every person and a major factor in the life of society. The proper safety in the state production sphere should be maintained by observance of relevant normative legal acts, responsibility of officials in organization and management of production, compliance of specific executors of labour process to the work performed. Unfortunately, the number of emergencies in Ukraine is not diminishing, and the budgetary costs, aimed to overcome the results of accidents, are constantly increasing. And while the death toll and casualty rate remain almost unchanged, these values substantially exceed the according rates in developed countries. This proves, that Ukraine technogenic and industrial status requires the transition to security regulation, based on the modern paradigm of risk-oriented approach, generally accepted by the most countries of the world [1].

It is well known that poor occupational safety and health results in slowdown of both economic growth and social progress. Industrial security is one among fundamental factors for sustainability and stability of economy, capacity for self-development and progress in every country [2].

According to the information posted on the State Labour Service of Ukraine website as of January 1, 2018, there were 69 mines in Ukraine in different condition. This information is reproduced in Fig. 1 [3].

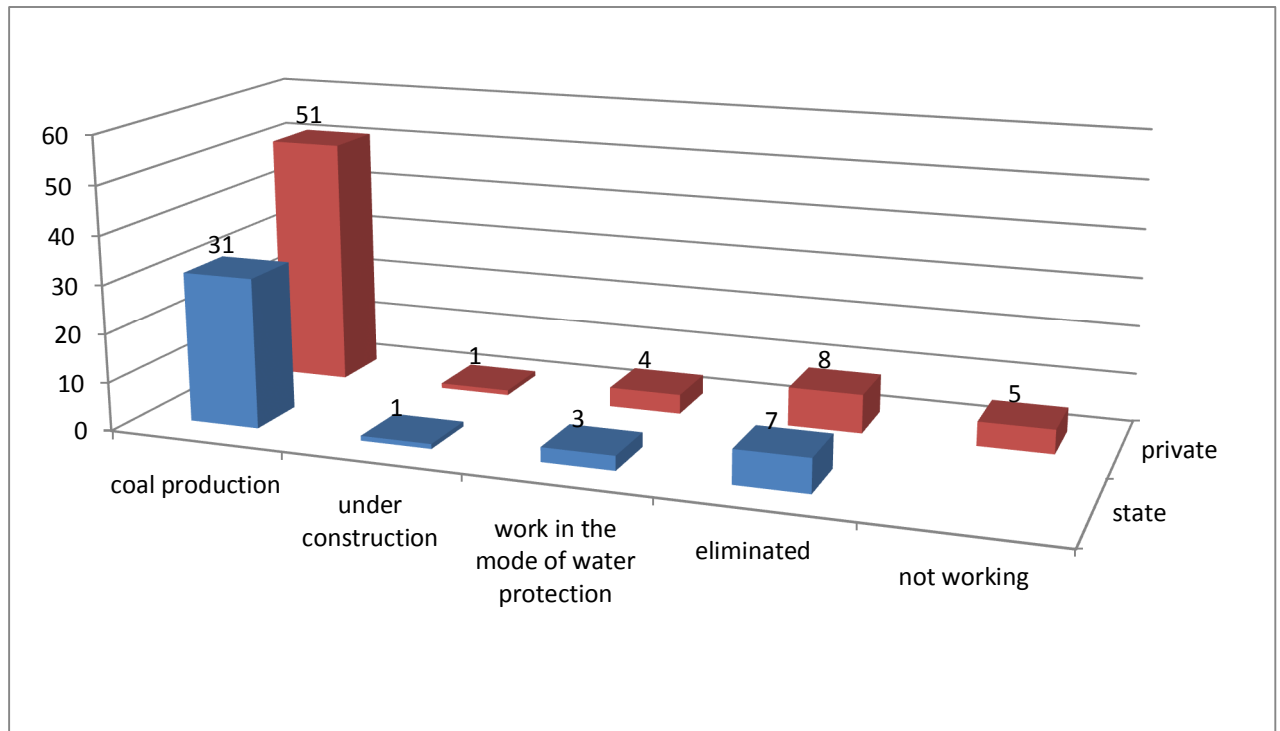

Fig. 1. Information on the State Labour Service of Ukraine

According to experts of the International Labour Organization (ILO), there are 2.2 million work-related accidents each year in the world's 2.8 billion working-age population. On average, 5,000 people die from occupational injuries every day. The total number of workplace accidents is around 270 million. The number of diseases caused by unfavourable working conditions reaches 160 million cases. Occupational accident losses account for 4% of world gross domestic product (GDP). The majority of occupational accidents and diseases in developing countries occurs in industries such as agriculture, fisheries, logging and forestry, mining and construction [2].

Unfortunately, there are a lot of examples of research relevance in the field of occupational safety, as evidenced by the numerous death accidents. This confirms the existence of the safety problem in the coal industry.

The General Report of the Coal Industry Supervision Division on the State of Occupational Safety at Coal Enterprises for 2017, which is available on the State Labour Service of Ukraine website, identifies major traumatic factors that have led to the fatal accident in underground conditions.

This information is reproduced in Fig. 2 [3].

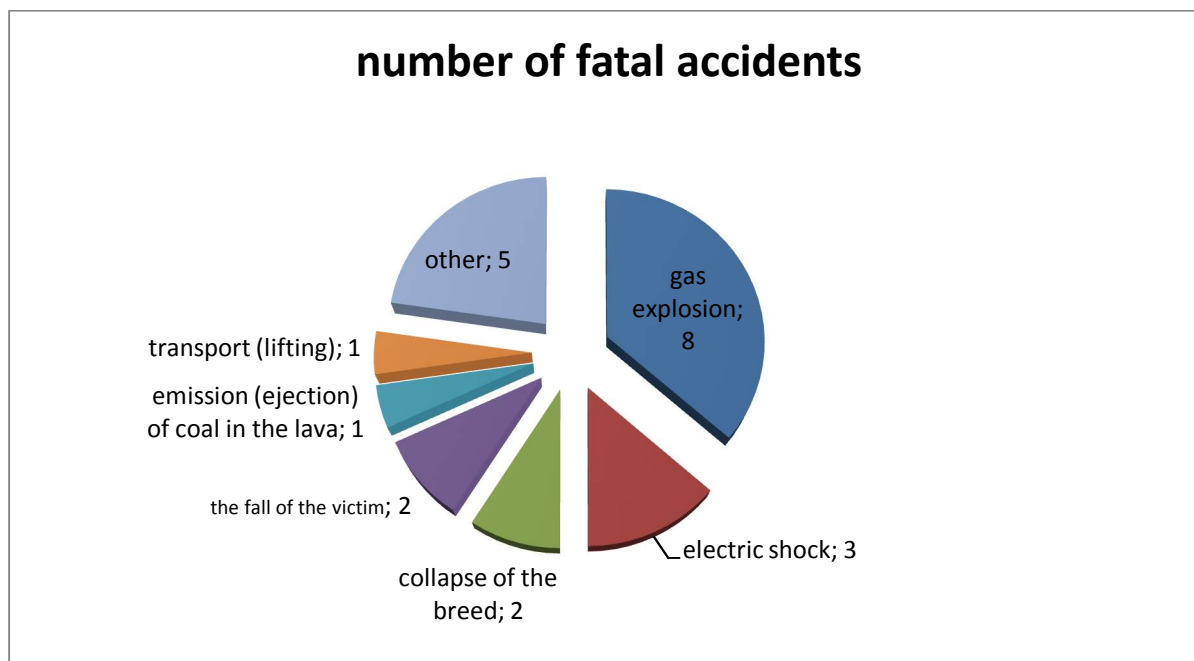

Fig. 2. Number of fatal accidents

Working in the coal industry has additional risks which are important to consider about while ensuring safety at work. Proper legislative regulation of investigation of industrial accidents and occupational diseases is also equally important.

1. Gaps in legislative regulation of the investigation of accidents and occupational diseases.

Ukrainian mining law has deep historical roots, linked both to the age-old traditions of Ukrainian mining and to the collisions of modern government in Ukraine. It entered a new phase of its development in the early 90's of the twentieth century. The process of developing and adopting of the new laws and other regulations connected with modern mining relations is intensively underway. It is being implemented while controversial period of transition from the administrative system of management of the mining industry to the market economy of the rule of law. All these processes are reflected in the current legislative acts, which, on the one hand, are characterized by the progressiveness of new legal norms and institutions (mining concession, product distribution, etc.) and, on the other, by the recurrence of the principles of so-called democratic centralism. This is a testament to the complexity of socio-economic, political and legal conditions in which Ukraine's modern mining law is developing [4].

The current Occupational Accident Investigation Procedure doesn't contain properly resolved procedural issues while investigating accidents, involving persons working under civil contracts. Despite the unfortunate statistics of accidents in the coal industry, we believe that attention to additional resources that need to be stepped up to improve occupational safety at work (support for domestic innovative technologies, analysis of economic feasibility in creating safe working conditions or closing unsafe areas in production, encouraging employers to improve working conditions) is not properly paid.

The article analyses changes of the legislation regarding a new category of persons who are subject to compulsory state social insurance against accidents and occupational diseases. These are persons who perform work and provide services under civil contracts (The Law of Ukraine "On Compulsory State Social Insurance" as well as the new Procedure for Investigation of Accidents

(Resolution of the Cabinet of Ministers of Ukraine “On Approval of the Procedure for Investigation and Accounting of Accidents, Occupational Diseases and Occupational Accidents.) Also, while issues of preventive measures are being considered, the positions of scientists concerning work in harmful and difficult working conditions (T.O. Didkovskaya "The Essence And Importance of Work with Harmful and Difficult Working Conditions", "Classification of Work with Harmful and Difficult Conditions Work), the ILO's position on factors of the production environment (B.I. Stashkiv " Social Security Law") have been analysed, as well as the monograph by O.L. Kuchma "The Problems of the Theory and Regulatory Regulation of Social Insurance in Ukraine", which highlights the incentives and penalties that encourage employers to reduce hazards in the workplace. The works of other scientists, regulatory acts, statistical information, mentioned in the paper, have been also analysed within the framework of the investigated issues.

Since 01.01.2018 the legislator has expanded the range of subjects who are insured against industrial accidents and occupational diseases (hereinafter - accident insurance) by including insured persons and persons who provide services or perform work under civil contracts [5].

The amendments to legislation have expanded the social maintenance of insured persons, since employers do not always formulate employment relationships by conducting an employment contract. And although sanctions are provided for every unformed employee, employers either form none relationship with an employee or enter into civil contracts for work or service.

However, civil contracts are not always concluded in the presence of employment relations; there are also situations where, depending on the conditions of cooperation, the parties choose the civil legal framework for cooperation. Sometimes, it is more important for a person to perform work or provide services at his own risk than to have increased social protection but to observe labour discipline.

It is advantageous for employers to arrange relationship with an employee in the form of a civil contract (despite the employer's risk of verifying the fact of employment relations and applying sanctions by controlling authority), since it is possible to terminate the contractual relations in a manner specified in contract (without using the grounds stipulated by labour law) and to avoid annual paid leaves, pay guarantees for employees, etc.

Also, employers have no obligation to provide safety training to persons working under civil contracts, that's why classifying them as persons, who are insured against industrial accidents, especially those who are forced to work in harmful and dangerous working condition, should become the next important step towards their social protection.

In order to implement these changes and taking into account the need for better regulation of legal relations in the field of labour protection in Ukraine, the Resolution №337 “On Adoption of Procedure for Investigating and Accounting of Industrial Accidents, Occupational Diseases and Industrial Crashes” has been adopted [6] (hereinafter - the Procedure).

However, the fundamental differences between labour and civil relations haven't been taken into account (contractors and service providers do not concern about the work schedule of the enterprise, there are no beginning and ending of work, overtime, days off, holidays, leaves and other factors, affecting qualification production-related accidents), but this category has been only mentioned in the Procedure as another category of persons, also covered by the Procedure. The importance of improving the legislative framework has been also emphasized in the Conception of Reforming of the Coal Industry in Ukraine [7].

Taking into account the possible legal constructions, there are 8 combinations of legal bases of relations between an insured person and an insurer, depending on the legal relations of parties (Fig. 3).

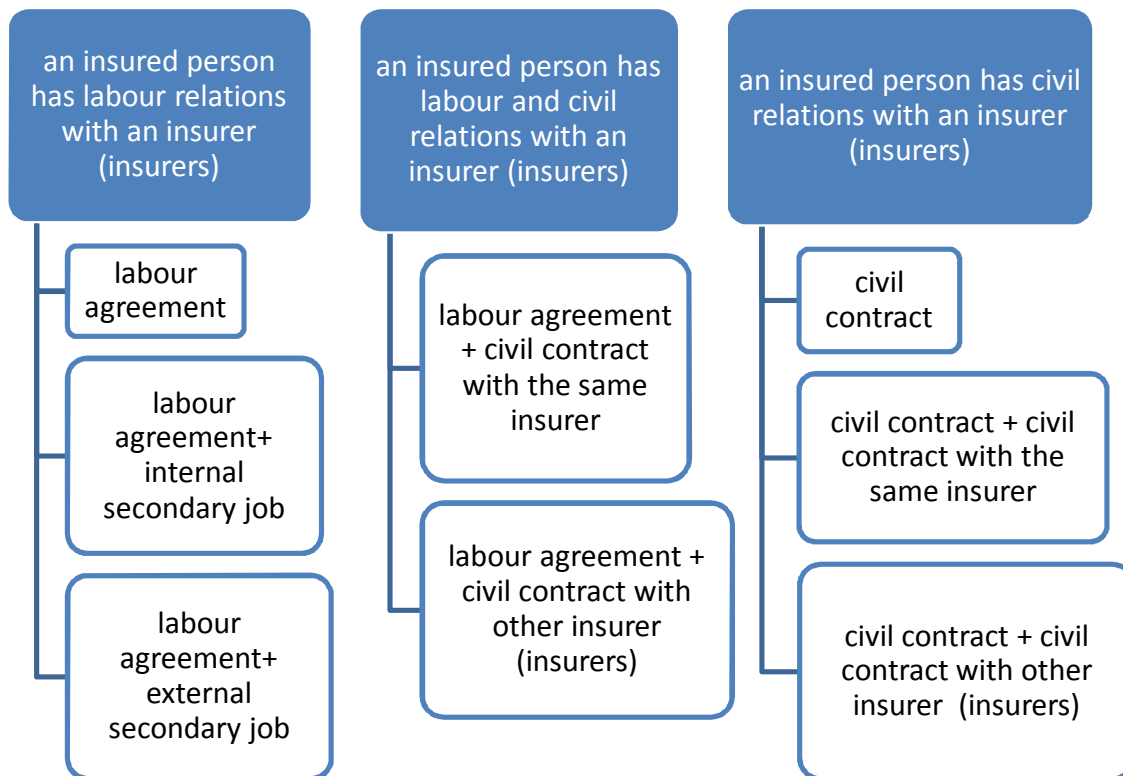

Fig. 3. Legal grounds for relations between an insured person and an insurer.

The Procedure establishes that accidents with persons working under the terms of a civil contract are subject to special investigation. A representative of the local state administration or local self-government body is included to that special commission. Also, item 15 of the Procedure stipulates that, if necessary, officials of the State Labour Service and / or its territorial body by branch can be included to commission. Taking into account the additional risks of labour in the coal industry, which are peculiar to both workers and persons working under a civil contract, it is necessary to complement the Procedure with mandatory rule for involving a territorial body of the State Labour Service by sectoral direction to a special commission and commission for investigation of accidents.

2. Preventive measures in the field of labour protection.

The market economy, including the coal industry, cannot work effectively without human resources. The safety of production processes is beneficial to both employees and employers. However, not all employers understand this and save on preventative measures.

According to the statistical information, the most disadvantaged sectors are coal industry, socio-cultural sphere and trade, agro-industrial complex, mechanical engineering, construction, metallurgy.

It is a well-known fact, that accident is a negative socio-economic phenomenon. The largest financial costs are borne by the company due to accidents and industrial crashes. Back in 1920, the “Iceberg Theory” was developed, which stated that the financial costs of the company are divided into direct and indirect. Direct financial costs for an accident include: payment of wages and

surcharges for the period of absence of the victim at work; cost of medical care, medicines; cost of training and retraining of workers instead of lost, due to loss of life or disability, etc. Indirect means the loss of working hours of other persons (except the victim); damage to property and products of the organization; lost prestige of the company; remuneration of lawyers; fines and other damages [8].

However, in addition to financial costs, the social consequences of accidents and catastrophes are much more significant - the loss of health, the lives of citizens and the labour potential of the country, the increase in the number of single-parent families and orphans. Attention should be also paid to the socio-psychological tensions of the population caused by accidents and their consequences, as well as to the deterioration of the international image of the state in general. The employee prefers to work with lower risks to life and health. The total amount of annual economic loss in national economy due to staff turnover and dissatisfaction with working conditions exceeds 0.6 billion UAH. [9].

Managing the economic activity of the coal industry requires modern information support. Labour costs are its important part and one of the most important element of the labour process. Such information can be interesting first of all to real and potential users of information resources. The formation of labour costs and its safety, are preceded by complex accounting work, which depends on the reliability and objectivity of the information needed for managerial decision-making by executives [10].

In the context of the critical situation concerning occupational safety in coal industry and increasing requirements for labour security, it is important to receive detailed information about labour safety, its costs and effectiveness along with the assessment of production processes. Depending on these tasks, labour protection accounting can be divided into accounting, aimed to obtaining data for the preparation of financial statements - financial accounting and accounting, aimed to obtaining managerial decisions regarding the formation of the mine's social strategy, evaluation of cost effectiveness in terms of labour protection measures; setting the price of coal, taking into account the real costs of its production; cost control - management accounting. Management accounting of labour protection activities is intended to solve the following tasks:

- determination of planned costs for implementation of labour protection measures and sources of their financing;
- formation of cost estimates for labour security activities and control over its implementation;
- compilation of internal reports by segment of labour protection activities for management needs.

Unlike financial accounting, which is intended to form information in terms of its usefulness and decision-making, management accounting involves the cost-oriented position for formation of costs in the context of processes of coal mining technology and management services. An important task of management accounting is predicting the results of future operations [10].

It is better to pay for preventative measures than to pay for the costs of injury and to offset the costs of burial.

The coal industry is a very specific industry that has a number of features. One of which is the inability to change the conditions of production, labour, as well as the natural mountain-geological conditions. Mining and geological conditions of the coal industry of Ukraine are one of the most difficult in the world coal mining. In Europe, mines with conditions same to Ukrainian

now were closed long time ago. That is why the coal industry of Ukraine is characterized by difficult and very dangerous working conditions, which is unfortunately confirmed by a large number of serious and fatal accidents [10].

The work conditions of miners are significantly different from the production conditions of other industries. These are aggressiveness of the environment, high temperature and humidity, potential risk of explosion of methane and coal dust. Therefore, mine safety issues are of great importance. It is especially dangerous in places where deep horizons are being developed, the air temperature rises and conditions for the sudden release of methane and coal dust appear [11]. Along with complex mining and geological conditions, the crisis situation of the coal industry in Ukraine in terms of technical, economic, financial and social indicators has a significant impact on the level of accident, traumatism and occupational diseases [10].

The requirements for organization and safety of workplaces are enshrined in the General Requirements for employers to provide employees with occupational safety and health. This document establishes requirements for creation of safe and harmless working conditions through the proper arrangement of workplaces, industrial, sanitary and other premises at the enterprise, institution, organization, provision of training of workers and involvement of them in solution of labour safety issues, regulation of labour safety between enterprises in case of involvement in performance of work employees from other enterprises [12].

The organization of occupational safety at coal enterprises covers a wide range of issues. However, not all of them are qualitatively solved. More than a half of mines operate without reconstruction, they have sophisticated ventilation nets and tiered transport. In the current fleet of slaughtering equipment, the proportion of treatment machinery complexes and combines of new technical level is only reaches 2%. On the whole, industrial-production funds of coal-mining enterprises are worn out on average by 65% [10].

B.I. Stashkiv highlights that the ILO points to the following factors of working environment that affect person and cause him fatigue: 1) physical effort (moving or maintaining loads, efforts to press for labour, etc.); 2) nervous tension; 3) the pace of work; 4) working position (the position of the human body in relation to means of production); 5) monotony of work; 6) temperature, humidity, thermal radiation in the work area; 7) air pollution; 8) production noise; 9) vibration, rotation, shocks in the workplace; 10) lighting in the work area. Social legislation gives legal importance to working conditions that adversely affects human health and well-being [13].

Labour law obliges an employer to create safe working conditions for workers, however, as T. Didkovskaya rightly observes, the conditions can be favourable and unfavourable, may depend and not depend on person. Yes, geographic, biological, geological and other similar factors do not depend on humans. That is, they are conditioned by an appropriate activity and cannot be excluded by human effort, but can only be modified and adapted to individual in some way to reduce their negative impact on the employee [14].

According to the State Sanitary Rules and Regulations, harmful working conditions are such working conditions in which the level of influence of one or more factors of the production environment and / or the work process exceeds the allowable one.

The legislator defines the right for retirement pension on preferential terms, operating the category of "hazardous working conditions".

In scientific works, hazardous working conditions are defined as conditions when at least one indicator of the difficulty of the labour process exceeds the established norms [14].

According to T.O. Didkovskaya, dealing with harmful and hazardous working conditions is the pursuit of work activity in conditions where one of the factors of the production environment or one of the factors, characterizing the difficulty of the work process, exceeds the norms established in the appropriate order and procedure, and in this connection there is a negative impact on the health of the employee [14].

Taking into account the occupations and positions in both 3th and 4th classes of working conditions, the legislator provided an increased level of social protection for such workers, establishing the right for retirement age on preferential terms among other things.

Since employers treat differently the obligation to ensure safe and harmless working conditions, it is premature to exclude works, containing increased risk of harmful factors in the workplace from the list of harmful professions and positions. It is advisable to provide the mechanism of compensation for employers who have reduced the number of jobs in production with harmful factors (also to set provision, providing, for example, if within 5 years there are new jobs in this production with harmful working conditions, then the indexed compensation will be returned in proportion to the number of new jobs created with harmful working conditions).

The state needs to save money not only by reducing the list of professions with the right to retire from an earlier age (there is a need to revise these lists of professions, taking into account the development of science and technology), but also by stimulating employers to improve working conditions by investing in modernization of equipment and elimination (in cases of failure elimination - maximum reduction) of harmful factors in the workplace.

Reducing the number of jobs with harmful working conditions is not only the removal of preferential calculations of length of service in a certain position, but also the creation of conditions safe for life and health of an employee. This is advantageous for the Social Insurance Fund of Ukraine (reduced risk of industrial accident and occupational disease, respectively, and the possibility of avoiding additional costs in the future) and for the employee (insurance payments in case of an accident - an industrial accident or occupational disease, an earlier retirement pension is a financial compensation that will help to cover health care costs [15]).

The Law of Ukraine "On Compulsory State Social Insurance" defines carrying out measures for the prevention of insured events and also establishes the use of the Fund's budget to finance measures for the prevention of insured events on of the tasks of the Social Insurance Fund.

The list of issues considered by insurance experts during inspections of business entities includes: the implementation of preventive measures on labour safety and other labour safety measures on the basis of plans of work, orders, collective agreement, contract [16]. The problem is that preventative labour protection measures at enterprises sometimes take place formally, for audit, and this reduces the effectiveness of planned interventions. It would be appropriate to take advantage from the foreign experience concerning preventive measures in the field of labour safety.

As it is emphasized by V.R. Serdyuk and L.V. Mymryc, the review of accordance and adaptation of labour and industrial safety legislation to EU legislation is one way to reduce occupational injury and morbidity. Addressing the problems of improving occupational safety requires a comprehensive approach that involves development and implementation of a range of measures at the state, employer and employee levels. The most effective factor in this case is government.

It should facilitate the development and implementation of social standards; define the economic management mechanism in the field of labour safety; increase the level of scientific and technical support; implement scientific achievements in practice; develop new methods, systems, diagnostic tools and assessment of its condition. Taking into account the reasons of accidents, it is necessary, first of all, to improve enterprise safety at the level management system and to develop a number of measures to improve its training. The complex implementation of mentioned above measures is entirely about defining the concept of "occupational safety" as a system of legal, socio-economic, organizational, technical, sanitary and preventive measures and means aimed to preserving life, health and efficiency of the person in the labour process activities [2].

For more effective labour safety it is necessary to strengthen the control over the quality of the used equipment (its guarantee, repair works, the possibility of modernization), pay attention to alternative ways of performing the labour function, compare economic interest and investing in improving or closing the work area, profitability of mines. It is also necessary to calculate costs aimed to employment of persons who will lose their jobs (in the case of absence of work - costs of unemployment benefits, retraining) during closing any work section.

Conclusions

Occupational safety in general and labour security in coal industry in particular are not in the best condition, and this is influenced by a number of factors: psychological (business executives do not consider preserving life and health of employees to be the most important tasks in their business), financial (not sufficient financing for preventive measures), legal (the regulatory framework needs to be refined, both in terms of improving the quality of existing regulatory acts and in developing the new ones). In doing so, the financial factor is closely linked to the psychological one. Regarding the legal factor, its connection with the psychological one manifests itself in the fact that employers can regulate the issues of labour safety locally, if desired, without waiting for development at the government level.

This article proposes to create conditions for development of innovative production technologies by scientists in Ukraine, which will make the working conditions safer. This is interesting and profitable for business - no need to pay for foreign products, and for the state - since job creation reduces the number of people receiving unemployment benefits and increases the number of taxpayers. This also benefits workers with ability to earn money at home without leaving families in search for jobs in other countries.

Advisability of reviewing the economic aspect is also emphasised: comparing gains and losses from work (termination of work) in harmful working conditions (both employers and the state). It is also proposed to provide a mechanism for compensation for employers who have reduced the number of jobs in production with harmful factors (to set a norm providing for example, if within 5 years there are new jobs in this production with harmful working conditions, then the indexed compensation has to be returned in proportion to the number of jobs created harmful working conditions). It is also necessary to complement the Procedure by imperative norm for involving a territorial body of the State Labour Service in a sectoral direction into a special commission and commission for investigation of industrial accidents.

These are not single proposals required by legislation, for instance, the Procedure and other legal acts are needed to be revised in part, concerning the mechanism of implementation of proposed changes and norms, which adapt the current legislation to the new subject composition of insured persons. This may be the subject for research in the following scientific papers.

References

1. Zatsarnyy V.V., 2015. Modern approach to safety management. *Problems of occupational safety and health, industrial and civil safety. Handbook of conference material*, 475 p.
2. Serdyuk V.R., Mymryk L.V. *Social and economic aspects of occupational safety and health*.
3. The General Report of The Coal Industry Supervision Division on The State of Occupational Safety at Coal Enterprises for 2017. [online] Available at: <http://dsp.gov.ua>
4. Legal thought of University of Saint Volodymyr. V.A., 2009. Udintsev. *Russian mining law*, 231 p.
5. On Compulsory State Social Insurance, approved by the Law of Ukraine as of 23.06.1999 №1105. [online] Available at: <https://zakon.rada.gov.ua/laws/show/1105-14#n175> [Accessed 29 May 2019].
6. On Adoption of Procedure for Investigating and Accounting Of Industrial Accidents, Occupational Diseases And Industrial Crashes, approved by the order of Cabinet of Ministers of Ukraine as of 17.05.2019 №337. [online] Available at: <https://zakon.rada.gov.ua/laws/show/z2y2019> [Accessed 29 May 2019].
7. Conception of Reforming of Coal Industry In Ukraine, approved by the order of Cabinet of Ministers of Ukraine as of 14.05.2008 N 737. [online] Available at: <https://uk.wikipedia.org>
8. Vorotnikov A.V., 2008. Economic benefit from occupational safety and health measures. *Safety and occupational safety and health* [online] Available at: <http://www.biota.ru>
9. Handzyuk M.P., 2008. Basics of occupational safety and health, 384 p.
10. Rons'ka O.G., 2019. Methodology of display of labour protection costs in managerial accounting. [online] Available at: <http://aphd.ua/publication-35/> [Accessed 16 May 2019].
11. Safety of work on deep coal horizons, 2019. *Industrial safety – Ukrainian industrial and practical magazine*. [online] Available at: <http://www.prombezpeka.com>
12. General demands, concerning employer providing of occupational safety and health to employees, approved by the order of Ministry of Emergency Situations of Ukraine as of 25.01.2012 №67. [online] Available at: <https://zakon.rada.gov.ua/laws/show/z0226-12>
13. Stashkiv B.I., 2016. Social maintenance law, 692 p.
14. Didkovskaya T.O., 2007. Essence and meaning of works with harmful and difficult working conditions. *Legal forum*, 1, pp.50-53.
15. Kuchma O.L., 2016. Problems of theory of legal regulation of social insurance in Ukraine. *Education in Ukraine.*, pp. 208-209.
16. About adoption of Provision about service of insurance occupational safety and health experts, prevention of industrial accidents and professional diseases, approved by the order of board of the industrial accident and occupational disease compensation insurance Fund as of 20.12.2011 №63. [online] Available at: <https://zakon.rada.gov.ua/laws/show/z0066-12#n13>

Konstantin Bogomaz

*Head Department of Sociology, Doctor of History Science, Fool Professor
Dniprovsk State Technical University, Kamyanske, Ukraine*

Yurij Kravtsov

*Professor of Department of Sociology,
Doctor of Philosophy Science, Associate Professor,
Dniprovsk state technical university, Kamyanskoe, Ukraine*

**THE PURPOSE OF PHILOSOPHICAL CULTURE IN FORMATION OF THE
FUTURE ENGINEER'S THINKING**

***Abstract.** In the article, the authors consider education as a decisive condition for the formation of key personality competencies. The issue of the humanization of technical education is very relevant today. The authors believe that the generation of a technogenic type of culture leads to the spiritual impoverishment of the individual. There is a dehumanization of education, which turns into the development of future engineers only professional skills. The authors believe that the restriction of the humanitarian cycle of disciplines in technical universities casts doubt on the possibility of training engineers who combine high professionalism with well-developed communicative competencies. Particular attention is paid to the place and role of the study of philosophy, which, according to I. Kant, poses its task so that "a person has the courage to live with his own mind." The authors reveal the content of the concept of the human factor - that means, first of all, to understand a person, enter the world of his interests, needs, expectations, comprehend many of his actions. , i.e. see his personality. The authors proceed from the fact that the selection of competencies at the moment remains one of the urgent problems of education in the context of a competency-based approach. Accordingly, the purpose of education is related to the formation of key competencies (competencies). It is concluded that the positioning of education (primarily professional) in the field of social meanings depends on the competence content of education.*

1. The role of philosophy in creating a technical picture of the world

It has been known since Socrates that the core of creative thinking is positive skepticism: "I know that I don't know anything" (lat. Scio me nihil scire) and "Know thyself" (lat. Cognosce te ipsum) - rationalism consisting in the correspondence of the subject to your concept. The authors of the article believe that these Socratic principles mean the desire of a person to improve both himself and reality in accordance with his ideal and on the basis of philosophical culture. Philosophy, regardless of affiliation with materialism or idealism, both historically and logically is the first form of rational-logical way of thinking. Philosophical thinking has shaped and is now forming a logically consistent, evidence-based understanding of objects in the sphere of human practical activity and determines the essence of his vision of the surrounding reality. The above features of philosophical thinking allow us to consider the emergence of philosophy as a quantum leap, an intellectual revolution in the history of the development of human thinking. K. Jaspers rightly called philosophy one of the main elements of the axial time of human history. The philosophical culture of personality is a complex and multifaceted phenomenon. Depending on the aspect of consideration, it distinguishes various characteristic features. We will focus on the three most significant, in our opinion, components of philosophical culture, affecting the formation of a special form of social consciousness - technological: worldview, culture of thinking, methodology. First of all, we define what we mean by each of these aspects as components of philosophical culture. The worldview, as you know, is the basis of man's attitude to the world, to reality. It mainly performs cognitive and regulatory functions, reveals the place and role of man in the world, the

meaning of his being. In the framework of this article, we will talk about a scientific worldview, believing that an ordinary worldview (also called “flat”) cannot serve as a characteristic of philosophical culture, although there is a relationship between these two levels (scientific and everyday). Take, for example, the worldview of a scientist. In his field of science, he has a truly scientific worldview, and in relation to other areas of life and activity, his worldview may be mundane. From this point of view, the scientific and everyday worldview can be considered synonymous with scientific and everyday consciousness.

Regarding the definition of a culture of thinking, we consider it sufficient that mastering the principles of dialectics or an integrated system of socially determined regulators, methods of cognitive activity is what is called a culture of thinking. By methodology, we understand the ability of a person to develop a universal free from historical contingencies attitude to the world. The basis of this relationship are the real processes of historical development of social forms of practical and spiritual activity of people. The presence of philosophical culture is not the privilege of only professional philosophers, but an integral part of the spiritual activity of each subject.

When considering the role of philosophy in a person’s spiritual life, it should be noted that “philosophy not only summarizes the results of science, but also“ melts ”them in the context of a complex problematic associated with a general understanding of the nature of knowledge, with understanding the place of science in the cultural system, with science to practice, etc. Synthesizing knowledge of the world (nature, society, history, man) with ideas about the relation of man to the world and the world to man, philosophy reveals the place and role of man in the world, the meaning of his being. Philosophy is an atom that is constantly developing the ability to identify and comprehend those norms of any type of human activity that are objectively set by the historical development of society. Philosophy is characterized by a reflex orientation that distinguishes it from all other types of knowledge.

The progress of concrete scientific, scientific and technical knowledge stimulates the growth of the philosophical consciousness, which is becoming more and more necessary for the scientist himself in their scientific activity. A person must know not only the laws of nature, but also the laws of the "artificial world", the laws of the system of technology created by him. Moreover, we can no longer talk about the so-called "primordial" natural environment. As a result of centuries of technological activity, man has created a new environment for his dwelling, gaining global proportions - the technosphere. Therefore, it is legitimate to talk about one more special picture - the technical picture of the world. In the formation of the technical picture of the world, a special role belongs to a specific field of knowledge - technical knowledge. Today it can already be argued that knowledge of the world of technology, of the technosphere has penetrated so deeply into the consciousness of people that they leave an imprint on all ideas about the world. Technical Knowledge. - this is the “eye” through which a person looks at the world, this is a system of knowledge about the world through the prism of knowledge and ideas about technology.

The role of philosophy in the formation of a technical picture of the world is manifested in the fact that philosophy represents the means of categorical synthesis, performing a methodological function. For a number of years, the literature discussed the status of the concept of "philosophy of technology" proposed by Engelmeier back in 1910. It seems that it would be more correct to talk about the philosophical problems of technology. We believe that Technological Knowledge and the philosophical problems of technology complement each other. Technical knowledge includes the whole range of knowledge about technology, about technical reality, both theoretical and everyday. But only within the framework of the philosophical problems of technology, using a philosophical

categorical apparatus, “driving” this knowledge through the worldview, determining a person’s attitude to the technosphere, it is possible to obtain a holistic view and understanding of the technical picture of the World(TPW). Studying TPW, we are not dealing with a formalized structure of knowledge, but with a cultural phenomenon that can be represented as a specific component of the worldview. The scientific picture of the world and worldview are two phenomena of consciousness. Science, studying the phenomena of reality and the practical activity of people, develops with the help of philosophy a system of concepts, principles, ideas - these are the bricks from which the NKM is built, and in its composition - the TKM. The help of philosophy lies not only in providing a categorical apparatus and using universal laws of development, but also in the fact that the created image of the world receives a worldview color. In the formation of a scientific worldview, we see one of the most important tasks of philosophical culture. The worldview of any person is formed in the process of its upbringing and development in a certain natural and social environment. The task of science is to reveal more deeply the mechanisms of human behavior in this environment and, on this basis, to find scientifically sound and affective ways to form a scientific worldview. In our opinion, it is part of the worldview structure as part of the scientific picture of the world. It is legitimate to ask the question, where are the new relations directly reflected in the system "society - nature" that have developed as a result of material and practical activity in conditions of industrial production? In our opinion, not one of the existing forms of social consciousness has as its object exclusively technical reality and social relations arising in the process of its creation and development. Therefore, we raise the question of highlighting a special form of social consciousness - technological. The very statement of the question of isolating this form of social consciousness seems discussion, but we will give a number of arguments giving the technological form of consciousness the right to exist.

The basis of technological consciousness as a special form of social consciousness is knowledge from various fields of activity - natural-scientific, economic, political, and actually industrial. Their ratio largely determines the ideological and methodological positions of the subject. The technical picture of the world includes two levels: theoretical and everyday. Each of these levels corresponds to a certain level of technological consciousness, i.e. what I. Kant called reason and reason. At the theoretical level, TCM is a kind of model of the world of technology, it includes a system of methodological principles derived on the basis of technical and technical sciences, it is a conceptual core that determines the nature of the problems solved in individual theories. And at the same time, the Technical picture of the world is a phenomenon of everyday human consciousness, it includes elementary representations of people about the world of technology, their emotions and feelings generated by technical reality.

Mastering the philosophical culture of thinking is an important link in the formation of technological consciousness. In this case, it is necessary to once again emphasize the role of philosophical reflection. The latter is aimed at the individual's awareness of himself and the norms of his activity, on the totality of the initial guidelines that determine man’s attitude to the world in general, and in our case, to the world of technology, and his place in it. The result of this awareness should be the achievement of a philosophically competent level of thinking. Within the framework of the theoretical level of technological consciousness, mastery of the culture of thinking is specific and manifests itself in the formation of a culture of engineering thinking. Engineering thinking is its form of selective reflection of reality. From the set of information and facts, the engineer selects only the information necessary to solve the technical problem, and at the same time excludes unnecessary information in this regard. Then he mentally “transforms” the existing technique,

varies various empirical models and, as a result, creates a new technique. The higher the level of philosophical culture of the engineer's thinking, the richer his imagination, the brighter his creative abilities appear, the more productive his activity becomes. But we must make a reservation that the engineer himself is far from always guessing how much he needs to master philosophical culture. If of technology and the laws of its development are a way of reflection within the framework of technological consciousness, then they, in turn, create a certain way of thinking. Operating in the minds with such concepts as "mechanism", "construction", etc., including in the adoption of judgments and conclusions, additional conditions taken from reality or technological practice, a person creates a special way of seeing the world, which I call engineering thinking. It is a specific alloy of all the components of philosophical culture that we have identified. We assign a special role to the culture of thinking in the formation and development of productive engineering thinking. Reproductive engineering thinking is aimed at the reproduction of already known knowledge, and usually this type of pressure dominates during the mass production process, does not contribute to the emergence of fundamentally new designs. Productive thinking involves the rejection of clichés, it is not intended to acquire new knowledge, to create new systems from already known elements and to find new elements of the technological process. Therefore, the element of creativity is especially great here.

The development of productive engineering thinking implies the ability not only to freely operate on well-known principles, but also to see new structural levels of the thinking process itself. In other words, in the broadest sense of the word, mastering the culture of engineering thinking presupposes the subject's ability to apply the scientific-dialectic approach when solving the engineering problem. In this case, it is appropriate to quote T. Edwards, the founder of Wilson College in the USA: "The great goal of education is rather to discipline the mind than to clutter it with various knowledge, to train the mind to solve an independent task, than to fill it with what has been accumulated by others" Indeed, at the present stage of the development of science and technology, in a situation where the knowledge acquired by young specialists at a university becomes obsolete in 3-5 years, it is necessary to develop, first of all, the ability of future engineers to think dialectically, creatively. Thus, our analysis allows us to say that philosophical culture acts both as a reflection and reflection in a theoretical form of the entire spiritual culture as a whole. Studying the real philosophical and philosophical preconditions and the principles of practical and cognitive activity of people and, accordingly, their reflection in the consciousness of the individual, philosophy seeks to identify the general foundations of culture, to develop a holistic view of the world and the place of man in it. Detailed worldview synthesis can be carried out only within the framework of philosophy.

2. Humanitarian component formation communicative competences of students of the technical university

Analysis of creation at different levels of education development allows us to allocate general and special in its content. First of all, general here is the fact that all civilizations of the past and modern world have acted and act as an information process, that is, they produce information about both natural reality and the various spheres of society being in the course of cognition and public practice. Special is the methodology of knowledge transfer and assessment of their understanding and learning. About the dialectic of general and special in the content of education reflect the facts of the paradigmatic settings changes in its content. The logical grounds for their change are the constant process of knowledge increasing and developing; and ways to improve human practice during the

objective reality knowledge process, and the methodology of the new knowledge transmission in the system of subjects-subjective relations in the educational process and so on.

The quality of education, as its internal certainty, definitely reflected the changes in content and purpose in different historical paradigms. In philosophy, quality reflects the persistent relationship between the components of an object, which characterizes its specificity that makes it possible to distinguish one object from another. It is thanks to the quality each object exists and conceived as something separated from other objects. Today, in the context of the information and telecommunication paradigm, the quality of education is expressed by the fundamental learning of the student-subject the content of information and communication technologies as a determining system of knowledge, and, of course, the use of telecommunication means of knowledge updating.

The establishment of information and communication technologies transforms the face of the entire education system. This is due to the fact that today the new ways of information reporting to the subject of education are being widely introduced in education. This has not only expanded the area of distance education as a complex of educational services. Information technologies acted as the basis for the formation of a common educational space.

To answer the challenge of information technologies, the education philosophy should take care of its ontological support. In the new information and telecommunication paradigm the relationship of information and communication became the foundation for explaining the essence of communicative rationality. The epistemological value of post-neo-classical rationality was the concept of communicative rationality. And all the main epistemological values of the process reveal their meaning precisely in the prism of their rational comprehension. In education, the content of communicative rationality is most clearly revealed. The presence and substantiation of the support of subject-subjective relations in the educational process give the right to claim that through this system of relations the essence of this type of communication is revealed.

An example of ontological work in pedagogical practice is "social design", which offers a new way of existing educational practices understanding and opens up new ranges of possibilities. Rationalization of knowledge by its nature is intentional, since it is always the concentration of the subject over "something", with the help of a certain methodology. This is a creative search for truth. In the educational process, the solution of this problem is the communicative connection of its subjects, but this connection is the deepest reflection of communicative rationality.

Analysis of creation at different levels of education development allows us to allocate general and special in its content. First of all, general here is the fact that all civilizations of the past and modern world have acted and act as an information process, that is, they produce information about both natural reality and the various spheres of society being in the course of cognition and public practice. Special is the methodology of knowledge transfer and assessment of their understanding and learning. About the dialectic of general and special in the content of education reflect the facts of the paradigmatic settings changes in its content. The logical grounds for their change are the constant process of knowledge increasing and developing; and ways to improve human practice during the objective reality knowledge process, and the methodology of the new knowledge transmission in the system of subjects-subjective relations in the educational process and so on.

The quality of education, as its internal certainty, definitely reflected the changes in content and purpose in different historical paradigms. In philosophy, quality reflects the persistent relationship between the components of an object, which characterizes its specificity that makes it possible to distinguish one object from another. It is thanks to the quality each object exists and conceived as something separated from other objects. Today, in the context of the information and

telecommunication paradigm, the quality of education is expressed by the fundamental learning of the student-subject the content of information and communication technologies as a determining system of knowledge, and, of course, the use of telecommunication means of knowledge updating.

The establishment of information and communication technologies transforms the face of the entire education system. This is due to the fact that today the new ways of information reporting to the subject of education are being widely introduced in education. This has not only expanded the area of distance education as a complex of educational services. Information technologies acted as the basis for the formation of a common educational space.

To answer the challenge of information technologies, the education philosophy should take care of its ontological support. In the new information and telecommunication paradigm the relationship of information and communication became the foundation for explaining the essence of communicative rationality. The epistemological value of post-neo-classical rationality was the concept of communicative rationality. And all the main epistemological values of the process reveal their meaning precisely in the prism of their rational comprehension. In education, the content of communicative rationality is most clearly revealed. The presence and substantiation of the support of subject-subjective relations in the educational process give the right to claim that through this system of relations the essence of this type of communication is revealed.

The value of the individual, the human factor in the system of social, economic, industrial, scientific, technical, organizational-managerial and other relations, in the development of culture, moral ties between people, in the family, in everyday life is constantly increasing as society develops. The hope that society is interested in the development of its forces and abilities, that it will encourage people creative, able to act on their own, those who have their own opinions and boldly take great responsibility, does not leave the person and in the difficult conditions of the present, constantly is changing. Accordingly, the purpose of education is correlated with the formation of key competences. At present, the most actively discussed issue of communicative competence in two contexts: linguistic and psychological-pedagogical. Many works are devoted to language communicative competences [Yu. Habermas, M. Halliday, N. Khomsky, J. Raven, A. L. Andreeva, L.F.Bachman, R.H.Bell, I.L. Bim, E.V.Vasina, T.M.Dride, P.Duyer, N.O.Epihina, Yu.M. Zhukov, Yu.L. Karaulov, VN Kashnitsky, GA Kitaigorodskaya, OG Polyakov., I. O. Zimnya, L.L. Shabalina, AV Khutorskaya, G. Selevko, OI Pometun, R. Pastushenko, OV Ovcharuk, etc.], and the essence of the development of communicative competence from a psychological and pedagogical point of view is determined only by some scientists (Mutovkin O .M., Burtova NB, Sidorenko GA, etc.). Note that the article does not aim to analyze the concepts of "competence" and "competence". These studies were reflected in numerous works by Ukrainian and foreign philosophers, sociologists, and educators. By "competence" we will mean a range of issues in which a person is well aware, possesses knowledge and experience. A person competent in a particular field possesses the relevant knowledge and abilities that enable him or her to reasonably judge this area effectively to act in it. Competence is most often interpreted as an intellectually and personally conditioned experience of a person's socio-professional life activity based on knowledge [6] and necessary for effective activity in a given subject area. Well-known Russian researcher AV Khutorsky differentiates the notion of "competence" and "competence" as general and partial, referring to the competence of some alienated, pre-set requirements for the educational preparation of the student, and under the competence - his personal qualitative characteristics that have already occurred [10]. In the general form, competence is the possession of an appropriate competence, that is, a set of interrelated personality traits (knowledge, understanding, skills, relationships) that are

established in relation to a certain range of subjects and processes, for productive action with them. Competencies are often seen as a person's conscious ability (ability) to realize knowledge and skills for effective activity in a particular situation, that is, competence is an alloy of traditional knowledge, skills and abilities with the personal characteristics of the student, with his self-awareness, reflection in the course of cognitive activity. To separate the general and individual in the content of competency education, the terms "competence" and "competence" are used synonymously. Competence is a set of interrelated personality traits (knowledge, skills, skills, modes of activity) that are given in relation to a certain range of subjects and processes and necessary for qualitative productive activity in relation to them.

By "competence" we will mean a range of issues in which a person is well aware, possesses knowledge and experience. A person competent in a particular field possesses the relevant knowledge and abilities that enable him or her to reasonably judge this area effectively to act in it. Competence is most often interpreted as an intellectually and personally conditioned experience of a person's socio-professional life activity based on knowledge [6] and necessary for effective activity in a given subject area. Well-known Russian researcher AV Khutorsky differentiates the notion of "competence" and "competence" as general and partial, referring to the competence of some alienated, pre-set requirements for the educational preparation of the student, and under the competence - his personal qualitative characteristics that have already occurred [10].

In the general form, competence is the possession of an appropriate competence, that is, a set of interrelated personality traits (knowledge, understanding, skills, relationships) that are established in relation to a certain range of subjects and processes, for productive action with them. Competencies are often seen as a person's conscious ability (ability) to realize knowledge and skills for effective activity in a particular situation, that is, competence is an alloy of traditional knowledge, skills and abilities with the personal characteristics of the student, with his self-awareness, reflection in the course of cognitive activity.

To separate the general and individual in the content of competency education, the terms "competence" and "competence" are used synonymously. Competence is a set of interrelated personality traits (knowledge, skills, skills, modes of activity) that are given in relation to a certain range of subjects and processes and necessary for qualitative productive activity in relation to them. Competence is the possession of a person's relevant competence, which includes his or her personal relation to him and the object of activity.

The purpose of the study is to show that the selection of competencies, especially their humanitarian component, remains one of the pressing problems of education in the context of the competence march. Accordingly, the purpose of education is correlated with the formation of key competences. The solution for each person of "eternal" problems implies his certain philosophical culture, knowledge of basic philosophical issues, fundamentally possible answers to the fundamental questions of being, knowledge of forms and ways of entering into all new and new realms of reality, transition to new ways of activity. Many household renewal problems are born of a lack of culture in the broadest sense. The philosophical culture of the individual is one of the essential components of the general human culture, one of the undeniable assets of the human personality.

This issue is of particular relevance in technical universities, where in connection with the prevalence of subjects of the technical cycle, professional communication training is needed, the foundations of which are laid on the junior courses in the process of studying the humanities. The issue of the humanization of technical education is very relevant today. Generation of technogenic

type of culture leads to spiritual impoverishment of the individual. There is a dehumanization of education, which turns into the development of future engineers only professional skills. In this connection, the issue of the development of the personality of a specialist in the technical sphere, in which high professionalism is combined with the developed communicative competences [5, p. 33].

Of particular importance, in our view, in this situation, should be given to the ideological purpose of the course of philosophy, which today is practically taken out of the educational process. The current philosophy program requires the student to learn many outside perspectives on the outside world without asking "Who am I", "In which country do I live?", "Can I change anything?" However, these questions may arise if the future engineer is given the opportunity to become familiar with the philosophy of Plato, Kant, or Hegel, with Marx and Heidegger. Most of the students, who are not interested in the issues of the world and the place of the person in it, are the ones who need an explanation of the real state of affairs and those issues that academic philosophy says. I. Kant considered that the main task of philosophy was that "man had the courage to live his own mind." Those who oppose such a task of philosophy, either do not report their call, or want to deny man his desire to be human.

Modern mass culture imposes on a person a pattern of existence when a person uses ready-made solutions and follows a system of pattern patterns. One does not have to choose, to take responsibility for, they have already defined everything, there is no need to think about how to act in one or another situation, since the creators of mass culture have already defined the "corridors" of behavior, following which a person becomes dependent on Fashion, Success, Glamor, Glory, Wealth. The concept of Liberty in this case is completely saturated with hypocrisy. The modern man is no longer capable of thinking on his own, he is happy to "run from freedom" of choice, adopting totalitarianism when all decisions are made for him. The whole course of history shows that the cause of fascism and Bolshevism is the inability of man to think independently. The only weapon against totalitarianism - is capable of thinking independently. It's a civil society person. Today, there is no civil society in Ukraine, however, it was not there yesterday. Philosophical centers in different historical times appeared in Germany, France, England and the USA. In these countries, there is still a strong philosophical tradition and civil society that are organically linked. Unfortunately, this link is incapable of understanding the newly emerged "reformers" in the field of education who are trying to protect engineers today from the study of philosophy, do not want civil society to be formed in Ukraine, and it is not clear at all what they want. The need for creativity in the work of an engineer cannot be denied. Like any creative person, he creates in the outside world. And so he just needs to realize his place in this world. This is the meaning of his work when, in solving specific tasks, he correlates these decisions through the "world as a whole" in order to build them on a certain part of the world. A narrow specialist, in the absence of such a view, simply does not see what is happening next to him, does not own the situation in a broad sense, such an expert ceases to own and himself

Quality assurance issues and performance appraisals are included in the area of competence: who does something good or bad can be measured against certain criteria or standards. This also includes the ability to manage the situation (even unforeseen)

L.A. Petrovskaya notes that "in the broadest sense, competence in communication implies the development of an adequate orientation of the person in himself - in his own psychological potential, the potential of a partner, in the situation and the task" [8, p. 439]. Communicative competence is formed, above all, in the activity and directly related to the development of the individual. In turn, the level of personality development influences different aspects of

communication and its effectiveness. The condition of normal, productive, moral external communication is the formed capacity for internal dialogue [7, p. 106]. In the process of reflection, new information becomes appropriated and transforms into one's own knowledge. It is possible to amplify this "effect" by using reflection to form professional and personal competences and as one of the strategies of higher education. During the dialogue, some of the opponents' considerations may be quite acceptable for acceptance as their own, while others require discussion. In any case, this reflection actively promotes the development of critical thinking skills [4, p. 138].

K. Rogers characterizes the essence of reflexive learning as a way of marking one's doubts, trying to clarify unclear questions and thus approaching the meaning of a new experience [3]. Tracking the stages of their activities helps the student to understand the methodology of educational cognition. It is through reflexive, inherently philosophical knowledge that the competence structure includes skills, knowledge, experience, contacts, values, and of course, coordination of all these elements and control over the whole process management system as a whole.

The utilitarian thinking of modern society is practically without any view of its own. A person who has his own view, that is, a personality, is an anomaly for the state. Thus, a paradoxical situation arises when the present student is a future engineer, forced to give up the desire to be a person. It is understandable that a modern young engineer is not only a specialist in his field, but also a person living in other fields. If he wants to be a broad-minded person, to have his own opinion and to be able to make responsible decisions, he will have to do without philosophy. And if an engineer becomes a scientist, then he is ready. And in general, the engineer goes not only to work but also to elections, reads not only the drawings but also the newspapers. How will he relate to what he read?

The communicative competence of the future engineer is the willingness and ability to interact, verbal and non-verbal (facial expressions, body language), with other people; it is the most important quality needed by specialists in all spheres of life [4, p. 33-34]. The limits of the concept of competence are dynamic. Changing boundaries depends on what aspect of competence the researcher will highlight. The English School of Competence focuses on the study of performance and performance, while the American school focuses on the people who perform the activity. For example, a teacher whose task will be to develop competencies in students will rather focus on whether competencies can be taught, while a staffing agency employee is more interested in assessing the current level of competencies in candidates.

Competitiveness in today's job market, where, according to IBM experts, a person changes his or her specialty at least seven times during a professional career, largely depends on his or her ability to acquire and develop skills, competences, or competencies that can be applied or to transform in relation to a number of life situations. The competence category is the result of a new economy and a new approach to human resources. It has arisen from the need for human adaptation to the all too often changing conditions in the modern world of an avalanche of information accumulation and obsolescence of previously acquired knowledge. Competent specialist is an individuality, autonomy that has the ability to realize and reflect on their own actions, to compare, evaluate themselves, to project the future [2, p. 23-29].

The traditional teacher-centered education system does not learn to think independently when the responsibility for the learning outcome rests not only with the teacher, but first and foremost on the student who is free to express his or her own position in the lesson, collaborating with classmates in the team, cares for the result in the process training [6, p. 19].

We believe that one of the main goals of higher education is to educate the student critically thinking and able to analyze. this is “thinking is evaluative, reflective. this is open thinking, which does not accept the dogma that develops by imposing new information on personal life experience ”[5].

Critical thinking is more concerned with statements and their justification, interpretation and application. The specificity of critical thinking was very clearly noted by American educator Charles Temple: "To think critically means to be curious and to use research methods: to ask questions and to carry out a systematic search for answers. Critical thinking involves polite skepticism, doubt in the accepted truths, the constant question: "What if?" Critical thinking is not a particular skill or skill but a combination of many skills ”[9, p. 39]. Thus, in the educational process, as in the form of communication of the subjects of this process, in the course of the truth development, the priority belongs to dialogue as value form in which the epistemological aspect of education is the most clearly revealed. The referring and the establishment to communication as to communicative factors – this is the condition of communicative rationality being, it expresses the holistic nature of the subject-subjective relations in education.

Conclusions.

Thus, the higher priority in education is not so much the acquisition of a large amount of knowledge by students and students, but the development of their intellectual and creative potential, which allows to produce new knowledge in the future. Within the teaching of social and philosophical disciplines, as a component of the educational process, there is a unique possibility of forming the competences of students corresponding to the new educational standard. Communicative competence implies a willingness to flexibly and quickly apply knowledge and experience to communication situations, including non-standard ones.

References

1. Babina S.I.,(2020)., *Actual Problems of Teaching Philosophy at a Technical University. Vplyv suspilnykh nauk na process rozvytku suspilstva: mozhlyve i realjne: Materialy` mizhnarodnoyi naukovo-prakty`chnoyi konferenciyi* (p.p.9-11) Kyiv (in Ukrainian).
2. Golovko N. V.,(2008) *Abductive conclusion and critical thinking: to the problem statement, Filosofija obrazovanija. № 1 (23–29)* [in Russian].
3. Gusinskij Je. N., Turchaninova Ju. I.,(2000) *Introduction to philosophy of educatio.* Moscow: «Logos»,224 [in Russian].
4. Zagashev I. O., Zair-Bek S. I.,(2003). *Critical Thinking: Technology Development* SantPetesburg: Alljans «Del'ta».264 [in Russian].
5. Zimniaia I. A.,(2008) *Key competencies are a new paradigm of the result of education* URL : <http://aspirant.rggu.ru/article.html?id=50758>
6. Ghrynevych L., Bryndza V., Dementijevsjka N., Shyjan R.,(2016). *New Ukrainian School: basic education standards:-Ljviv,34* (in Ukrainian).
7. Onishchik V. M.(2008) *Axiological basis of communicative competence university students. Filosofiia obrazovaniia. 2 (101–107).* [in Russian].
8. Petrovskaia L. A.,(2000) *The development of competency-based communication as one of the areas psychological assistan. Sotcialnaia psikhologiiia v trudakh otechestvennykh psikhologov. – SPb. : Piter, S.(438–453).* [in Russian].
9. Templ Ch.,(2002) *The development of critical thinking through reading and writing in higher education: strategies for use in any subject area]: Proekt RKMChP. – Niu-Iork*
10. Khutorskoi A. V. (2002) *Key competencies and educational standards. Internet-zhurnal «Eidos».* – URL : <http://eidos.ru/journal/2002/0423.htm>.

Vasil Telelim

*Doctor of Military Sciences, Professor,
Professor Department of Strategy National Security and Defense
National Defence University of Ukraine named
after Ivan Chernyakhovskiy, Kyiv, Ukraine*

Yuryi Prykhodko

*Candidate of Pedagogical Sciences, Associate Professor
Kyiv, Ukraine
orcid.org/0000-0002-8782-383X*

Vadim Shemchuk

*Candidate of Pedagogical Sciences
Head of scientific researches of the department
National Defence University of Ukraine named after
Ivan Cherniakhovskiy, Kyiv, Ukraine
orcid.org/0000-0001-8873-0443*

**CONCEPTUAL FOUNDATIONS FOR THE DEVELOPMENT OF MILITARY
EDUCATIONAL SYSTEMS OF LEADING NATO MEMBER COUNTRIES**

***Abstract.** In the article, military education is seen as an important component of ensuring the national interests and national security of the leading NATO member countries. These factors are the source of the functioning and development of military education as an integral part of the security and defense sector. This view departs from the traditional approach to military education, which was mainly concerned with the military and military-technical aspects of the use of the armed forces. The conceptual orientation of views and actions on the development and functioning of military education in the leading NATO member countries is determined and justified, with the following structural construction: ensuring the national interests and national security of the state; nationwide requirements for officer personnel; laws and principles of military education; goals of military education; military education system; general trends in the development of military education systems from leading NATO members-countries; financing of military education; educational and qualification requirements for military specialists; structure and content of military education; technologies for training military personnel; material and technical base of military education; quality control of military education; monitoring of military-educational activity, adjustment of the process of training of military specialists.*

1. Introduction

The military policy of the sovereign countries of the world, by their very nature and content, is an integral part of their overall policy of creating armed forces, training, deploying forces, military equipment and weapons to achieve certain goals. The military policy of states is aimed at protecting national security, national interests and is concentrated in their military doctrines, military strategies, military construction practices. Trends in the development of military and political situation in the world, measures to increase the combat capability of the armed forces of developed countries of the world, equipping them with modern models of weapons and military equipment, which are being tested in conflict zones and are constantly being improved, the nature of the occurrence of regional and local military conflicts, forms and methods of their troops (forces) application convincingly testifies that military force remains an important instrument of state policy.

The main tasks of Ukraine's military policy in the near future and in the medium term, as noted in the Military Doctrine of Ukraine, are: localization and neutralization in the shortest possible time of the military-political crisis in the eastern regions of Ukraine, preventing it from becoming a large-scale aggression; the elimination of unlawful armed formations and the restoration of full control of the state border of Ukraine; creating a coherent security and defense sector as a key element of the military security system; ensuring the enhancement of capabilities of the defense forces necessary to achieve military policy objectives; enhancing the capabilities of the national defense-industrial complex through the implementation of the latest military technologies; restoring the prestige of military service; prevention and effective counteraction to information and psychological influences of foreign states aimed at undermining the defense capability, violation of Ukraine's sovereignty and territorial integrity, destabilization of the internal socio-political situation, provoking interethnic and inter-confessional conflicts in Ukraine; reforming the Armed Forces of Ukraine with a view to achieving interoperability and technical compatibility with the armed forces of NATO member states, etc. (About National Security of Ukraine, 2018; About the New Edition of Military Doctrine of Ukraine, 2015).

The Strategic Defense Bulletin of Ukraine states that defense reform must meet the current needs of Ukraine's defense, enhance the capabilities of the defense forces, increase their readiness to perform assigned missions and participate in joint combat operations with NATO forces. One of the strategic goals set out in the Strategic Defense Bulletin of Ukraine is the professionalization of the defense forces and the creation of the necessary military reserve, which is a prerequisite for the formation of personnel potential of the Armed Forces of Ukraine and other components of the defense forces, staffing them with trained and motivated personnel, creation, recruitment, hold and deploy of the strategic reserve of the Armed Forces of Ukraine. Operational Objective 5.2 provides for "Improvement of the military education and personal training". At the same time, it is expected that the military education system will acquire practical training, implementation of advanced training methods of the NATO member countries' armed forces in the training process (Strategic Defense Bulletin of Ukraine, 2016). Achieving these goals requires increasing the effectiveness of the military education system of Ukraine, innovative educational and scientific activities of military educational institutions, ensuring the quality of education, reflection and implementation of experience in the development of military education systems, training of military specialists in the armed forces of leading NATO member countries.

2. Analysis of relevant research

The military education of the leading NATO member countries has accumulated considerable positive experience. Its creative study and generalization, critical analysis in the current context, should further enhance the effectiveness of military education in Ukraine, but this process should not be limited to identifying its achievements. Equally important is the prevention of repetition of other people's mistakes. Such a judgment is useful both for the objective assessment of the correctness of Ukraine's chosen path of reform and for the mechanism of further reform of the military-educational sphere. Deeply studying the experience of training military personnel in military educational institutions of leading NATO countries, one must realize that mechanical borrowing of the "best world models" can only hurt the cause (Zubko, 1997, pp. 7-30). It should be noted that due to the diversity and complexity of military education systems in the leading NATO member countries, comparative studies in this field are faced with the following problems: neglect of the need to thoroughly study the foreign experience of training military personnel; some obsolescence and lack of publications; incompleteness and insufficient analyticity of the source base; lack of acceptable criteria for generalizing the experience.

A number of publications by national and foreign authors have been dedicated to highlighting the experience of training military specialists in leading NATO member countries, in particular, the United States of America (Neschadim, 2003, pp. 157-163; Ozhgihin, 2013, pp. 19-26; Streletskiy, 2006) 20-27); The Federal Republic of Germany (Korchagin, 2012, pp. 30-39; Lazukin, 2008, pp. 26-30; Podgotovka of officer cadres of the German Army, 2016; Rumynov, 2014, pp. 24-34); France (Kolesov, 2006, pp. 26-32; Mitin, 2007, pp. 28-31; The official site of the combined forces of France); Great Britain (Brizhatij, 2012, pp. 20-25; Brovkin, 2005, pp. 11- Chernih, 2017, pp. 35); Turkey (Krymov, 2003, pp. 21; Tkachenko and Cherkov, 2013, pp. 15-21; Fedin, 1995, pp. 9-15).

This is due to the fact that the training of military specialists in these countries reflects the most prominent features of the modern approach to the creation of educational structures, their functioning, interaction with civilian universities, institutes and colleges, the organization of training and specialization of officers during military service. It should be noted that during recent years considerable efforts have been made in the military education systems of the leading NATO members-countries to improve the content of the training of military personnel, aligning with modern military art, combat using of the armed forces in certain versions, circumstances, and contextual situations, taking into account the generalized experience of peacekeeping, anti-terrorist operations, plans and actions of multinational headquarters (Prihod'ko, 2017; Chernih, 2017).

Some of the trends, problems and didactic principles of specialist training at NATO military training institutions have been reflected in the publications of a number of researchers (Ozhgihin, 2013; Tkachenko, Cherkov, 2013; Korchagin, 2012), namely: degree, continuity, self-organization in specialist training; integration of education and science; informatization, standardization of education, its personal orientation. The relevance and importance of improving the quality of officer training in the armies of the leading NATO members-countries in the context of the defense capabilities of the states, combat readiness and capability, development of military science and technology, weapons and their use, formation of the military elite, personal orientation of the military training environment, ensuring the competitiveness of military education in the international arena is highlighted in the works Neschadima M.I (2003), PrihodkaYu.I. (2017). At the same time, publications usually contain country-specific experience. Herewith the following systemic issues remain not enough coverage and generalization: management of military education; military education in the context of national security and defense of the state, its integration with civilian education; the structure and functions of the military education system, the legal framework for its functioning; network of military educational institutions; organization, didactics, content, informatization and technologies of training of specialists of different levels of education and links of military management; logistics, financing, etc.

The purpose of the article is to summarize the experience and to define the conceptual foundations of the development of military education systems of leading NATO members-countries.

3. Research methods

A system of general and specific methods of theoretical (analysis of publications by domestic and foreign authors, content of websites on the problem under study, analysis, systematization and generalization of the experience of training of officers in leading NATO members-countries, a systematic approach) and empirical research (systematic approach) and the empirical research (systematic approach) and the empirical research (using of statistics, diagnostic data, video surveillance of the training and activities of military professionals, generalization of results) were used to realize the purpose of the article.

4. Results and Discussion

World practice clearly focuses on the systemic regularity of the development of military education, the basis of which are protection of national interests and ensuring of national security of the state. These factors are the source of the existence and development of military education. This view allows us to move away from the traditional approach to military education, which was mainly concerned with the military and military-technical aspects of the use of the armed forces.

Based on the above, the conceptual orientation of the views and actions on the development and functioning of military education in the leading NATO members-countries has the following structural construction: national state interests; protection of national interests and national security of the state; national requirements for officer personnel; regularities and principles of military education; goals of military education; military education system; financing of military education; educational and qualification requirements for military specialists; structure and content of military education; technologies for training military personnel; material and technical base of military education; quality control of military education; monitoring of military-educational activity, correction of the process of training of military specialists.

National interests are realized through the following measures and actions:

protection of the territorial integrity of the state, allied countries and their citizens;

protection of interests affecting the welfare and well-being of the country, its citizens and the nature of international circumstances;

strong political, economic, diplomatic, information pressure, depending on the circumstances of the international arena under the slogans of democracy and humanitarian values;

carrying out actions of peacekeeping and humanitarian nature by contingents of international forces.

The national security of the state is one of the main tasks of all governments. The priority in ensuring national security is the presence and dynamic development of the armed forces, a high level of training of military professionals of different levels and links of military management. An indispensable requirement in the training process at military educational institutions, both personnel officers and reserve officers, is accounting and taking into account the goals and objectives of the types of military forces outlined in the military doctrine of the state, moral, psychological, material and other factors that take place during using the armed forces.

An analysis of the status and prospects of the development of the armed forces and the educational systems of NATO members-countries shows that they remain an important tool of national and block foreign policy, training military professionals capable of performing their tasks with high efficiency. The training of officers takes into account national security, based on the possibility of waging information war using different technologies, the occurrence of major regional conflicts, spread of various types of weapons of mass destruction in the world, destabilization of the situation in key regions of the world, terrorist acts and more.

Orientation of views and actions in the field of military education focuses on solving the problem of preparation countries and the armed forces through the principle of "reproduction" ("ability to reproduce"), what is meant by a complex of pre-planned measures that are needed to quickly reproduce the aggregate capabilities of the armed forces in different personnel categories and capacities of the defense-industrial base to a sufficient level.

Since the early 90-s. trends in military education in the world's leading countries have been clearly focused on information security. Existence in these countries of a powerful and

extensive system of information and telecommunication facilities and software products has made government and military authorities highly dependent on their reliability and survivability. Failure to manage or reduce the effectiveness of even some of its key components is seen as a serious threat to national security.

Military education, first of all, of the tactical level in all the leading NATO member-countries is a corporate system of training of military specialists whose purpose is to fulfill the tasks determined by the specificity of the functioning of the armed forces and the need for their application in specific conditions. At the same time, the main criteria for the requirements for military education remain valid: the state needs highly qualified military specialists, capable of commanding troops (forces) in combat (operations), training, education, development, psychological training of personnel in peacetime and war; to create, operate and apply the most sophisticated weapons systems and military equipment; accompany and carry out basic, applied research; to organize, carry out and supervise research and development works on advance creation of new generations of the armament, military and special equipment; to act effectively in carrying out tasks arising from the implementation of international counter-terrorism and peacekeeping operations, participation in the liquidation of local military conflicts, etc.

An important task of military education is also the development by officers of such functions of professional military activity that would correspond to universal human and democratic values. Without these bases, no trust between military and civilian parts of society is developed. As the tasks of special training can change depending on changes in society, the principles of conducting modern warfare and defense policy, the formation of the officer corps by decent representatives of its society is ensured by the constantly high requirements for officers of general character. The focus in military education is on developing: activity; creative approach; flexibility; critical analysis; ability to find and compile information; ability to exchange information; endurance in critical situations; willingness to take responsibility for the decision made, to accept criticism; the ability to ensure the unity of the following components: a thorough study of the circumstances, decision making, training of personnel, comprehensive support, organization of implementation, analysis of actions.

Recently there has been an increasing demand for the training of officers able to respond to the accomplishment of each soldier or unit tasks of an international nature that requires knowledge of international relations and international humanitarian law. The training of military personnel for the armed forces is based on the following basic tasks:

- ensuring that the likely adversary is effectively prevented from threatening, and, in the event of an attack on a state or its allies, striking it usually with a decisive collective action, and ultimately, defeat;

- qualitative enhancement of combat capability of troops (forces) while reducing the number of personnel due to: high-quality training of military personnel;

- increasing the capabilities of all forces and means of armed struggle;

- equipping weapons with high combat characteristics, modernization of weapons and military equipment; maintaining a balance (optimal proportions) between the types of armed forces, combat and providing, regular and reserve components;

- strengthening of military and political positions in different regions of the world through the development of possible theaters of war, conducting joint exercises, measures of operational and combat training;

– conducting small-scale operations to solve peacekeeping tasks, evacuate their citizens and local people from conflict areas, provide humanitarian assistance etc.

NATO forces are actively preparing for participation in the collective security and peacekeeping forces, which is why the practice of training officers in integrated military training institutions (Italy, USA, Turkey, Germany) takes place. For example, the US Foreign Personnel Training Program (IMET) aims to train foreign military personnel in accordance with US rules and regulations.

The main components of the military education systems of the leading NATO members-countries are: the regulatory framework; network of educational institutions at different levels and scientific and methodological institutions; governing bodies. These components interact with each other and with the external environment, based on certain laws, regulations and principles.

Their functioning is characterized by certain contradictions, which manifest themselves in the process of achieving the system of military education socio-state goals - as a system-forming element - and at the same time - a conscious image of the intended result.

The main goals of military education are:

- enhancement of the state's defense capability, the authority of the army in society, creation of material, intellectual and spiritual values;
- meeting the educational needs of the individual, society, and the state in the training of military professionals capable of effectively fulfilling the tasks assigned to them in peacetime and war;
- preparation of officers for independent activity as military representatives of the state while defending national interests beyond their borders;

In military education systems, there is a clear tendency to distinguish the general goals of training officer personnel from didactic ones, which are implemented in military educational institutions by their relevant specialties. At the same time, the common goals of military education in relation to didactics are given priority and are managed by all military educational institutions. From the point of view of a systematic approach to military education, taking into account national interests and national security, officers should consciously approach all political, economic, diplomatic and other decisions of the government, which are quickly designed and implemented in the educational process.

An analysis of NATO members-countries' military education systems and research in this field make it possible to identify the basic patterns of their development. The latter are essential for defining the strategic goal, tasks, major pathways and foundations of the creation of military education systems, the organization of training of military personnel, and the comprehensive providing of this process.

The regularities of military education are determined by:

- the educational needs of the individual;
- common national interests, national security and defense interests, public policy in the field of education;
- political, ideological and socio-economic conditions;
- scientific and technical capabilities of the state;
- national traditions, national and world experience;
- the needs of the troops;
- efficiency of managerial activity, coherence of functioning of all structural components;

- state of military-theoretical and psychological-pedagogical researches;
- the level of scientific and pedagogical potential and the state of infrastructure of military educational institutions;
- development of didactic bases for the training of military specialists;
- the state of moral-psychological, financial-economic, logistical and information support of the system.

The regularities of military education are closely related to its principles - as a certain system of basic requirements for the training of military specialists, the implementation of which should ensure the necessary efficiency of the system. Principles, arising from the laws of military education, determine its general orientation, purpose, content, organizational and methodological foundations, logistical needs.

The basic principles of military education include the following:

- unity of state policy on training of officers in military and civilian high schools;
- the priority of national interests and national security in the formation of the content of military education and requirements for military professionals;
- humanization and democratization of military education;
- the fundamentalisation, complexity, continuity, offensiveness and practical orientation of military education;
- liaison with the military, the proactive nature of military education in the use of troops;
- science, accessibility of education, taking into account age and individual characteristics of cadets (trainees);
- systematic and consistent training, awareness, activity, independence and creativity of training cadets (trainees);
- rational combination of collective and individual character of teaching on the basis of state ideology and practical psychology;
- selection of optimal technologies, forms, methods and means of training, control, monitoring and adjustment of the military-educational process;
- compliance of financial, information, logistical support of military education with the specified requirements for the training of officers.

Infrastructure, structure and content of military education. In the vast majority of countries, there is no clear graduation of military education institutions in terms of matching their names to the levels of accreditation and educational qualifications that take place in Ukraine. Therefore, institutes can be named as schools, military or military-naval schools, although they come from graduates of academies who have served for several years in various officer ranks, etc.

At the same time, such components of military education as basic military education (military lyceums, schools, military units, training centers), secondary military education (military schools, colleges, schools, academies, training centers, courses), higher military education (military universities and academies, courses). Officers of the widest range of specialties in primary positions are trained in officer schools, military colleges, military universities and academies, as well as in relevant courses at higher civilian educational institutions (universities, institutes).

There is also a steady requirement that officers must undergo advanced training or specialization training for each type of armed forces, troop and service school before each new appointment. The significant increase in the number of tactical officers trained in civilian schools

has led to an increase in the role of the system of training and retraining of officers, especially in the operational and strategic units of military management.

The educational process in military educational institutions has a clear tendency to divide into theoretical-applied military training and special military training. At the same time, as a rule, training of military specialists contains two components: on the territory of a military educational establishment and in training centers.

Military education is characterized by differentiation and individualization, although in different countries it is done differently: approximately from the 2-nd year of study – in the USA, from the 4-th year of study – in Turkey. The curricula imply high intellectual and physical intensification of the educational process, requiring the cadets and trainees to work very hard.

The direction of the work of military educational institutions is determined by the relevant directives of the military authorities, based on their personnel and scientific needs. The existing practice of functioning of multidisciplinary military educational institutions (especially for higher military education) allows to take care without difficulty of the training of military specialists for different types and sorts of troops. In this case, there are frequent cases of structural combination of basic engineering, technical and humanities faculties in one educational institution. There is a practice of widespread involvement of freelance lecturers, mainly leading specialists from central staffs and research organizations.

In many countries, after graduating from a military training institution of a type of armed forces or a civilian university, after being awarded the rank of "lieutenant"(or equal), continue training (specialization) in training centers military units (from several weeks in the United States to one year in Turkey).

There is a noticeable trend in the increasing need for fundamental training of military personnel to meet modern military and professional requirements when the decision-making process, the use of weapons and military equipment require a higher intellectual level of officers.

The content of military education is formed for a long term, reflecting the composition, condition, purpose, tasks of the types of armed forces and sorts of troops. Much attention is paid to integrated learning when integrated programs are being developed based on the integration of multiple disciplines. The accent is placed on the following issues: national security and national interests, operational and combat using of kinds of armed forces and types of troops, details, system and situational analysis, implementation of information, computer technology, humanitarian law, scientific principles of socio-economic development, management.

Real approaches to the structure and content of military education in each state are dictated, first of all, by practical necessity, based on one's own understanding of national interests, national security, tasks of the armed forces and economic opportunities.

The organization of officer's training is characterized by the following main dominants:

- strict selection of candidates for training in military educational institutions and an active system of deductions of those, who are incapable for military service;
- compliance of the content of specialist training with the job purpose, the current level of development of science and practice, the only scheme of organization of the training process: initial military training, training in accordance with the levels of education and military management (theoretical, practical), training and retraining (including higher military education);
- application of information and communication technologies, integrated educational systems;

- creation of optimal conditions for mastering knowledge, skills and abilities, careful control and monitoring of the quality of education;
- compliance of logistical, financial, informational, didactic support with the task of training military specialists;
- a significant increase in the number of officers from around the world studying in NATO military training institutions according to the relevant standards.

Training and material base of military education. The accent is placed on the fact that the training facilities provide not only the provision of theoretical and practical components of the educational process, but also for the scientific work of cadets and trainees, training of scientific-pedagogical and scientific personnel.

For engineering specialists, conditions are created for modeling technological processes, creation, testing and operation of weapons, military, special equipment in everyday and combat conditions. The training of officers of the operational and strategic links of the military administration provides opportunities to model processes that are related to solving problems of national security and vital interests of the state.

The practice of training graduates of military educational institutions for positions appointment in training centers (schools) types of troops, as well as the next retraining of officers, allows extensive using in the training process of the latest models of weapons and military equipment. Most often, these centers provide special training programs for cadets, officers in the study of armored vehicles, artillery, rocket and space weapons, aircraft, communications, intelligence, etc.

Officer training involves the study of international cooperation in the military and peacekeeping activities, focuses on the sixth generation of wars (using high-precision hypersonic missiles, weapons of mass destruction, robots, information technology, psychological factors etc.).

Much attention is paid to the organizational and methodological principles of military training, the application of innovative training technologies, integrated learning environments based on situation modeling, information multimedia, computer and training complexes. The training of trainees is conducted in small groups, which allows the teaching staff to pay a lot of attention to everyone who learns. The accent is placed on the independent work of cadets and trainees, who are responsible for the chosen profession, content and quality of their education. The system of studying the feedback of cadets and trainees about the activities of teachers is widely practiced. Cadets and trainees in educational institutions have the opportunity to receive the broadest and deepest educational information. Significant period of training in military educational institutions, future officers spend on military internships, and in the process of training or retraining, officers are involved in various military exercises. The system of involving cadets of senior courses for work with cadets of junior courses (first of all, the first) for the purpose of acquisition of command and methodical skills is practiced. Cadets are not distracted for housework, to wear daily assignments and watches, except for day patrols on the territory of the military educational institution to maintain order. Language training is limited to the fact that each officer is fluent in one of the foreign languages (mostly English), and in Turkey, even teaching is mandatory in foreign languages. The training of senior officers is usually carried out taking into account their specific position appointment. Business and professional qualities, as well as moral and psychological condition are formed in accordance with the requirements of officers of the military-political leadership of the state, thus allowing them to have a reliable support in the army and society.

National military education in the leading NATO members-countries is considered a source of intellectual and spiritual potential of the officer corps, which provides protection of the state and its national interests. The general trends in the development of military education systems are as follows: the implementation of the tasks of the armed forces to ensure national interests and national security; branching network of military educational institutions, training centers, training grounds; reliance on national culture, traditions and the best world experience in officer training; high efficiency of management of training of military specialists at all hierarchical levels, balanced integration with civilian education; advanced development of military education on the practice of daily activities of the armed forces; strict requirements for the quality of training of military specialists; continuity and gradual training and advanced training of military specialists of various categories; comprehensiveness and sufficiency of financial and logistical support of officer training; international cooperation in the military-educational sphere; entering the world market of military educational services.

5. Conclusions

Leading NATO members-states have an active and focused public policy in the field of military education. The basis of the latter is the protection of state interests, ensuring the national security of the state. An obligatory requirement in the process of training both personnel officers and reserve officers is the focus on the implementation of the goals and objectives of the armed forces, which are set out in the military doctrine of the state. National interests and ensuring the national security of the state are a source and a powerful factor in the development of military education. The training of officers takes into account the need to ensure national security, given the possibility of major regional conflicts and the spread of weapons of mass destruction in the world, destabilizing the situation in key regions of the world.

Military education, primarily of the tactical level, is a corporate system of training military specialists, the purpose of which is to perform tasks due to the specifics of the functioning of the armed forces and the needs of their application in accordance with adopted regulations and documents. The accent in military education is placed on developing future officers' activity, leadership skills, creativity, flexibility of thinking, critical analysis skills, ability to summarize information, share it, endurance in critical situations, readiness to take responsibility for the decision.

The effectiveness of the educational systems of the leading NATO members-countries is due to the fact that the most active use of this is political, diplomatic, economic, financial means, as evidenced by the own budgets of military educational institutions. Political and diplomatic efforts are justified not only by the high quality of officers' training, but also by the constant expansion of military training for foreign countries, which is well known to contribute to the growth of the country's international prestige. The role of officers is so high that the military-political leadership of NATO members-states does not consider it possible to make the most important government decisions without real participation in their training of military specialists.

The study is of practical importance for further reform of the Armed Forces of Ukraine in the context of modern requirements of legal documents on security and defense policy of the state, the course of rapprochement with NATO. Prospects for further research should be as follows: content, organizational, methodological and logistical principles of training military specialists of various links of education and military management.

References

1. Brizhatij Є.I. (2012). Porivnyal'nij analiz formuvannya profesijnoi gotovnosti oficeriv v armiyah providnih krain svitu. *Zbirnik naukovih prac Hmel'nic'kogo institutu social'nih tekhnologij universitetu «Ukraina»*. 20–25 (in Ukraine).
2. Brovkin V. (2005). Podgotovka voennosluzhashchih Velikobritanii. *Zarubezhnoe voennoe obozrenie*. 1. 11–16 (in Russian).
3. Zubko V.M. (1997). Comparative analysis of the reform as a precondition for the adoption of decisions. *Suchasni sistemi vischoyi osviti: porivnyannya dlya Ukrayini. K.* (in Ukraine).
4. Korchagin S. (2012). Sily spetsialnykh operatsii Bundesvera. *Zarubezhnoe voennoe obozrenie*. 3. 30–39 (in Russian).
5. Krymov I. (2003). Vysshie voennye uchebnye zavedeniya VS Turtsii. *Zarubezhnoe voennoe obozrenie*. 11. 21–25 (in Russian).
6. Kolesov P., Streletskiy A. (2006). Saint-Sire Special Military School of the French Armed Forces. *Zarubezhnoe voennoe obozrenie*. 6. 26–32 (in Russian).
7. Lazukin V. (2008). Podgotovka ofitserskikh kadrov v VS FRG. *Zarubezhnoe voennoe obozrenie*. 2. 26–30 (in Russian).
8. Mitin A. (2007). Uchebnye centry suhoputnyh vojsk Francii. *Zarubezhnoe voennoe obozrenie*. 6. 28–31 (in Russian).
9. Neschadim M.I. (2003). Military education in Ukraine: History, Theory, methodology, practice: monograph. K. : VPTs “Kiyivskiy universitet”, 852 p. (in Ukraine).
10. Ozhgihin V. (2013). Sistema podgotovki oficerskogo sostava suhoputnyh vojsk SShA. *Zarubezhnoe voennoe obozrenie*. 5. 19–26 (in Russian).
11. Oficijnij sajt zbrojnih sil Francii. URL: <http://www.defense.gouv.fr>.
12. Pro nacionalnu bezpeku Ukraini: Zakon Ukraini vid 21.06.2018 r. № 2469-VIII. (2018). *Vidomosti Verhovnoi Radi (VVR)*. 31. St.241 (in Ukraine).
13. Pro novu redakciyu Voennoi doktrini Ukraini: Ukaz Prezidenta Ukraini vid 24 veresnya 2015 roku № 555/2015 (2015). URL: <https://zakon.rada.gov.ua/laws/show/555/2015> (in Ukraine).
14. Podgotovka oficerskikh kadrov suhoputnyh vojsk Germanii. URL: <http://www.dogswar.ru/armii-mira/vooryjennye-sily/1152-podgotovka-oficerski.html> (in Russian).
15. Prihod'ko Yu.I. (2017). Aktualni problemi suchasnogo etapu rozvitku vijs'kovoï osviti. *Zbirnik naukovih prac' Nac. akad. ped. nauk Ukraini, Institutu ped. osviti i osviti doroslih "Osvita doroslih: teoriya, dosvid, perspektivi"*. 1(13). 275–282 (in Ukraine).
16. Rumynov D. (2014). Sistema podgotovki oficerov vooruzhyonnyh sil FRG. *Zarubezhnoe voennoe obozrenie*. 9. 24–34 (in Russian).
17. Strategichnij oboronnij byuleten' Ukraini: Ukaz Prezidenta Ukraini vid 6 chervnya 2016 roku № 240/2016: URL: <http://www.president.gov.ua/documents/2402016-20137> (in Ukraine).
18. Streletskiy A. (2006). System of training officers in the US. *Zarubezhnoe voennoe obozrenie*. 11. 20–27 (in Russian).
19. Tkachenko O., Cherkov V. (2013). Osnovnye napravleniya stroitel'stva vooruzhyonnyh sil Turcii. *Zarubezhnoe voennoe obozrenie*. 12. 15–21 (in Russian).
20. Fedin A. (1995). Training of officers in Turkey. *Zarubezhnoe voennoe obozrenie*. 8. 9–15 (in Russian).
21. Chernih Yu.O. Chernih O.B. (2017). Osnovi organizacii ta funkcionuvannya sistemi vijs'kovoï osviti Velikobritanii – analitichnij oglyad. *Zbirnik naukovih prac' "Vijs'kova osvita"*. 2 (36). 35–48 (in Ukraine).

Viktorii Stoika

*Doctor of Economics, senior researcher,
Transcarpathian Regional Centre for Socio-Economic
and Humanitarian Studies of NAS of Ukraine
Uzhhorod, Ukraine*

THE ISLAMIC BANKING: FEATURES, GLOBAL TRENDS AND OPPORTUNITIES FOR UKRAINE

Abstract. *The rules of banking management in Muslim countries are based on the Sharia Law, that is, a set of rules and laws relating to the management of the economy, social, political and cultural aspects of Islamic society. Sharia Law also prohibits the conclusion of immoral transactions and endorses social justice, which is ensured through the distribution of risks and returns, and the implementation of social investment. In the context of economic globalization, this phenomenon is already quite distinguished and is considered a worthy competitor to the traditional banking system. Features of Islamic banking institutions activities become their advantages in comparison with traditional banking institutions. That is why Islamic banks have become active participants in the global financial market, despite the specific nature of their operations and the difficulties of their adaptation to international practice. Islamic banking has spread not only in the developed countries of Western Europe, but also in Central Asia. The study of the process of Islamic banks activities in the financial markets of such countries as Great Britain, Germany, France, Kazakhstan and Uzbekistan allows us to identify two forms of their functioning: establishment of Islamic windows by banking institutions of these countries and direct entry of banks that originate from Islamic countries. The experience of the above-mentioned countries regarding the integration of Islamic banking into the national financial sector has shown, first of all, the need to develop an appropriate regulatory framework, to form an appropriate infrastructure, to conduct awareness-raising activities, to strengthen international cooperation with investor countries.*

Introduction

The term “Islamic financial system” is relatively new among scientific terms, since it has appeared in the mid-1980s. Often, this concept is understood as a financial system in which interest is not provided. However, the principles of Islamic finance are much broader than the rejection of loan interest. The rules of banking management in Muslim countries are based on the Sharia Law, that is, a set of rules and laws relating to the management of the economy, social, political and cultural aspects of Islamic society. Sharia Law also prohibits the conclusion of immoral transactions and endorses social justice, which is ensured through the distribution of risks and returns, and the implementation of social investment. In the context of economic globalization, this phenomenon is already quite distinguished and is considered a worthy competitor to the traditional banking system.

In today's world, there is an increased interest in Islamic banking and its products. Today, Islamic banks are actively integrating into European countries, as well as other non-Islamic states.

Taking into consideration the rapid development of Muslim banks all over the world, the study of the properties of Islamic banking functioning and the experience of foreign countries concerning adaptation of its instruments to the needs of the national economy is relevant and is of important theoretical and practical interest.

Trends and problems in the development of Islamic finance are now relevant topics of scientific researches. The following research and training organizations conduct different academic researches on this issue: Islamic Economic Institute (Jeddah), Institute of Islamic Banking and Insurance (London), Islamic Finance Academy (Dubai), International Centre for Education in Islamic Finance (Kuala Lumpur).

Also, the following authoritative international organizations as the Islamic Development Bank, the Accounting and Auditing Organization of Islamic Financial Institutions and the Council of Islamic Financial Services, the World Islamic Economic Forum, etc. study practical issues of the industry development.

The following works of such researchers as O. Abdelsalam [1], M. Abduh & M.A. Omar [2], R.K. Aggarwal & T. Yousef [3], R. Ayachi Ammar, M. Ben Slama & D. Saidane [4], T. Beck, A. Demirguc-Kunt, & O. Merrouche [5], M. Mohieldin [6], S. Ongena & I. Sendeniz-Yuncu [7], M. H. Rashwan [8], M. Djennas [9], J. Boukhatem & Ben Moussa [10] are devoted to the issues of Islamic Finance and Banking. In recent years, the growing interest in the specifics of Islamic finance and banking is observed among Ukrainian researchers, namely: B.I. Pshyk [11], N.M. Pantelejeva [12], O.M. Mozgovyj, O.V. Subochev, O.M. Jurkevych [13], S.L. Mykhajluta, N.A. Chuyenko [14], O.A. Chugajev, A.V. Cherednychenko [15]. Some aspects of the Islamic banking features were also highlighted by the author of the following publication [16; 17; 18]. However, the attention of the above-mentioned scientists is mainly focused on the features of the formation, development and tools of Islamic banking; while the problem of the Islamic banking model integration in the national banking system is still insufficiently studied.

The research in the field of Islamic banking is conditioned not only by bankers' interest in innovative financial products but also by a variety of interpretations of theoretical foundations of Islamic banking, as well as a discussion on the need to apply the experience of Islamic banks in the traditional financial system. The aim of the present article is to study the features of the development and integration of Islamic banks at the level of national banking systems.

The main methods of scientific knowledge and research of economic phenomena were used to achieve the desired objective, in particular, methods of theoretical generalization and comparison (to determine the specifics of Islamic banking), abstract and logical method (for theoretical generalization and conclusion). The theoretical and methodological basis of this study was the works of foreign and Ukrainian researchers, who study the activities of Islamic banks.

1. The features and financial instruments of Islamic banking.

The term "Islamic banking" means the conduct of banking operations in accordance with the principles of Islam. The main idea of the Islamic bank activity is that, since money is not a commodity, it cannot increase just because it was provided in the form of a loan. In fact, all transactions in financial institutions that operate under the Sharia Law principles are carried out on the basis of responsibility allocation and share participation of both parties – the one that takes the loan and the other that provides the loan. That is, the creditor can expect to receive income only if the money invested in the economy has created real added value. The reward of the bank or a depositor is not guaranteed, but is derived from the profit of the business. Naturally, the bank opens accounts, on which it accumulates funds of depositors and finances entrepreneurs by means of these funds. However, instead of paying the traditional interest, the entrepreneur shares the profit with the bank, which in turn shares with the depositor. It is obvious that under the following circumstances, Islamic banks are absolutely interested in the success of the debtor's business and getting profit, and therefore they choose borrowers with the utmost preciseness. A Muslim banker makes a decision on granting a loan primarily on the basis of studying the prospects of the project, which is proposed for implementation, as well as the business qualities of the borrower. At the same time, Islamic banks do not require the client to provide pledge.

The Islamic economic model is primarily intended to optimize the operation of each party's financial processes. To improve the effectiveness and addressing inequities in economic relations provide the main types of constraints [16, 18]:

1. The ban on usury. Rhiba (the surplus) is any unjustified increase of capital in the loan. Any transaction, which depends only on the term and amount of the deposit and not depends on the success of investments is prohibited because of rhiba. Thus, rhiba covers not only usury, but any interest in the usual traditional sense. The prohibition of rhiba is associated with the Islamic view on social justice, equality and property rights. Islam encourages profits only as a result of activities, leading to the formation of any final product, condemning the use of percent in profit.

2. Division of profit, loss or risk. Due to the prohibition of interest, capital owner is not a lender but investor. Thus, there is risk sharing between the owner of capital and the user of capital, as there is no guarantee of regular income. However, in case of success of the project, the investor participates in the direct distribution of profits.

3. Money as “potential” capital. The money will become capital only if it is invested in some business.

4. Prohibition of speculative behaviour. Operations based on the random event or speculation (in Arabic known as “maysir”) and not on the action of the parties aimed on generating income are considered to be invalid in Shariah. In this regard, in the Islamic financial system it is extremely complicated to use the derivative financial instruments which have significant risk level. The most of derivatives has no supposed delivery of real base asset, leading to the rapid development of speculation in the financial market. Buying shares with a relatively short holding period (exchange game) can be also attributed to speculation.

5. Sanctity of contract. The indefeasibility condition of the contract is the most important condition of the transaction.

6. Prohibition of uncertainty (gharar). When entering into a contractual relationship, the parties must fully disclose their intentions and information to each other, because the transaction that contains gharar will be prohibited. Any transaction where the subject of the transaction, the price or both are not defined and not fixed in advance will be considered suspicious by the Shariah. Islam condemns obtaining unilateral advantages by more informed party of the contract.

7. The ban on investments violating public interest. Investments inherently must comply with the principles of Shariah. Operations associated with certain types of products are prohibited; such products include pork, alcohol, arms, gambling and traditional fixed-income financial products. Islamic institutions can (depending on the views of the Shariah Council) to face challenges when investing in such activities as hospitality and entertainment industry. Also, the institutes have a black list of prohibited investments composed by the Shariah Council. The mechanism of Islamic capital market is somewhat different from the well-known capital market. Economic agents are guided not only by legal norms laid down in the legislation of the country, but also the rules prescribed in the Holy Scripture, the Quran. The transaction under Sharia law must meet six basic principles [17; 18]:

1. the interest is prohibited (“rhiba”);
2. the risk should be shared;
3. the speculative behaviour is prohibited (“maysir”);
4. use of asymmetric information is banned (“gharar”);

5. the contracts should be respected;
6. trade transactions allowed by the Islamic norms should be financed only, i.e. financing the Halal industries.

Consider the principle prohibiting the use of asymmetric information in the context of Western economic models and how this principle, which was announced by the Prophet Muhammad 14 centuries ago is applicable today. Gharar (literally, “danger”, “error”) refers to such a property contract/transaction, which causes deliberate or accidental omissions in the information by one or both of the parties, or party/parties cannot adequately interpret the purpose and expected outcome of the contract. Islamic view on gharar as information asymmetry is in its ethical interpretation, i.e. Islam condemns obtaining unilateral advantages by more informed party of the contract. Examples of a contract containing gharar are the next: purchase and sale of goods the seller do not possess now; the transaction without specifying the exact price, for example, with the phrase "current market price"; transactions using insider information, etc.

It is important to understand that Islamic economy does not formulate any special laws of economic development, but only alternative methods of doing business, and Islamic financial institutions, as part of the modern world economy, are characterised by the same economic laws as traditional (non-Islamic) financial market participants and partly affected by the same problems that arise in the West.

There is a wide variety of Islamic financial products available. Many of them have similarities, however, they are used in different purposes. For a more general presentation the most common of them discussed below.

Musharaka (from Arabic “partnership”) is a joint project of the Islamic financial institution and the entrepreneur. This product requires the signing of the partnership agreement between an Islamic financial institution and a customer, according to which both parties are funding the project together. Losses are divided in proportion to the participation of parties in the financing. The project may be funded by more than two parties. The project is being managed by all participants or by one of them. Musharaka contracts may be used for providing additional working capital for the company or for joint investments, for example, in real estate or agriculture. This type of contracts is used often to finance long-term investment projects.

The following financial instrument that is actively used by Islamic financial institutions is Mudaraba. Mudaraba is typically used to finance short- and medium-term investment projects (e.g. in retail trade). The Mudaraba contracts are analogous to trust-based financing in the traditional financial system. The income generated from the invested money is distributed between the financial institution and the entrepreneur in accordance with the agreement, concluded at the moment of signing the contract. At the conclusion of the contract, the parties determine proportion in which the profits will be divided, and not a specific amount of money (usually Islamic financial institution receives 15 to 30% of the profits). The financial institution solely bears losses in case they occur, and the mudarib (the trustee) in that case gets no reward for its efforts. The mudarib (the trustee) has no right to use the funds to finance other projects not covered by the contract without the permission of the client, and cannot attract other sources of funding or to use its own money.

Ijara is a copy of a lease transaction in the traditional financial system. It involves an agreement by which Islamic financial institution buys equipment, real estate, etc. at the customer's request, and then renting it to the customer. The duration of the lease and rent fee (fixed or time-varying) agreed by the parties.

Under Murabaha contract Islamic financial institution provides trade financing. Murabahais accompanied by a contract of sale of goods between the bank and its client at an agreed price. The bank buys the goods (raw materials, component parts, etc.) on behalf of the client, and then resells the goods to him, profiting from the sale of the goods, and also extra charge for services rendered. After signing the contract, the bank agrees to provide to the customer the goods, and the date and place of receipt of goods specified in advance. Before the goods are received by customer, the Islamic financial institution bears all risks of spoilage or damage.

The price of the goods should be determined in advance, and should specify the amount of markup, which is the reward. The client should pay the requested amount (usually gradually - in the form of an annuity payment) within a specified and fixed by the contract time period or as a lump sum. The margin for the bank's services can be specified in monetary terms or as a fraction of the cost of the goods, but must in no way be associated with time expressions ("weekly", "monthly", etc. are not allowed). The client in this type of transaction usually provides collateral to secure Islamic financial institution [18].

Thus, the Islamic banking system, like any other, is aimed at making a profit, but its main difference is the methodology and compliance with Sharia Law. There is a certain set of rules how to make a profit. The fundamental difference and the basic principle of the Islamic bank is the mutual distribution of both costs and risks, and income. While the basic principle in the traditional system is "money makes money". There is no speculation, and the profit depends on which sector the money is invested in and what share of the assets the depositor is entitled to claim.

Therefore, there are three main values in the Islamic bank system: the development of entrepreneurship and entrepreneurial skills; the development of trade and commerce; the ability to benefit the whole society.

In addition, there are some prohibitions in Islamic banking related to Sharia Law: usury or loans at interest; gambling earnings; speculation in the market; money of Islamic banks cannot be used for immoral purposes (drug trafficking, alcohol trade, etc.).

2. Integration of Islamic banking in the national banking sector: foreign experience

Over the past twenty years, the Islamic finance sector has experienced significant growth and today the volume of assets is about \$1.814 trillion (a six-fold increase over the past decade). Most transnational financial institutions participate in some form in Islamic finance as global banking, investment, consulting, accounting or information companies. Nowadays, Islamic financial institutions operate in at least 105 countries and more of them have already implemented (or are considering implementation of) legislation to provide a regulatory framework for the development of this type of financial industry.

In the Islamic world, Islamic financial institutions are major economic players. Five countries dominate in Islamic banking, namely Iran with \$345 billion of Islamic assets; followed by Saudi Arabia (\$258 billion), Malaysia (\$142 billion), Kuwait (\$128 billion) and the United Arab Emirates (\$112 billion). Except for Islamic countries, the industry is actively developing in many non-Muslim countries – mainly in Western Europe, the USA, Canada and Australia as a consumer segment (focused on local communities of Muslim immigrants) and corporate segment (focused primarily on attracting investment from oil-producing countries of the Persian Gulf). The greatest success in this direction was achieved by Great Britain: 22 Islamic banks with the assets value of \$19 billion (according to only six banks) and 34 Islamic investment funds with the assets value of \$300 million are operating on its territory; and 43 sukuk for a total amount of \$24 billion were

allocated on the London Stock Exchange. The experience of Great Britain shows that Islamic finance can be an attractive market segment for the existing banking sector, where from 22 Islamic banks 17 of them are Islamic windows of local traditional banks and only 5 of them are full-fledged Islamic banks founded by the investors from the Persian Gulf countries [13].

Today, London is the world's largest market for Islamic bonds. This is due to the global expansion of Islamic finance; global leadership positions of Great Britain in financial innovations, which has a strong potential of legal, accounting and financial engineering; excess liquidity in the Middle East; creation of regional offices in the Middle East and Asia, market research, improvement of the product line (Islamic windows); creation of a single financial regulator – Financial Services Authority, which replaced 11 regulatory bodies; elimination of double taxation on Islamic mortgages and expansion of tax benefits for Islamic mortgages to companies as well as individuals; reform of bond arrangements.

Federal Financial Supervisory Authority, the main Agency that regulates the banking sector, has issued a limited license to conduct banking activities of the Kuvейt Turk Participation Bank. The controlling stake in this bank belongs to Kuwait Finance House, one of the largest Islamic banks in terms of assets value. Among other shareholders – the Islamic Development Bank, which has a 9% stake in the Kuvейt Turk Participation Bank. Kuvейt Turk has a branch in the city of the same name, and the current issuance of the license, even if limited, actually means an increase in the status and powers of its German representative office.

It should be noted the so-called Islamic windows are also common in Germany, a number of financial institutions have them; in particular, Deutsche Bank, Hypo Real Estate Bank, Commerzbank and insurance companies such as Allianz and FWU AG, which distribute such Islamic financial products as real estate transactions, direct private investment, as well as transactions with Islamic securities [14].

For many years, the preconditions for the establishment of new financial instruments have been formed in France; this was the impetus for changes in the regulatory framework of the country. In 2007, Christine Lagarde, the Minister of Economy of France, asked the Parliament and the Treasury to evaluate and improve the infrastructure in order to attract Islamic finance. In the same year, Paris EUROPLACE, the organization, which is engaged in the development of the financial market in Paris, formed the Islamic Finance Committee to study the legal, financial and regulatory barriers in this field. Two years later a special working group was formed, which specialized in Sukuk. The group included lawyers, tax experts, consultants in the field of Sharia Law, as well as French banks, which dealt with Sukuk issues, in accordance with the French law.

In 2015, the first Islamic Bank NoorAssur started working in France. The above-mentioned organization began to provide not only banking but also insurance services pursuant to the Sharia Law.

The most active Islamic banks are located in those Western countries, where their activities have found their niche in the legislation. In the West, it becomes more fashionable to buy halal (i.e. allowed by the Sharia Law) financial products. In fact, 60% of funds from Islamic foundations are received from non-Islamic sources. Many specialists are already thinking about the practicability and possibility of using that part of Islamic law which regulates entrepreneurship, as well as determines the business methods based on religious norms by the modern Western economic and legal system.

As compared to the developed countries of Western Europe, the USA had a slightly different approach to attract Islamic finance. In this country, they looked through the stereotypes which accompanied the Islamic financial institutions, understanding the fact that Islamic finance is, first and foremost, a petrodollar. Since they saw the great benefit in it, they marked it as Ethical Investment, emphasizing that it is carried out in accordance with the principles of morality (even religious ones). Therefore, not only Muslims but also non-Muslims (55% of Islamic banks customer base) become clients of the Islamic financial system [19, p.73]. Today at least 15 banks which provide Islamic financial services are working in the USA. In the USA, where case law prevails, it is easier to apply Islamic business principles than in countries with more regulated legislation.

The first Islamic bank in the territory of CIS countries was Islamic Bank Al Hilal, established in 2010 in Kazakhstan. This financial institution is a subsidiary bank of Al Hilal Bank PJSC, which is one of the most progressive and developed Islamic state-owned banks in the United Arab Emirates. Al Hilal Bank PJSC has a high credit rating from Fitch Ratings and A2 from Moody's, which is an indicator of financial stability and reliability of the bank. In 2017, after seven years of successful work in the corporate sector, the bank began to provide Islamic banking products to individuals. Al Hilal Bank designed to actively contribute to the development and prosperity of the national economy by providing Islamic financial services to corporate clients and population. It should be noted that in March 2012, the government of the Republic of Kazakhstan approved the Roadmap for the development of Islamic finance until 2020 in order to further implementation of financial and banking services on the principles of Islam [20]. According to this document, the work on the integration of Islamic banking in the country should be carried out in the following areas:

1) improvement of legislation, in particular, development of additional recommendations for improvement of legislation on Islamic finance with the assistance of domestic and international consultants, consideration of the feasibility and necessity of establishing a separate legal framework for the functioning of Islamic non-banking and microfinance institutions (investment funds, leasing and mortgage companies), as well as companies with the status of Islamic professional participants in the securities market;

2) awareness-raising activities, in particular, the preparation and implementation of the media plan, consideration of the possibility of creating a special Internet portal dedicated to Islamic finance;

3) development of Islamic financial infrastructure, in particular, consideration of the possibility of establishing a Central Council for Islamic finance and establishing a regional Islamic financial center in Almaty city;

4) development of international cooperation, in particular, establishment of cooperation with international organizations including General Council of Islamic Banks and Financial Institutions, Accounting and Auditing Organization for Islamic Financial Institutions, International Islamic Financial Market, International Islamic Rating Agency, Islamic Financial Services Board, Islamic Solidarity Fund for Development, Islamic Liquidity Management Centre;

5) development of the public sector, in particular, consideration of the establishment of the Committee for Development of Islamic Finance under the National Bank of the Republic of Kazakhstan, implementation of the special intergovernmental program (twinning) for the study and experience exchange with the countries that have successfully implemented and develop the system of Islamic finance (Malaysia, Bahrain, UAE, Great Britain, USA, Luxembourg);

6) development of the Islamic financial services market, in particular, facilitating establishment of several Islamic banks and introduction of Islamic insurance;

7) scientific and educational work, in particular, the study of the methodology and experience of the Islamic financial industry and establishment of an educational and analytical center for the study of Islamic finance on the basis of Kazakh higher educational establishments, holding round tables with the involvement of scientists and practitioners;

8) cooperation with investors, in particular, conducting targeted negotiations and meetings with banks, funds, companies of the countries of South-East Asia and the Middle East in order to attract investments to Kazakhstan (financing of the investment project, conclusion of agreements), considering the possibility of carrying out organizational measures on the territory of the Republic of Kazakhstan (including Kazakhstan Islamic Financial Conference).

Almost all relevant ministries (Ministry of Foreign Affairs, Ministry of Industry and New Technologies, Ministry of Finance, Ministry of Economic Development and Trade, Ministry of Justice, Ministry of Education and Science, etc.), National Bank, National Economic Chamber, Association of Financiers of the Republic of Kazakhstan and a number of other institutions are involved in the implementation of the Roadmap for the development of Islamic finance until 2020.

Islamic banking is also being actively developed in the territory of Uzbekistan. In particular, in May 2018, the draft resolution of the President of Uzbekistan “On measures to establish the infrastructure of Islamic banking and finance in the Republic of Uzbekistan” [21] was published on the portal for the discussion of draft regulatory legal acts. In order to create alternative financing opportunities and meet the growing needs of the population and entrepreneurs, to expand the range of banking and financial services offered, to mobilize financial resources from the domestic and foreign markets on the basis of Islamic banking and finance principles, it was proposed, in particular, to form a Commission on the development and implementation of Islamic banking and finance principles. The working body of this Commission is the initiative group, which was established by the Ministry of Finance from among experts and specialists in the field of Islamic finance. The Commission will carry out activities to establish the necessary financial infrastructure in Uzbekistan, develop and submit regulatory legal acts on the implementation of Islamic banking and finance principles for approval by the law. The Commission is also responsible for coordinating the activities of ministries, agencies and other interested organizations in order to facilitate the prompt consideration, agreement and approval of draft relevant regulatory legal acts. In addition, the Commission will take measures to widely publicize the advantages and opportunities of using banking and financial services based on the principles of Islamic banking and finance among the population and business entities, as well as to explain their main differences from traditional banking services. On the completion of the working draft, the Commission is entitled to submit a draft decision of the President of the Republic of Uzbekistan on the establishment of the Islamic Development Bank of Uzbekistan in accordance with the established legislation.

It should be noted that in September 2018, the Islamic Development Bank (IDB) and Uzbekistan signed a partnership strategy for 2018 – 2021, which provides allocation of \$1.3 billion to the Central Asian country. In general, since 2003, in which Uzbekistan became a member of the IDB, the Bank has allocated \$1.9 billion for the implementation of various projects in the country [22]. It should be noted that Ukraine is also under review of the Islamic Development Bank. In 2014, the Secretary General of the Organization of Islamic Cooperation (OIC) expressed the idea of the necessity and possibility of Ukraine's inclusion. In case Ukraine joins the OIC as an associate member, the country is given an opportunity to use credit funds and various assistance programs through the Islamic Development Bank [23].

Ukraine desperately needs investment. Namely investment and not short-term credits. The Arab countries can help, they are ready to facilitate, if only the appropriate investment climate will be created in Ukraine. Following these positions, we agree with the conclusions of other researchers [24; 25; 26; 27] that it is not necessary to establish a radical Islamic Bank in our country. It should be an ordinary civil bank, which, first of all, is regulated by our legislation and operates under the rules of the Sharia Law.

The model of Islamic finance is necessary and promising for development in Ukraine. In particular, back in 2012, O. Suhoniako [28], the President of the Association of Ukrainian Banks noted that: "...nowadays the times demand looking for the equivalent of Islamic banking in the form of Orthodox or Christian banking. This idea is not considered in Ukraine. But it should be...". In the modern realities of social and economic development of our country, the Islamic banking can become an effective tool for the implementation of socially important projects. Islamic finance is based on the principles of trust, respect, risk sharing, compliance with commitments and fair distribution of profit. That is why Islamic financial institutions know exactly where their resources are directed, their quantity and for what purposes they are used.

Consequently, the risk to the investment project implementation is minimal. This financial mechanism allows to reduce the cost of attracted resources for the projects' implementation. In addition, Islamic banking institutions focus primarily on financing infrastructure projects and combating poverty. The development of not only the economic but also the social sector is extremely important for our country. The financing of public projects by traditional commercial banks is difficult without budgetary support. Instead, Islamic banking is based on spiritual and humanistic goals, which is manifested in the financing of education, medicine, the provision of charitable loans and the development of social infrastructure in general.

Given the existence of certain challenges in attracting the necessary financial resources in the European and American markets, as well as preparing necessary ground for the expansion of trade and economic relations with Muslim countries, the development of Islamic banking in Ukraine may become quite profitable for many reasons:

- the development of Islamic banking in Ukraine will contribute to the development of domestic financial institutions through the introduction of new banking products;
- the resources available in Muslim countries can be attracted to finance investment projects in Ukraine;
- the use of Islamic financial instruments and practical work with Islamic investments is the key to the future recovery of the Ukrainian banking system;
- participation of Islamic banks in the financial space of Ukraine will stimulate further development of business in the country through attracting investors from Muslim countries.

However, today there are several constraints to the development and implementation of Islamic banking in Ukraine:

- poor economic relations with potential investing countries from the East;
- lack of regulatory framework for the use of Islamic finance;
- lack of specialists in the field of Islamic economy;
- a very limited number of scientific researches of the Islamic banking instruments and the possibility of their adaptation to the needs of the national economy;
- biased attitude of the population associated with the threat of Islamic banks use for the terrorism financing.

From our point of view, the state should play a key role in overcoming these constraints in order to stimulate the arrival of Islamic financial products into the national market. It is necessary to approve the establishment of a special working group namely at the national level in order to develop a plan and measures for the possible use of Islamic financing instruments for the subjects of the domestic economy. The activity of such a group should focus on the following main areas such as the development of international cooperation, the development of the legal and regulatory framework, awareness-raising and scientific-educational activities. In this aspect, it is necessary to consolidate the efforts of the government, the National Bank of Ukraine, domestic economists and specialists in Islamic finance and law (the Sharia Law). After all, attracting the resources of Islamic banks will not only consolidate the stability of the domestic banking system, but also promote cooperation with the countries of the Middle East, increase funding levels for economic development programs of the country, priority sectors and entrepreneurship.

Conclusions.

Consequently, Islamic banks entered the financial markets and managed to occupy a niche in the global investment process. Islamic finance is based on the principles of trust, respect, risk sharing, compliance with the commitments and fair distribution of profit. This ensures the interest of Islamic banks in the final result of their activities, unlike conventional banks, which focus only on obtaining their own profit. An Islamic banking model has a specific set of properties contributing to formation of sustainable development of not only the banking market but also the financial market as a whole. Features of Islamic banking institutions activities become their advantages in comparison with traditional banking institutions. That is why Islamic banks have become active participants in the global financial market, despite the specific nature of their operations and difficulties of their adaptation to international practice. Islamic banking has spread not only in the developed countries of Western Europe, but also in Central Asia. The study of the process of Islamic banks activities in the financial markets of such countries as Great Britain, Germany, France, Kazakhstan and Uzbekistan allows us to identify two forms of their functioning: establishment of Islamic windows by banking institutions of these countries and direct entry of banks that originate from Islamic countries. The experience of the above-mentioned countries regarding the integration of Islamic banking into the national financial sector has shown, first of all, the need to develop an appropriate regulatory framework, to form an appropriate infrastructure, to conduct awareness-raising activities, to strengthen international cooperation with investor countries. The practical use of characteristics of the Islamic banking model is a promising direction in addressing the challenges of innovative banking products and services generation and modern banking modernization.

The possibility of applying the model of Islamic finance in Ukraine is not an easy task. In particular, it is necessary to develop an appropriate legislative and regulatory framework, to create an institutional environment, to increase the level of knowledge about the specific character of Islamic banking and to train practitioners in this field. According to these issues, the experience of the developed countries of Europe, as well as Kazakhstan and Uzbekistan on the process of implementation of Islamic banking in the national banking system is really useful. However, a solution to these problems requires a long time and considerable intellectual effort.

References:

1. Abdelsalam, O., Fethi, M.D., Matallin, J.C. & Tortosa-Ausina, E. (2014). On the comparative performance of socially responsible and Islamic mutual funds. *Journal of Economic Behavior and Organization*, 103, 108 – 128
2. Abduh, M. & Omar, M.A. (2012). Islamic banking and economic growth: The Indonesian experience. *International Journal of Islamic and Middle Eastern Finance and Management*, 5 (1), 35 – 47
3. Aggarwal, R.K. & Yousef, T. (2000). Islamic banks and investment financing. *Journal of Money, Credit and Banking*, 32 (1), 93 – 120
4. Ayachi Ammar, R., Ben Slama, M. & Saidane, D. (2013). Does the current practice of Islamic banks encourage growth? *Studies in Islamic Economics*, 6(1-2), 57 – 82
5. Beck, T., Demirguc-Kunt, A. & Merrouche, O. (2013). Islamic vs. conventional banking: Business model, efficiency, and stability. *Journal of Banking and Finance*, 37, 433 – 447
6. Mohieldin, M., Zamir, I., Ahmed, R. & Xiaochen, Fu (2012). The role of Islamic finance in enhancing financial inclusion in Organization of Islamic Cooperation (OIC) countries. *Islamic Economic Studies*, 20 (2), 55 – 120
7. Ongena, S. & Sendeniz-Yuncu, I. (2011). Which firms engage small, foreign, or state banks? And who goes Islamic? Evidence from Turkey. *Journal of Banking and Finance*, 35 (12), 3213 – 3224
8. Rashwan, M.H. (2012). How did listed Islamic and traditional banks perform: Pre and post 2008 financial crisis? *Journal of Applied Finance and Banking*, 2 (2), 149 – 175
9. Djennas, M. (2016). Business cycle volatility, growth and financial openness: Does Islamic finance make any difference? *Borsa Istanbul Review*, 16 (3), 121 – 145
10. Boukhatem, J. & Ben Moussa, F. (2019). The effect of Islamic banks on GDP growth: Some evidence from selected MENA countries. *Borsa Istanbul Review*, 18 (3), 231 – 247
11. Pshyk, B.I. (2013). Islamska finansova model: osoblyvosti, finansovi instrumenty, svitovi tendenciji [The Islamic financial model: features, financial instruments, global trends]. *Visnyk Universytetu bankivskoji spravy Natsionalnogo banku Ukrainy - Bulletin of the Banking university of the National Bank of Ukraine*, 2 (17), 20 – 24 [in Ukrainian]
12. Pantelejeva, N.M. (2012). Islamska bankivska sprava: sutnist, innovatsiji ta reguluvannia [Islamic banking: essence, innovation and regulation]. *Naukovyj visnyk: Finansy, banky, investyciji - Scientific Bulletin: Finances, Banks, Investments*, 3, 58 – 63 [in Ukrainian].
13. Mozgovyj, O.M., Subochev, O.V. & Jurkevych, O.M. (2017). Suchasnyj stan industriji islamskykh finansiv: statystyka jakisnogo rozvytku [Current state of Islamic finance industry: development data]. *Investyciji: praktyka ta dosvid - Investment: practice and experience*, 7, 8 – 14 [in Ukrainian].
14. Mykhajluta, S.L. & Chuyenko, N.A. (2015). Vyjavlennia faktoriv zabezpechennia stijkosti bankivskoji systemy na osnovi doslidjennia osoblyvostej islamskykh i jevropejskykh bankiv [An exposure of factors of providing of firmness of banking system is on basis of research of features of Islam and European banks]. *Visnyk Universytetu bankivskoji spravy Natsionalnogo banku Ukrainy - Bulletin of the Banking university of the National Bank of Ukraine*, 3, 12 – 17 [in Ukrainian].
15. Chugajev, O.A. & Cherednychenko, A.V. (2011). Islamskyj banking ta jogo finansovi instrumenty v koncepciji potencijnoji modeli finansovoji systemy [Islamic banking and its financial

instruments in the concept of potential financial system model]. *Ekonomichnyj chasopys – XXI – Economic Annals - XXI*, 3-4, 13 – 16 [in Ukrainian].

16. Stoika, V.S. (2015). Osoblyvosti funkcionuvannia islamskykh bankiv [The features of the functioning of Islamic banks]. In: Zbirnyk materialiv miznarodnoji naukovo-praktychnoji konferenciji “Devjati ekonomichni dyskusiji”, Lviv, Gruden 2015, pp. 64 – 67 [in Ukrainian].

17. Stoika, V.S., Sember, S.V. & Legeza, N.E. (2016). Islamski banky: osoblyvosti funkcionuvannia i rozvytku [Islamic banks: the specifics of their functioning and development]. *Ekonomika promyslovosti – Economy of Industry*, 1 (73), 5 – 16 [in Ukrainian].

18. Stoika, V.S. (2019). Integration of Islamic banking in the national banking sector: foreign experience. In: The 8th International Conference on Monitoring, Modeling & Management of Emergent Economy (M3E2 2019). Retrieved from: <https://www.shs-conferences.org>

19. Sidorov, V.I., Gaydey, N.S. & Sidorov M.V. (2014). Integracija islamskich bankov v strany byvshego SSSR, ES i SSHA [Integration of Islamic banks into the former USSR, the EU and the USA]. *Visnyk Kharkivskogo nacionalnogo universytetu im. V.N. Karazina - Bulletin of V. N. Karazin Kharkiv National University*, 1144, 69 – 74 [in Russian]

20. On measures to establish the infrastructure of Islamic banking and finance in the Republic of Uzbekistan (2017). Retrieved from: <https://www.mf.uz>.

21. On the approval of the Roadmap for the development of Islamic finance until 2020. (2012) Retrieved from: <http://www.istisna.kz/eng/img/Road-Map-IF-Development-20202.pdf>

22. The Islamic Development Bank and Uzbekistan signed an agreement for \$1.3 billion (2018). Retrieved from: <https://www.fergananews.com/news/32782>

23. Organizacija islamskogo spivrobitnyctva pidtrymuje terytorialnu cilisnist Ukrainy (2014) [The Organization of Islamic Cooperation upholds the territorial integrity of Ukraine] Retrieved from: <https://religions.unian.ua> [in Ukrainian].

24. Islamskij banking: perspektyvy razvitija (2015) [Islamic banking: prospects for development]. *Bankir – Banker*, 3 – 4 (53/54), 65 – 68 [in Russian]

25. Batorshyna, A. & Kuznietsova, I. (2019). Islamskyj banking: globalni trendy ta konkurentni perevagy [Islamic banking: global trends and competitive advantages] *Naukovyj visnyk Uzgorodskogo nacionalnogo universytetu - Scientific Bulletin of Uzhhgorod National University*, Vol. 23 (1), 10 – 15 [in Ukrainian].

26. Leliuk, Iu.M. (2017). Formuvannia antycyklichnogo potencialu vitchyznianoji finansovoji systemy: uroky islamskogo bankingu [The countercyclical potencial formation for the national financial system: lessons from the Islamic banking]. *Visnyk Odeskogo Nacionalnogo Universytetu. Serija Ekonomika- Odesa National University Herald. Series Economy*, 22, 8 – 11 [in Ukrainian].

27. Pavlenko, L.D. & Semenets, M.O. (2017). Stabilizacija bankivskoji systemy Ukrainy shlachom adaptaciji islamskoi modeli bankingu [Stabilization of Ukrainian banking system by adapting of the Islamic banking model]. *Efektivna ekonomika - Efficient economy*, 11. Retrieved from: <http://www.economy.nayka.com.ua/?op=1&z=5869> [in Ukrainian].

28. Suhoniako, O. (2012). Chas vymagaje shukaty analog islamskogo banking u formi pravoslavnogo chy khrystyjanskogo bankingu [Time requires looking for an analogue of Islamic banking in the form of Orthodox or Christian banking] Retrieved from: <http://glavred.info/archive/2012/04/23/084609-2.html>

Tatyana Pakhomova

*Doctor of Science in Public Administration, Professor, Odessa Regional Institute of Public Administration of the National Academy of Public Administration under the President of Ukraine.
orcid.org/0000-0001-9940-1418*

Anastasiia Rokotianska

*Ph.D. Student, Odessa Regional Institute of Public Administration of the National Academy of Public Administration under the President of Ukraine.
orcid.org/0000-0002-5831-8025*

PUBLIC-PRIVATE PARTNERSHIP RISK MANAGEMENT IN UKRAINE

Abstract. *In the context of resource constraints (above all budgetary levels at all levels), the public-private partnership itself offers an alternative in the form of attracting new sources of private funding and other potential (human resources, information, modern technologies, etc.) to create, modernize and develop vital infrastructure. preserving property rights in the public sector. Public-private partnership is a modern model of interaction between government and business. However, despite the existence of a legal basis for Ukraine, the real conditions for its effective implementation are being slowed down by the risks of initiation and implementation. public-private partnership projects. The types of risks affecting the development of public-private partnership in Ukraine are considered. The possibility of reducing the risks of public-private partnership projects is indicated. The importance of building institutional trust in the context of the initiation and implementation of public-private partnership projects has been determined. It is emphasized that institutional trust is a system-forming factor in the formation of a system for ensuring the implementation of public-private partnership projects in Ukraine. The conclusion is drawn about the necessity of building institutional trust and recommendations on the methods of its development in society. In the context of resource constraints (above all budgetary levels at all levels), the public-private partnership itself offers an alternative in the form of attracting new sources of private funding and other potential (human resources, information, modern technologies, etc.) to create, modernize and develop vital infrastructure. preserving property rights in the public sector. Public-private partnership is a model of interaction between government and business, which dramatically changes the usual "rules of the game" and allows to create projects with value for three parties simultaneously, opening up new opportunities: for the authorities - business competencies, accelerating the development of territories, community support; for business - a new nature of profit, a new scale, long-term; for society - a new level of quality of life.*

Introduction

In most modern countries, public-private partnerships are increasingly seen as one of the effective mechanisms for addressing infrastructure deficits, including, but not limited to, roads, railways, hospitals, schools and many other facilities that affect the lives of citizens. In Ukraine, as in many countries, there is an urgent need to rehabilitate existing infrastructure created decades ago. In addition, the challenge is to seek funding for brand new projects, especially those that address the problems of state functioning in the context of sustainable development. One approach to addressing these challenges is to use PPP.

Literature review

In the context of this analysis, it should be noted that within the framework of national methodological practice of identifying the term, public-private partnerships do not yet have a well-established tradition, which results in a multiplicity of contextually contradictory interpretations of the mechanisms of its implementation. Therefore, the role of each entity of the public-private partnership system is given its own functional content and is governed by their private interests, which leads to a functional "blur" and in some cases the de-context of the term.

Such a multi-context understanding of public-private partnership has led to some of its terminological «scattering», which has created some methodological confusion.

Therefore, it is natural to address the problems of developing partnerships between government and business in today's context. In recent decades, the problems of public-private partnership have attracted the attention of foreign and domestic scientists. Yes, the problem of identifying the concept of public-private partnership is raised by E. Savas (2000), who has singled out its meaning: a) any agreement in which the public and private sectors combine to produce and provide goods and services, b) complex, multilateral infrastructure projects; c) Formal cooperation between business, civil society and local authorities to develop territories and improve living conditions. J. Delmon (2009) examines theoretical approaches to the definition of public-private partnership and focuses on realizing the potential of the private-entrepreneurial initiative while maintaining the control functions of the state in socially significant sectors of the state's economy. , in which PPP is seen as a mechanism for establishing interaction between the state and business, which serves to achieve high rates of development of the state and the realization of its strategic goals. Theoretical approaches to substantiation of different types of partnership are developed by N. Didenko (2007), defines theoretical and methodological foundations of development and functioning of mechanisms of public administration in the system of social partnership; L. Gritsenko (2012), considers intersectoral social partnership (which may include public-private partnership) as a social resource of regional development; V. Alekseev (2012) examines partnership in the aspect of development of social dialogue between the authorities and the community; V. Varnavsky (2005), I. Zapatrina (2011), O. Piltiai (2011) explore the processes of formation and development of public-private partnership; V. Yakunin (2007) focuses on the principles of forming mechanisms of partnership in public administration; in the context of investment activity, public-private partnership is considered by E. Orlova (2010). In the context of the theoretical identification of the essence of public-private partnership I. Farley and others (2016), within which it means the instrument of establishing close interaction between the state and business, which serves to achieve high rates of development of the state, the realization of its strategic goals. In the study by H. Hodge (2016), public-private partnerships are explored as a way of supporting business in crisis situations and so on.

Research results and discussion

The widespread use of public-private partnerships on all continents and in many areas of activity traditionally practiced by the public authorities is not only limited by the budgetary resources available to fulfill the most complex tasks facing society today. This is caused not only by the need to use private funding for such purposes, but also by the need for the public sector to involve in the extremely complex projects the know - how and modern methods of work organization inherent in the private sector. However, a significant factor that slows down the implementation of public-private partnership projects in Ukraine is the existence of risks of such projects.

The model of public-private partnership is the basis for the development of most investment projects with the status of national in accordance with the National Development Priorities of Ukraine. With public-private partnerships, the government can get rid of investment problems by focusing on quality control. In turn, the private investor has the opportunity to optimize the ways of its financing to ensure the required level of quality of service. As the consumer becomes a customer, the private operator will need to improve the quality of the services provided.

Public-private partnerships open access to alternative private sources of capital, allowing important projects to be implemented that otherwise would not be possible.

The balance of risks of implementation is extremely important for the development of such a partnership. In this context, one of the benefits to public authorities of developing PPP projects is the transfer of risks to the private sector. But such a transfer, as well as the degree of willingness of the private sector to take on a considerable part of the risks, sometimes diminishes the effectiveness of partnership projects. First and foremost, creditor organizations may be denied funding for projects, in particular those of considerable social value, in the event that, according to preliminary estimates, the project may involve many risks.

In order to successfully launch a project, authorities must identify and calculate the major risks inherent in the implementation of projects related to services in a particular area. But as each project is known to be unique, there are no definite and consistent rules or risk-sharing models for all cases. Often, authorities can use less traditional and more flexible risk-sharing tools, which provides additional benefits for both parties. So the risks arising from the implementation of PPP projects may lead to the project not being completed.

Thus, according to the Ministry of Economic Development, Trade and Agriculture of Ukraine, as of 01.01.2020, 187 contracts have been concluded on the basis of public-private partnership, of which 52 contracts are implemented (34 - concession agreements, 16 - joint activity contracts, 2 - other contracts), 135 contracts are not implemented (4 contracts are expired, 18 contracts are terminated, 113 contracts are not executed) [11].

In total, over the period 1992–2017, 74 public-private partnership projects were implemented, in the first place in Ukraine in terms of the number of PPP projects - energy (46 projects), in the second place - communications (14 projects). Investments in these projects are the undisputed leader (79%). According to the World Bank, there have been only two seaport projects in the field of transport since 1992. According to the World Bank [20], despite the developed legal framework, public and non-profit institutions promoting public-private partnerships for infrastructure development have almost no experience of successful implementation of major public-private partnership projects compared to the leading countries.

Problems of public-private partnership can be presented as follows.

The first problem: the imperfection of the legislative system for the implementation of public-private partnership projects. Inconsistencies in issues such as the size and form of participation of each party to the partnership, the types and conditions of agreements with private investors, the distribution of risks and responsibilities slows down the process of developing and implementing public-private partnership projects. at the city level.

The second problem is the low level of competence of self-governing employees in the field of partnership. The low level of competence of municipal government employees in the field of partnership becomes a serious obstacle to the successful development and implementation of government-business partnership projects. This often manifests itself in the inability to properly formulate requirements for the project, to determine its quantitative and qualitative characteristics, to implement a competitive selection mechanism, to organize long-term regulation of public-private partnership projects, to form a budget regulation mechanism and so on. Because projects are different and very different from each other, it is necessary to make complex decisions on them and, therefore, it is necessary to have a high enough level of knowledge in the field of different types of partnerships.

To solve this problem, it is necessary, first, to promote the development of training programs for local government officials in the field of public-private partnership by introducing courses in the programs of the necessary disciplines; secondly, to promote the introduction of disciplines in the field of public-private partnership in the curricula of higher educational institutions; thirdly, to organize a section on the websites of specialized structures for the development of public-private partnership, which will contain information about the partnership, approved standard partnership agreements taking into account industry specifics, where public and municipal officials and private sector professionals can obtain information of interest. them, on various types of partnerships.

The third problem: insufficient number of project proposals implemented on the principles of public-private partnership at the city level. To solve the problem of shortage of proposals, it is important to expand the scope of public-private partnership projects at the city level and increase the motivation of participants in such projects by business structures. As a rule, in foreign countries the partnership is used in such areas as transport (roads, railways, airports, ports, pipeline transport) and social infrastructure (health, education, entertainment, tourism), housing and communal services, water supply, electricity, treatment water, gas supply, etc.), in other areas (prisons, defense, military facilities). The leader is the transport infrastructure, followed by a small gap in social infrastructure. The problem of insufficient awareness of business structures about possible models of partnerships and ways to optimize them deserves special attention.

The fourth problem: the high level of risks and the difficulty of attracting large financial resources by private partners on terms that allow to successfully finance long-term investment projects in infrastructure development. The difficulty is that not every investor is able to invest their financial resources in a long-term project with a high degree of risk. In the absence of adequate funding, projects may be at risk of non-completion, which is certainly unattractive to investors.

The fifth problem: the lack of specialized organizational structures for managing a set of partnerships. Currently in Ukraine, various structural subdivisions of city council executive bodies try to deal with various partnership problems, the actions of which are often uncoordinated, which is the reason for the lack of a systematic policy in the field of partnership development at the city level. The great organizational dispersion indicates the imperfection of management in the field of partnerships.

The sixth problem: the negative impact of the global financial crisis on the development of public partnership. The economic crisis may have a negative impact on the economic and financial performance of countries, as well as significantly change the perception of investors not only in Ukraine but also around the world about the attractiveness of various partnership projects.

The result of the economic crisis may be a decline in living standards and a decrease in real gross domestic product, respectively, public-private partnership projects, mainly projects with long implementation and payback, are largely affected by the crisis.

The fulfillment of its mission by local governments depends to a large extent on whether the private sector assumes the responsibility for performing, in particular, such functions as ensuring the functioning and maintenance of infrastructure. Public-private partnership also means not only attracting the private sector to finance investment projects on the basis of revenues generated from the operation of infrastructure, but also attracting the knowledge and experience of private sector management to implement and operate projects in the most efficient way during the contractual term.

Risk is a quantitative measure of the danger inherent in a particular activity. This is a certain event that can influence the progress of the project. PPP project risk and its assessment (characteristics) should be understood as the process of assessing the probability of its occurrence of the risk and the level of its possible consequences for the implementation of the PPP project, or have adverse consequences for the benefits of the partnership. The overall goal of the risk management process is to ensure the effectiveness of the PPP project by reducing the likelihood of risks or reducing the negative impact of their consequences to an acceptable level. The content of this process consists of functions that are separate activities of the PPP parties in the overall cycle of risk management. Therefore, an important factor in risk management is the system of techniques for performing individual operations, which are generalized in the risk assessment algorithm. The risks arising from the implementation of public-private partnership projects can be divided into the following groups, namely: technical risks; risks of default; financial risks; demand risks; political and legislative risks; environmental risks; social risks.

Given the importance of balanced risk sharing between partners in a public-private partnership project, it is important to have a clear understanding of the importance of different types of risks.

Technical risks include risks associated with the development of project documentation, the delay in the implementation of the project on time, etc.

The terms of the public-private partnership stipulate that the unfinished project is of limited value. A public-private partnership project enables the public sector partner to distribute the risk of an unfinished project in the most efficient way known as unilateral risk sharing. This means that all risks associated with the design, implementation, installation of equipment, project implementation, maintenance, maintenance and reconstruction are the responsibility of the private partner and are managed by him.

The components of the risk of project delay are the following: non-compliance with the requirements for the required quality of project work; unsatisfactory characteristics of technologies and lack of equipment and materials, restrictions on imports, pricing, financing and administrative costs; unforeseen events; the need to attract foreign specialists and import materials / equipment; visas and permits for such imports, as well as the corresponding restrictions imposed by national labor law; availability of infrastructure, such as water supply, sewerage, electricity, as well as its accessibility (road, rail, sea and air); a work completion plan that includes adapting building technologies to the climate, the time it takes to get approvals, coordinating subcontractors, etc.).

In order for the project to have a sufficient level of profitability for debt service and income generation, the level of products or services provided must meet the established quality requirements. Default risk is the likelihood of an event where the object created fails to provide the agreed quality services within the prescribed timeframes.

The occurrence of such risk may be due to the following reasons: mistakes in calculations when designing the object; use of inappropriate technologies; improper operation of the facility; inadequate quality of materials and raw materials used.

Financial risk includes, first and foremost, the reliability of the sources of funding involved in the implementation of the project, as well as the constraints that arise both at the time of financial closure of the agreement and throughout the project cycle. This risk can increase the cost of the project and have a key impact on the financial viability of the project.

In general, PPP projects are vulnerable to the following factors: term of loan repayment, as well as possibility of refinancing of short-term loans; the possibility not to pay interest during the grace period (adding them to the principal amount of debt) sufficient to solve the problem of income shortages during the construction period; interest rates: it is more appropriate to attract fixed rate loans in the context of project financing, given the fixed nature of the revenue stream; currency fluctuations. Most of the financing risk is managed by the private operator, together with the lenders.

Demand risks imply the risk that services / products produced by the infrastructure will not be in demand as planned.

Estimated demand level calculations may not be achievable: less motorists may use the toll road than expected, or the energy produced by the power plant, or heat, will be consumed in smaller volumes. This may be due, for example, to a decrease in the level of demand, the inability of consumers to pay for these services in the volume offered by the manufacturer, as well as a negative attitude of consumers and / or rejection of the product or service.

Forecasts of future demand, pricing and industry regulation in the country where the PPP project is being implemented will play a decisive role for private investors considering the project's profitability prospects.

For example, investors can: review the demand structure for the project's future products / services in the context of the extent to which the private participant company can take on the project risk and can influence demand in the future; to study demand forecasts and information on whether consumers in the past were prepared to pay certain tariffs and how timely they were doing so; to analyze the prospects for economic growth, demographic changes, current tariffs and forecasts of consumers' attitude towards paying higher tariffs; examine how cost-effective tariffs are to cover project costs. The assessment of demand depends on the macroeconomic cycle and microeconomic conditions, which reflect fluctuations in demand and are often caused by economic crises. These risks are borne by the private partner and partly by the government, because the decline in demand may be associated with higher fuel prices, lower purchasing power, and in this case the private partner cannot influence the situation. As a rule, the public partner provides state guarantees to cover unexpected expenses.

As a rule, the private operator provides better quality infrastructure services, and so a public sector partner may require that the private investor bear most of the demand risk in order to stimulate the private operator to introduce innovative technologies and improve the quality of service delivery to consumers.

The political risk group includes the following components: changes to laws or other regulations, in particular, the risk of discriminatory changes to the legislation (namely, changes related to a particular industry, private financing of state projects, etc.), as well as changes in technical parameters that necessitate obtaining permits, approvals and licenses; expropriation - international law provides that a sovereign state has the right to confiscate property within its territory for public purposes, but the owner must be compensated; introduction of regulations that are contrary to commercial agreements reached in the framework of public-private partnership; access to justice (corruption) by the private partner company, in particular, the ability to achieve obligations by the state or local self-government; instability of the political situation in the country and in its individual regions, military action.

Environmental risks relate, first and foremost, to the implementation of infrastructure projects. They are related to the possibility of occurrence of natural ecological crisis phenomena, etc. Environmental risks are associated with the costs of eliminating the negative consequences of activities. Such costs lead to a decrease in profits, and hence - the profitability of the project for its owners. The result is harm to human health and the environment. Social risks are caused by the deterioration of the social development of a country or an individual region during the implementation of public-private partnership projects. The success of any project is always based on the principle of effective risk-sharing between each component of the project among the participants in the partnership, which is in the field of profitability (for the private sector) and efficiency (for public office). The very meaning of distribution is that the parties take on risks that they can better manage and thus minimize costs while increasing productivity. Usually, most of the risks are related to private partners. External risks are assigned to public authorities: force majeure, legal and political risks.

A possible criterion for justifying the risk allocation of a PPP project may be a factor such as an analysis of the needs that will be met through the project results. Their definition and analysis allows to build a model of distribution of financial flows in the implementation of PPP projects, on the basis of which it will be possible to proceed to the financial justification of the project: assessment of efficiency, sources and conditions of external financing, payment mechanisms, independent expertise and risk matrix. That is why at the initial stage of PPP projects it is necessary to identify the list and sources of risks associated with each aspect of the project and to distribute them between the public and private sectors or to agree on joint responsibility for certain categories of risks.

The basis of successful risk allocation is the proper assessment and pricing of each risk. It is extremely important that all parties agree on the assessment of each risk, and that the party who assumes a particular risk is provided with the means to control the main factors that shape this risk.

The distribution of risks between the parties is based on the proposals of the body that analyzes the effectiveness of PPP and identify possible risks associated with its implementation, taking into account the proposals of the private partner and finally determined in the contract concluded within the PPP. The distribution of risks takes into account the fact that:

- part of the commercial risks is borne by the private partner;
- part of the political risks is borne by the public partner.

The distribution of risks between the parties to the PPP is based on the following principles:

- fair distribution of risks associated with the implementation of the agreement concluded under the PPP between the public and private partner;
- transfer of part of the risks to the private partner in the process of PPP implementation;
- taking into account the peculiarities of the PPP project;
- taking into account the ability of the partnership to assess and control risks, take timely measures to manage them, take effective measures to minimize risks, diversify risks and reduce risks at lower costs;
- taking into account the financial position of the party at risk, as well as its ability to be responsible for the consequences of such risk.

The main purpose of such a distribution should be to transfer risks to a partner who can manage them more effectively.

To determine the form and level of influence of the public authority system on the PPP process, it makes sense to apply a structural and functional approach, which focuses not only on the organizational basis of PPP construction, but also on its dynamics, its actual application.

It should also be noted that, in our opinion, the system-forming factor in creating a system for ensuring the implementation of public-private partnership projects is trust in public authorities (institutional trust). The problem of trust is one of the key issues in the modern Ukrainian society and in the initiation and implementation of public-private partnership projects. It should be emphasized that in order to increase the socio-economic level and the well-being of the population and the implementation of the public-private partnership development strategy in Ukraine, it is necessary to maintain trusting relationships at all levels of the social organization - from interpersonal contacts to the attitude of citizens to the state, social and political institutions and authorities. The results of the study of such complex multifactorial phenomenon as “institutional trust” in the context of revealing the role and place, functions, mechanisms of trust development between different elements of Ukrainian society can be used in the process of public-private partnership.

The policy of implementation of public-private partnership projects cannot be fully implemented and sufficiently effective if the public lacks public confidence in public authorities and vice versa. General theoretical approaches to the study of trust as a multidimensional phenomenon, specified in the theory of social capital, rational choice, social exchange, social networks, which were reflected in the works of K. Newton (2007), F. Fukuyama (1995), P. Sztompka (2012) etc. However, despite the importance of building trust in various spheres of social development, there remain a number of challenges for scholars related to the systematic development of trust in the context of achieving the goals of public-private partnership.

In political marketing, «production», «building trust» is a mandatory postulate: a political transaction is considered effective if during its course it is possible to create long-term, mutually beneficial relations between the parties to the exchange. It can be argued that: trust in public administration is the degree of recognition by society of activities, decisions of public authorities and individual officials on the basis of rational, targeted, legal, socio-economic factors, based on the expectations of society from the relevant institutions of government of certain actions and can have a personalized character. As a socio-political phenomenon in public administration, it reflects the ability of public institutions to represent the values of society and has a dynamic character, denoted by the term «credit of trust», which includes expectations of the most positive actions and decisions from the government in the future (Fedoriv T, 2013). In the context of the initiation and implementation of public-private partnership projects in Ukraine, it can be concluded that minimizing the credibility of government institutions is one of the greatest risks.

In a certain way, the risks of public-private partnership can be minimized by civic participation, that is, a process in which citizens get the opportunity to influence decisions of public authorities, and directly - the ability to monitor their implementation if these decisions directly or indirectly affect the interests of citizens.

This type of participation is different from the traditional participation of citizens in the electoral process and is implemented using other methods. Citizens, getting the opportunity to participate in regulatory processes at their early stages, are even more actively involved in the processes of direct implementation.

Conclusions

Reducing the risks of developing a public-private partnership system helps to create an environment conducive to public-private partnership in Ukraine through the following tasks:

Increasing institutional confidence, implying introduction of new communication technologies that would strengthen confidence in government bodies and other socio-political organizations; formation of new types of social and political communication in society; the development of social dialogue, which results in the legitimation of power itself.

Improve legislation to create a legal environment consisting of laws and by-laws facilitating PPP implementation.

Implementation of public-private partnership pilot projects in key sectors by assisting pilot cities at all stages of project preparation: from conception to presentation of pilot projects on the market through transparent and competitive competition. The practical experience gained will serve to further improve the environment and processes for the use of public-private partnership projects in Ukraine.

Development of educational programs that inform the population about the benefits of participation of private companies in the provision of social, communal and infrastructural services. For the proper implementation of PPP projects, it is important to consider other important issues that may mitigate or increase risks.

Thus, reducing the risks of public-private partnerships initiation and implementation ensures that the quality of the provision of services to the public is within the competence of the state or; creates prerequisites for the implementation of major infrastructure projects that could not be implemented in the future, as well as for the implementation and development of the most profitable objects of state ownership, implementation of modern principles of governance in public authorities and local governments.

Crises accelerate the need to improve the existing system of economic management, in connection with which the authorities have to look for new methods, ways to adjust the existing mechanism for managing public-private partnership projects, which requires time and reduces the efficiency of management.

There are threats that the hasty transfer of assets to a private partner without careful public sector research could lead to the risk of losing vital services to the general public. The principle of caution should be followed when entering a project, because without prior study of the situation, what has already been done and what needs to be done, there is a possibility of repeating mistakes that were made in other countries. Improper public-private partnerships in many countries have resulted in lengthy negotiations between public and private partners, delayed decision-making, a lack of flexibility in risk-sharing, and, finally, the cancellation of projects due to cost inefficiencies.

Institutional certainty is the most important factor for success, as private partners seek to avoid projects that may pose unforeseen risks. Today, there are the following types of these institutions: "formal institutions", which contain general legislation governing rules and regulations, policy decisions, and structures where citizens can express their views, as well as such "institutions for realizing the opportunities" of partnership, as partnership development governance bodies and "informal institutions", such as forums and platforms where the public and private sectors can jointly discuss and reduce misunderstandings, as well as resolve contentious issues that arise when discussing specific projects.

References

1. Alexeyev, V. (2012) *Society and the State: Managerial Relationships*. Chernivtsi: Technology Press: 344.
2. Business risks in private-public partnership. National report: <http://www.google.com/url?sa>
3. Gritsenko, L. (2012) *Modern Forms of Interaction between the State and Business in the System of Public-Private Partnerships. Problems and prospects of development of the banking system of Ukraine*: (35): 164-177.
4. Delmon, J. (Ed.). (2009). *Private Sector Investment in Infrastructure. Project Finance, PPP Projects and Risk*.
5. Didenko, N. (2007) *Development of mechanisms of public administration and local self-government in the formation of intersectoral social partnership in the region. The theory and practice of public administration: Harinad Master*. 1 No. 16: 184-192.
6. European Public-Private Partnership Association C.R.E.A.M Europe PPP Alliance. *Concept of a Business Model for the Support of PPP Project*: <http://cream-europe.eu>
7. Fedoriv, T. (2013) *Trust as a Methodological Basis for Forming the Reputation of Public Authorities*. *Economy and State* No. 2 :127 – 130: <http://www.economy.in.ua>
8. Ferlie, E., Ashburner, L., Fitzgerald, L., Pettigrew, A. (2016) *The New Public Management in Action*. Oxford: Oxford University Press: 239-240.
9. Fukuyama, F. (1995) *Trust: the social virtues and the creation of prosperity*. New York.
10. Hodge, G., Greve, C. (2005) *The Challenge of Public-Private Partnerships: Learning from International Experience*. Cheltenham, UK: Edward Elgar: 357.
11. Ministry of Economic Development, Trade and Agriculture of Ukraine: <https://www.me.gov.ua>
12. Newton K. (2007) *Social and Political Trust in Established Democracies. Critical Citizens: Global Support for Democratic Governance*. Pippa Norris Ed. Oxford, UK.
13. *On the development of public-private partnerships as a mechanism for intensifying investment activity in Ukraine* (2016) National Institute for Strategic Studies.
14. Orlova, E. (2010) *The mechanism of investment interaction of business structures and local self-government. Monograph of the Soviets. - Vologda: ISEDT RAS*: 184.
15. Piltay., Oh. (2011) *Current Concepts and Approaches to Defining Public-Private Partnerships* *Economy. Management. Innovation*: http://nbuv.gov.ua/j-pdf/eui_2011_2_40.pdf.
16. *Public-Private Partnership in State Relations with International Organizations and Transnational Companies* (2015) NAS of Ukraine, Institute of Economics. and forecasting. Kyiv..
17. *Reference on the results of PPP implementation*: <http://www.me.gov.ua>
18. Savas, E. (2000) *Privatization and the New Public Management*. *Fordham Urban Law Journal* 28: 5 (8): 1730-1737.
19. Stompka, P. (2012) *Trust is the basis of the society*. Transl. from the Polish N.V. Morozova. M.: Logos. [in Russian].
20. *Ukraine-Private Infrastructure Projects*: <http://ppi.worldbank.org>
21. Yakunin, V. (2007) *Partnership in the mechanism of public administration*. *SOCIS*: 2: 58 - 68. [in Russian].
22. Zapatrina, I. (2011) *Development of state support for public-private partnerships in Ukraine*. *Economy and forecast*: 3: 9 - 24.
23. Varnavsky, V. (2005) *Public-Private Partnership: Forms, Projects, Risks*. M.

Nina Fedorova

PhD in Pedagogy, Senior Researcher,

Institute of Gifted Child of the National Academy of Pedagogical Sciences of Ukraine, Ukraine
orcid.org/0000-0003-4382-4686

Vasily Madzigon

Doctor of Pedagogical Sciences, Professor,

Full Member of the Academy of Pedagogical Sciences of Ukraine,

Chief Employee of the Department of Innovative Technologies,

Institute of Gifted Child of the National Academy of Pedagogical Sciences of Ukraine, Ukraine
orcid.org/0000-0003-0692-2500

Svitlana Merkulova

PhD in Pedagogy,

Associate Professor of English Philology and Translation Department of the Institute of Philology,

Kyiv Borys Grinchenko University,

Kyiv, Ukraine

orcid.org/0000-0002-3051-119X

STUDIES OF INNOVATIVE PEDAGOGICAL ACTIVITY OF A TEACHER

***Abstract.** Every period of society and education development is also defined by socio-political events and characterized by conditions that require changes in all spheres of life, as well as in pedagogy. Today's secondary education must meet the requirements of the times. To prepare the younger generation to be competitive in the labor market. These changes are based on the embodiment of a new, non-existing or existing as another dialectical form. At different times School reflected a certain era in the development of society. Thus, in the 80s of the twentieth century, teachers who used innovative technologies in their pedagogical activity began to be called innovative teachers. Such teachers were: A. Zakharenko, A. Solohub, A. Alfimov, M. Huzyk, O. Shcherbakov, P.A. Heval and many others. Teacher is the main figure in forming the future citizen of any country. Therefore, the authors of the article pay attention of the reader at the integrity portrait of teacher. He is the first in his professional activity to use innovative pedagogical technologies, which are revealed in the text of the article.*

Introduction

Teaching is the most ancient profession of humankind. This noble profession was practiced before the appearance of writing and schools as educational institutions. School reflected a certain era at different times in the development of society and the role of teacher was so important that scientists were especially interested in teacher's pedagogical activity. The Ukrainian Pedagogical Encyclopedic Dictionary by S. Honcharenko defines *pedagogical activity* as a field of teacher's professional occupation in training, education and development of students. Besides definition, it uncovers main components of teacher's pedagogical activity. The first component is Constructive and associated with the selection and composition of content, design and implementation of the educational process. The second is Managerial, containing its own educational transfer activities as well as guidance on students' educational activities. Next is Communicative, comprising the area of teacher-student relationships. Another is Gnostic, which is containing a study of intellectual, psycho-motor and emotional abilities of students by the teacher; teacher's revision of content, forms, methods and means of educational process realization; merits and demerits of the own personality and some actions with the purpose of its perfection [1].

Returning to the timeline, we must admit that every period of the development of society and education is also defined by socio-political events and characterized by conditions that require changes in all spheres of life, as well as in pedagogy. These changes are based on the embodiment of a new, non-existing or existing as another dialectical form. The unity and conflict of opposites compel society to modernize, renew and change the course of processes. We call this new "novelty" or "innovation" that is essential in every historical stage of our country development.

1. Innovation as a subject of scientific research.

In the mid-1980s, journalists were the first, and after them professionals of the pedagogical sector started using the term "innovation" actively in pedagogical discourse to refer the processes of restructuring national pedagogical system that had begun. Innovations are a stimulating function of social development, training and education, and they have a long-term strategic character. To identify the notions "*innovation*" and "*innovative activity*" we referred to the Glossary of Terms on Innovation Management, which provides the following definition: "*innovation*" is an invention in engineering, technology, work organization and management based on the use of science achievements and best practices, as well as the use of these inventions in a variety of areas and spheres of activity "or"... it is a complex process of creating, distributing and applying new means (novelties, inventions) in the field of engineering, technology, pedagogy and research", and "*innovative educational activity* is one of the forms of investment activity that provides the development, distributing and application of innovations in the education system with the purpose to improve or update. It is characterized by the following processes: identification of innovative initiative, creation of educational innovation, approbation, dissemination, assimilation, preservation and expertise"[3].

Remarkable Ukrainian teachers and scientists study the problems of pedagogical innovation. Among them: V. Kremin, I. Ziazun, I. Bekh, V. Madzigon, O. Savchenko, A. Furman, O. Kozlova, N. Fedorova, L. Burkova, G. Yelnikova, A. Solohub, I. Kozlovska, K.V. Makohon, S. Podmazin and others. The process of innovation development is creative and meets the terms of search for something new and original, but we state that not always it is the appearance of some inventions, so this process is incorrectly called an innovation. It can be called innovative when it comes to mastering and distributing innovations into pedagogical practice. Thus, pedagogical innovation is not the idea itself, but rather its design [2]. Can we meet a teacher whose professional teaching activity is called innovative? Of course, we can. *Innovative teachers*, who developed and implemented new learning principles and technologies in their professional activities, appeared in the 80's of the twentieth century. These innovative teachers are: A.A. Zakharenko (School Director from Sakhnivka Village, Korsun-Shevchenkivskyi district, Cherkasy region); A.I. Solohub (Creator and Director of Dolhintsivskyi Lyceum, Kryvyi Rih City); A. Alfimov (Director of the Lyceum, Donetsk city); M.P. Huzyk (Creator and Director of a School Complex, Odessa city); O. Shcherbakov (Director of "School – Kindergarten", Kharkov city; it is high school today); P.A. Heval (Director of Primary Educational Complex, Khmelnytsky city) and many others.

Today, there are many talks about efficiency and rationality of pedagogical activity, about its techniques and technology, about economic education, computerization of learning, etc. It is necessary to define several stages as parts of significant component of the innovative organization of pedagogical teams activities: 1) key point of innovative understanding of education is term "*investment program*" (project, plan) and *investments* (education, in general, is an investment in a person's preliminary opportunities); 2) *choice* (made by students, parents, society) of one or another orientation or directed training [2].

Universal character of innovations require study of innovation subjects from one person to society as a whole, from the person who creates innovations in their own activities, to their social reproduction as a whole. Person as a subject of innovation is considered as one of substantial aspects of research. Personality is always balancing between the urge to innovate, change and improve one's own activities, approaches and relationships, etc. from one side, and the fear of innovations with their destructive consequences from the other.

Innovations are essentially different in scale and focus on the person in different social processes. According to the experience, subject, endowed with the ability to predict events more or less, is in dependence of the above-mentioned prediction that transforms his internal state of uncertainty from expecting to upcoming events and after changes the state to maturity before any coming accidents. Innovation occurs as a result of human research activity in a particular area, which has become problematic and causes the internal tension of the need for exceptional thing, novelty, challenges to think and act, respond to pitfalls with their own innovations. These phenomena can occur not only in the environment but also in the inner world of a person, in sphere of personal values and needs.

Current changes penetrated all spheres of social activity and life, as well as in education. Talking about the global crisis in education, we agree that innovations are considered as an effective means of overcoming this crisis. In addition, teacher is the predominant executive of educational improvements and changes in secondary educational institutions. Teacher's activity, accompanied by the use of pedagogical innovative technologies, is an innovative activity as a constituent and a component of the transforming society as a whole. Prominent teacher and writer, founder of scientific methods of teaching, K. Ushynskiy argued that it is not possible to adopt the experience, only the idea can be appropriated. M. Pyrohov (physician, educator and scientist) accurately stated that predominant spirit of science causes great things happen with small donates.

2. Innovative processes in pedagogical activity: current situation

The concept of "pedagogical innovation" includes changes aimed at improving and development of training and education of the younger generation. School is always focused on changes, but only today. These changes become a mass phenomenon. Today, teacher in our society exceeded the role defined for him 10–15 years ago. He is no longer that gifted teacher and, at the same time, he could be fairly criticized as programs performer.

Contemporary socio-pedagogical priorities, new pedagogical paradigms approval, exaggeration of contradictions between vocational training and individual-creative character of pedagogical activity, great scale of practical tasks, solving by teacher with insufficient level of his professional competence is today's reality. Nevertheless, we observe new teacher with the ability to respond promptly to any changes in society and education system that require a significant increase in his professionalism, development of his creative potential, personal and professional qualities in accordance with the level of the development of science, culture, economy, social sphere, production and general culture. The prerequisites for the above mentioned teacher training is his desire for constant personal development and professional growth.

Education is a fundamental component of society, and a teacher is a member of its structure, who, like other people, is short of the immunity to innovations, but, at the same time, it is not devoid of traditions and conservatism. Sociologists believe that person is inclined to changes by nature. Others believe that person is more oriented to the existing in reality and less – to the unknown and new, until it is tested. In fact, person is adaptive to new things and changes. Therefore, traditions and innovations coexist in society as if it were in association.

Innovative mechanisms of education development bring to the society as follows: establishing creative atmosphere in educational institutions and encouraging an interest in the use of innovations; creating socio-cultural and substantial (economic) conditions for acceptance and functioning of different innovations; initiating search engine educational systems and mechanisms, and their comprehensive support; integration of perspective innovations and productive projects into real-life educational systems and implementation of accumulated innovations in the mode of search and experimental educational systems.

Innovative processes can be distinguished into separate cycles of development.

The first cycle is Establishment. It is characterized by reflection and reassessment of personal experience, search for new ideas, new understanding of education values occurrence and dissemination in pedagogical, parental and managerial environment, creation of primary projects and modeling of experimental systems.

The second cycle is Development with goal-oriented simulation of educational projects, approval and support of new thinking and experience values, dissemination of new cultural environments of education, creation of new societies focused on collaborative development of education.

The third cycle is Transformation. It includes regulatory support for innovative forms of pedagogical activity, their widespread and applying in different forms. Efficient changes in the educational space, identifying the willingness of teachers and administrative leaders to participate in the implementation of novelties and, as a result, the introduction of a new cycle with understanding and reassess of the previous experience.

Today, most of pedagogical teams work in innovative mode. Main directions of these processes evolution are: developing new goals for education content; explore forms, methods and means of leading educational activity; outlining ways and defining conditions for providing person-centered, individualized and differentiated approaches to students.

We consider teacher requires the integration of studies in this direction with promising creation of effective pedagogical innovative technologies of training and education. Besides, designing effective education technologies in different directions (moral, mental, labor, artistic, etc.) will give new perspectives in pedagogical activity. Nowadays, teacher has freedom of choice in his professional activity. Moreover, he has an open road to creativity. At the same time, most of teachers do not have scientific and practical basis of pedagogical creativity, and are not able to choose necessary instruments, forms, methods and means from the diversity of educational services in current situation. In addition, teachers are not familiar with technology of preparation (designing, creating) educational material and planning educational process.

Today, there are no questions about teachers' adaptation to new forms of training. However, it is necessary to create a situation for teachers to reorganize the established ways of educational and cognitive activity. Certification of teaching staff became an effective motivation in this situation. The introduction of certification encourages teachers to look for innovative technologies that contribute to their professional development and pedagogical skills. Teachers' pedagogical skills require their creative attitude to professional activity.

Creativity does not exist without the use of innovative educational technologies by teachers of all kinds of educational institutions, particularly, secondary education institutions. Teacher's creativity should be realized in the process of their professional pedagogical activity. Today, creativity is expressed through the connection of science and practice. The above said is provided by the National Doctrine of Education Development in Ukraine.

Historically, the definition "technology" appeared in connection with technological progress. According to the vocabulary, interpretation (techne – art, craft, science + logos – concept, doctrine) technology is systematic knowledge about the ways of processing materials. Technology also involves the art of accomplishing a task using a process that results in personalizing. Technology in the procedural sense answers the question: "How to accomplish (what data and by what means)?"

The term "pedagogical technology" was first mentioned in the works on Pedology (children study) by I. Pavlov, V. Bekhteriev, A. Ukhtomsky and S. Shatsky in the 1920s. In the late 70's – early 80's of the twentieth century terms "teaching technology" and "pedagogical technology" became more commonly understood as a system of means and methods of organization and management of the educational process due to the development of technology, and then computerization of study abroad [4]. Individual proficiency prevails until the technology is created. Nevertheless, eventually it was replaced by "collective proficiency" with concentrated expression of *technology*. Let's compare proficiency with technology (see Table. 1) [7].

Table 1. Comparison of proficiency and technology

No	Individual proficiency	No	Common technology
1.	The process is accomplished by the worker from the start to finish.	1.	The process is divided into parts, each worker accomplishes a part of the work.
2.	Knowledge of system, as well as all complexities of the process is required	2.	Knowledge of the part of process accomplished by the worker is required.
3.	It is necessary to accomplish by yourself.	3.	Introduced "finished" completions, which excluded the need to accomplish the process alone.
4.	The process is durable.	4.	The process is much faster.
5.	Products are of high quality.	5.	Products are also of high quality.
6.	Intuition, feeling and experience are the basis.	6.	Scientific calculations and knowledge are the basis.
7.	Products are limited by the manufacturer's capabilities.	7.	Products are not limited by the capabilities of individual manufacturers, mass production is possible.

So, *pedagogical technology* is a systematic method of creating, applying and defining the process of teaching and assimilation of knowledge taking into account technical and human resources, their interaction, which intends to optimize the forms of education. Also, it is a way of organization, objective vision of materials, people, institutions, models and systems like "*man vs machine*". In addition, it is a test of the problem effectiveness (UNESCO).

The volume of information today is significant and fleeting. Personality should renew the accumulation of knowledge and improve general cultural level. At the same time, secondary education institution should develop steady interest of students in learning the new; provide them with mechanisms for gaining new knowledge independently.

Today, secondary education operates with innovative technology designated as "*interactive*" methods. Interactivity (from English – interaction) means organized cognitive activity based on creative potential of students in terms of a social orientation. Interactive learning aims at creating feedback [4]. As a form of educational process organization, interactive methods have a specific purpose in creating comfortable conditions for students to obtain educational services, perform better academically and use their intellectual ability. All students appreciate creativity that is typical to interactive educational methods.

They can discover something new that will raise their interest in gaining knowledge, increase motivation and, consequently, achieve educational goals. However, the use of interactive technologies has pros and cons (see Table. 2).

Thus, interactive educational technologies have more powerful advantages, contribute to the activation of cognitive activity and development of thinking. More over, they teach students how to communicate constructively, attempting compromises; form the ability to listen and to hear the interlocutor, work in a team to challenge the future. Therefore, interactive educational technologies bring new stream to traditional learning.

Table 2. Interactive pedagogical technologies: pros and cons

No	Pros	Corns
1.	Student performs better academically, encouraged by the educational process.	Even interactive educational technologies do not empower student to overcome objection to participate in educational process.
2.	Students are involved in the process of cognition, they are able to understand and reflect with knowledge and thoughts.	For some students, interactive technologies violate the traditional concept of receiving educational services that leads to destruction of their ideas and generating internal discomfort.
3.	There is helpful and pleasant atmosphere, which allows learning, developing cognitive activities, and moving to a higher level of cooperation.	During the discussion, someone's opinion prevails not considering the opinions of others, especially if the speaker is a leader in class.
4.	Interactive technologies eliminate the benefits of thoughts.	For some students, learning with a team using an interactive technology is a tool not to do the assignments.
5.	Students learn: think critically; solve complex problems based on the analysis of circumstances relevant information; evaluate alternative thoughts, make decisions; participate discussions communicate to other students.	If the teacher does not apply interactive technologies, the educational process won't be controlled.
6.	Interactive technologies develop communication skills and skills that help making contacts between students, provide realization of educational goal, teach to work in a team; listen to opinions of classmates.	It is necessary to remember that interactive educational technologies are those to provide the main idea of educational process - gaining knowledge on a specific issue of educational information.
7.	Interactive technologies take off nervous tension of students, provide the opportunity to change the form of activity and switch focus to the main questions of the lesson theme	

A model of interactive educational service is impossible without active position of all participants at each stage of the educational process. By this technology, teacher ceases to be central figure and the carrier of knowledge. Teacher identifies questions, formulates tasks, acts as a consultant, allocates time limits, etc. Student takes a role of teacher's colleague who possesses independent thinking and acts as a source of knowledge [4]. Role-playing games, training, brainstorming techniques, etc. are used to implement interactive method of obtaining educational services. The above mentioned techniques allow students to be acquainted with the complex aspects of social behaviour, to form a culture of reflective thinking, to learn the ways of overcoming difficult situations, to implement search procedures, etc. In addition, the process of providing educational services involves the use of discussions, cases, simulation and business games and more.

Teachers started applying widely interactive educational technologies with the appearance of IT and Internet. Current situation demonstrates that most employers claim their employees to have practical experience in using these technologies. This factor causes a significant transformation of educational processes.

However, the teacher must perform the qualities of creative personality and tolerance should be the main feature of pedagogical activity. First, it involves subject-subject relations. Second, it provides a person-centred approach.

Tolerance in secondary education involves: cooperation, a spirit of partnership; willingness to accept other's opinion; respect of human dignity idea and the rights of others; accepting another personalities as they are; empathy; appreciate the right to be different; recognizing the equality of others; tolerance of others' thoughts, beliefs and behaviour; declining the dominance of harm and violence [9]. The teacher's tolerance can be considered with three aspects of his personality: 1) personality as a subject of educational process with tolerant qualities; 2) displaying tolerance in professional activity; 3) implementation of tolerance principles in pedagogical communication.

Tolerant teacher becomes an example for resemblance, assimilates and applies appropriate skills to communicate with students, arranges calm conflict resolution, stimulates creative approaches, respects the opinion of others and expresses clearly his own, provides constructive activity of the educational process. The difference between a tolerant and an intolerant teacher can be seen in Table 3 [6].

Table 3. Features of teacher tolerance

No	Tolerant teacher	Intolerant teacher
1.	Knows his own advantages and disadvantages	Notes more own advantages than disadvantages
2.	Critical to himself, he does not rush to blame others	Less critical, more often blames others for their own failures
3.	Substantial gap between "I-ideal" and "I-real"	"I-Perfect" and "I-Real" are practically the same
4.	Empathy is expressed sufficiently	Empathy is basically not expressed
5.	Teacher bears responsibility for what is happening	Trying to take responsibility for what is happening
6.	Recognizes the multidimensionality of the world, people, their positions and thoughts	The world is divided into black and white, people are good and bad
7.	The order is not of value to him and becomes secondary	Order is important to him in everything, especially significant social order
8.	Self-centred, seeks personal independence	Attempts to belong to public institutions
9.	Able to smile at himself, has a sense of humour	The sense of humour is poorly expressed
10.	Prefers a free democratic society	Prefers an authoritarian society with strong authority

Personally oriented approach in secondary education institutions means setting up: 1) conditions for participants of the educational process (students, teachers, managers); 2) effective (external) stimuli of social development; 3) introduction of modern pedagogical and psychological technologies of individual into the educational process, ensuring emotional comfort and social protection [4]. Secondary education institution implementing curricula faces organizational difficulties related to the heterogeneity of the contingent. Each student should have an individual "educational guide" that will allow to optimize educational process and efforts of the teaching staff.

Let's pay attention to the main differences between person-centred educational services and traditional ones, as shown in Table 4. Technology of tolerant communication is based on the ability of teacher to understand student mental state based on external expression, to adjust to it and announce as much positive as possible. Tolerant teacher behaviour algorithm requires: situation analysis; prompt search for possible behaviours; choice of the optimal method; organization of tolerant interaction [6, 7].

Educational discussion is also important among innovative learning technologies. Main feature of educational discussion is deliberate and well-organized exchange of ideas, thoughts, and judgments in the classroom for the sake of truth. Discussion is less efficient than presentation by the effectiveness of information transmission, but it is valuable for consolidating data, creative understanding of information under the study, and forming value orientations. Among the factors that contribute to deepening learning information during discussion, researchers include the following: each student is reviewing information available from other participants (sharing information); assumption of different, contrasting opinions and suggestions about the subject of discussion; possibility of criticism; motivating participants to seek group agreement in the form of a consensus or decision.

Table 4. Differences of a person-centred approach to providing Educational services

No	Traditional education	Person-centred approach
1.	Providing educational services is a process of personality assimilation of generalized, social experience caused by an external action. Every socially important thing becomes important to personality (Kliberg L. Problems in the Theory of learning. Moscow: Pedagogy, 1984. p. 25.)	Person-centred approach is providing educational services that ensure the development and self-development of the student's personality based on the identification of his individual characteristics as a subject of cognition and academic activity (New values of learning. Moscow: RFFIPI, 1995. p. 55.)
2.	Selected understanding of a person obtaining educational services: "man - clay" - has no initial essence (a blank sheet) and is a basic material for pedagogical activity.	Selected understanding of someone who obtains educational services: "person - family" - has a genetic development program. Education as a development of potential qualities and abilities.
3.	Teacher is a core personality of educational process	Student is at the center of educational process.
4.	Education: Teaching + Learning: The teacher imparts knowledge; facilities and skills to the students, and students learn and recover them.	Education: collaborative activity of a student and a teacher, aimed at the individual self-realization of a student and development of his personal qualities in the process of learning. A person-centred approach more closely reflects the concept of "learning" than the concept of "study".
5.	Teaching is leading activity of the educational process.	Leading activity of educational process is activity of cognition.
6.	Personal difference of children is levelled in educational process, all children meet the only educational "bar" is Standard.	The difference in personal experience of children is maximally revealed in the educational process, and the focus here is on student personality.
7.	Public interests are placed above personal interests.	The highest level of personal dignity is recognized.
8.	Teacher, together with the textbook, is the main source of knowledge. Moreover, teacher is controlling authority of knowledge.	The role of teacher is to organize educational environment, where student independently obtains educational services, using their own potential and appropriate educational technology.

Didactic tasks of the discussion are related to the assignments: 1) concrete content plan; 2) organization of interaction in a group, class.

Primary tasks include recognition of contradictions and difficulties associated with the problem under discussion; updating previously acquired knowledge; creative review of their possible application and addition to a new context, etc.

Secondary tasks include dividing roles in teams; teamwork; consensus in discussing the problem and developing a common approach to it; compliance with special policies and procedures for collaborative research activity etc.

Choosing a topic for discussion is always a problem for teacher. He should use the following basic criteria *promptness* and *convenience* for educational process (relevance to the topic, importance and novelty, teacher's inclination to apply all this into the practice, sufficient student preparation, etc.).

As to the experience of discussions, a significant role is given to creation of the atmosphere of benevolence and respect for each participant in educational process. An important element of managing discussion process is its focusing on topics and participants orientation on the issues being discussed. Summing up the discussion, the following points should be emphasized: resume of the topic information; overview of the facts provided and summary of the discussion in details; reformulation; retelling temporary conclusions; debates analysis. Pedagogical value of a discussion is its analysis and evaluation by each participant.

Therefore, teacher should systematically use innovative educational technologies to train efficient, tolerant, competitive and active member of society in the conditions of secondary educational institution. We have considered only a small part of pedagogical technologies that make it possible to implement teacher's creative approach to educational process.

Conclusions.

Consequently today, scientists and practitioners attention is directed to the development of innovative teaching and educational technologies and their effectiveness, but training of pedagogical staff to use innovative teaching technologies is still insufficient. Low efficiency of teacher's preparation to his pedagogical activity prevents the improvement of education content.

The process of training teachers is related to the improvement of their professional skills and should comprise pedagogical activity that provide:

- 1) preparation for educational process and its specific design;
- 2) accomplishment and implementation of new projects in the educational process;
- 3) evaluation of the results and effectiveness of pedagogical activity.

Thus, teacher's innovative activity is manifested in social arrangement, its connection with social values, roles, norms and a culture. Innovations are essentially different in scale and focus on the person in different social processes. Today, the teacher has the freedom of choice for professional activity. Moreover, he has an open road to creativity. Innovative processes today can be divided into several cycles of training, education and development of secondary school students, namely: establishment, development and transformation. Each of the aspects contains regulatory support for innovative forms; purposeful practical modeling of educational projects; showing the willingness of teachers and leaders to participate in the implementation of the new. Innovative mechanisms of educational development conduct: setting up creative atmosphere, socio-cultural and relevant conditions for various innovations adoption and functioning.

Pedagogical activity of a teacher is reflected in the following aspects of the subject: systematizing mental image on the base of experience; teacher's needs; arrangements; emotions; goals and motives that determine the focus of pedagogical activity.

References

1. Honcharenko, S.U. (2011). Ukrainian Pedagogical Encyclopedic Dictionary. Rivne: Volynski oberehy [in Ukrainian].
2. Burkova, L.V. & Fedorova, N.F. (2001). Grains of Pedagogical Innovation. Kyiv: Vyd. Kyivska pravda [in Ukrainian].
3. Danylenko, L.I. (Ed.) (1999). Glossary of Terms for Innovation Management. Kyiv.
4. Hryhorchuk T.V. (2004). Interactive teaching methods in the modern system of educational services of higher education institution. Collection of scientific works. 32, 59 [in Ukrainian].
5. Bezyuleva G.V. (2005). From tolerant teacher to tolerant student. Vocational Education. 2, 28–29 [in Ukrainian].
6. Orlovska N.M. N.A. Osatiuk, T.P. Tomchyshyna, S.G. Shenhilevych (Eds.) (2012). School of tolerance: the way to the formation of society's tolerance Chernivtsi-Kyiv: Burekk.
7. Podlasy I.P. (1999). Pedagogy. New course: A textbook for students of pedagogical higher education institutions: In 2 books. Moscow: Humane. Edition VLADOS Center [in Russian].
8. Luchaninova, O., Koval, V., Deforz, H., Nakonechna, L. & Golovnia, O. (2019). Formation of communicative competence of future specialists by means of group work. *Espacios*, 40 (41), 11.
9. Petrova, M., Koval, V., Tepavicharova, M., Zerkal, A., Radchenko, A., & Bondarchuk, N. (2020). The interaction between the human resources motivation and the commitment to the organization. *Journal of Security and Sustainability Issues*, 9(3), 897-907. [https://doi.org/10.9770/jssi.2020.9.3\(15\)](https://doi.org/10.9770/jssi.2020.9.3(15))
10. Bodnar, S., Mirkovich, I., Koval, V. (2019). Human capital development in Ukrainian education system by means of language integrated teaching. *Dilemas contemporaneos-educacion politica y valores*, 7 (SI), 14.
11. Nazarova T.S. (1997). Pedagogical technologists: a new stage of evolution? *Pedagogy*.

MODERN APPROACHES TO KNOWLEDGE MANAGEMENT DEVELOPMENT

Collective monograph

Copying of content is not permitted except for personal and internal use, to the extent permitted by national copyright law, or under the terms of a CC BY-NC 4.0 License.

Publisher:
Ljubljana School of Business
Tržaška cesta 42, 1000 Ljubljana
info@vspv.si

Ljubljana 2020

Publication is freely available online at
<https://www.vspv.si/sl/o-soli/publikacije>