

A Method of Experimental Studies of Heat Transfer Processes between Adjacent Facilities

Vadym Nizhnyk^{1*}, Stanislav Shchipets², Olexandr Tarasenko³, Vitalii Kropyvnytskyi¹, Bogdan Medvid²

¹The Ukrainian Civil Protection Research Institute

²Cherkassy Institute of Fire Safety named after Chernobyl Heroes of National University of Civil Protection of Ukraine

³National University of Civil Protection of Ukraine

*Corresponding author E-mail: niznyk@ukr.net

Abstract

A method of experimental studies of heat transfer processes between adjacent facilities during fire was developed. Equipment necessary for the experimental studies was determined. A new specimen type for studies was created in order to perform experimental studies. Configuration of the specimen for the studies allows simulation of a building fragment with filler structures which is affected by heat radiation emitted by fire. Points of placement of the specimens for studies relative to the heat flux source when conducting experimental studies were substantiated. It was revealed that height of the specimen installation shall be determined so that the test specimen is located below the flame tip in order to take into account the most severe impact of heat radiation coming from the fire bed and to exclude any possibility of irradiation from the ground surface. It was proposed that the test specimens are placed at the level of the lower edge of the window opening of the building fragment at the distances of 2 m, 4 m and 6 m from the building fragment. The sequence of conduction of experimental studies of heat transfer processes between adjacent facilities during fire was developed.

Keywords: fire breaks; irradiation of buildings because of fire; heat flux; heat radiation

1. Introduction

One of the principal requirements of [1] for constructions related to fire safety is restriction of fire and smoke spreading within them as well as to any adjacent constructions and territories. One of the ways of the realization of this requirement lies in the arrangement of fire breaks between adjacent facilities [2].

Today substantiation of fire breaks is realized by command method which anticipates use of values specified by appropriate building codes.

Normative documents specify as well a recognized parametric (calculation) method for the fire breaks determination which anticipates analyzing dynamics of possible fire development at each of the adjacent facilities as per the most hazardous scenario followed by calculation of proper fire break.

No methods are available in Ukraine at present which would allow realization of the calculation method for fire breaks determination.

2. Literature Review

Analysis of appropriate literature sources showed that thermal effect of fire is provided by heat transfer on account of radiative heat exchange [3 – 12]. This phenomenon shall be taken into account when substantiating fire breaks between buildings, too [9 – 12]. Classical theory of radiative heat exchange underlies the substantiation of fire breaks between buildings. Essence of the tasks is reduced to the comparison of heat flux density irradiated by the facility being on fire q_{irr} with maximum allowable heat flux density of the materials used at the irradiated facility q_{all} , equation (1) [11].

$$q_{irr} \leq q_{all}, \quad (1)$$

where q_{irr} is density of flux irradiated by the facility on fire; q_{all} is maximum allowable heat flux density for appropriate materials.

3. Purpose, Task and Results

The purpose of this article is the development of a method of experimental studies of heat transfer processes between adjacent facilities when simulating fire. The following tasks were to be solved in order to achieve the set purpose:

- determining types of test equipment necessary for the experimental studies;
- developing configuration of the specimen for studies;
- substantiating points of placement of the specimens for studies relative to the heat radiation source;
- to develop sequence of conducting experimental studies.

Equipment used for the conduction of the full-scale experimental studies includes the following: building fragment (Figure 1), specimen for studies, measuring instruments and equipment for photo and video shooting.

The following measuring instruments were used in the study:

- thermocouples;
- “Thermocount” measuring and calculating system;
- RAP-12M.2 thermal radiation receiver;
- heat flux meter;
- control unit;
- water moisture gauge for wood;
- R10 UZK measuring tape;

- MV-4M aspiration hygrometer;
- M67 aneroid barometer;
- ASO-3 winged anemometer;
- still and video cameras.

Building fragment is a two-storied construction shown in Figure 1 with plan dimensions equal to 4.5 m × 4.5 m × 5.6 m. Area of the first storey is fire chamber and is designed for the simulation of fire load within it, the latter ensuring within the chamber time-temperature curve close to the standard one during 30 minutes. Fire load is created in the form of wooden stack consisting of bars cross section of those measuring 3.8 mm × 8.9 mm. Moisture content of the bars shall not exceed 12 %. Specific fire load ensured by the stack (in terms of wood) shall be not less than 25 kg/m².

The stack is installed at a height of 0.2 m above the floor using concrete blocks. Two pans measuring (1,800 ± 20) mm × (160 ± 5) mm × (60 ± 5) mm installed under the stack are used for its ignition. 3.0 l of diesel fuel is poured into the pans.

Distance between the flooring of the first and the second storey is 2.8 m. The floor of the first storey is 0.3 m thick reinforced concrete slab. Ceilings of the floor and of the roof are 0.2 m thick reinforced concrete slabs. The room of the first floor has a 1.2 m × 2.4 m window opening. Walls of the fragment are made of 0.19m hollow concrete slabs. Wall "A" of the building fragment is designated for the installation of fire load in the form of 100 mm × 100 mm wooden timberwork. Relative humidity of the timberwork shall not exceed 12 %.

39 cm × 39 cm cross section columns are built using hollow concrete blocks. The rooms have door openings. The latter of the first storey was closed before starting the study. The door opening of the second storey shall be open in the course of the study.

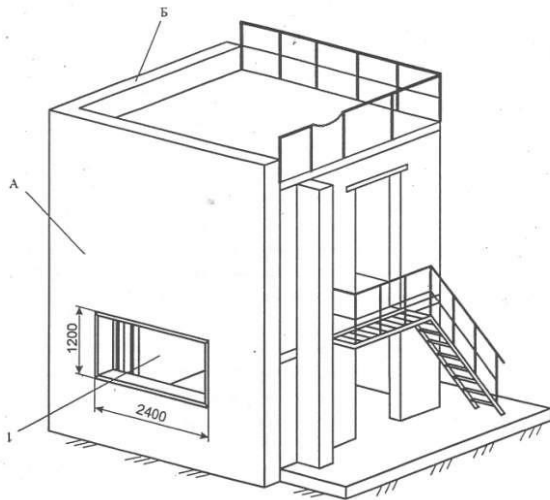

Fig. 1: Building fragment: A – the wall designed for façade installation, 1 – window opening.

Fire load in the form of wooden timberwork measuring 100 mm × 100 mm is mounted on the wall "A" of the building fragment. Fire load within the fire chamber is created in the form of wood bars compiled as stack. Specific fire load ensured by the stack (in terms of wood) is not less than 25 kg/m²; this reflects creation of time-temperature curve within the fire chamber being the closest to the standard one during 30 minutes.

The following items are used as measuring instruments: heat flux meter, RAP-12M.2 heat radiation receiver, thermocouples, "Thermocount" measuring and calculating system, control unit, and VPK-12 wood moisture content meter.

7 solid pine boards measuring 50 mm × 250 mm × 250 mm were selected for the fabrication of the specimen for studies. Connection of the boards with each other was done as per layout shown in Figure 2.

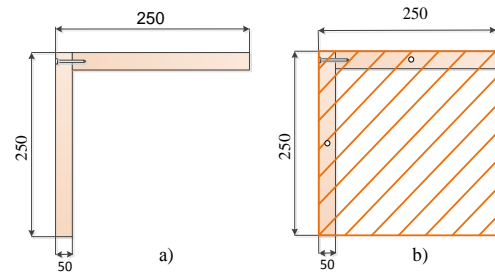

Fig. 2: Layout of the board joint (view from above): a) joint of the boards of adjacent sides; b) edge joint of the boards (from one side only).

Upon joining of the boards, the specimen for the studies takes configuration shown in Figure 3.

Proposed configuration of the specimen for the studies allows simulation of a building fragment with surrounding constructions effected by heat radiation at fire. Such the specimen configuration due to its appropriate orientation relative to flame is to allow taking into consideration the fact that during experimental studies the most unfavourable conditions are those anticipating the most intensive heating of the specimen surface.

Configuration of the specimen for the studies proposed is a new one as opposed to existing prototypes configurations of those were described in papers [9-12] which were in essence square-shaped cross-section materials installed perpendicularly relative to heat radiation source; this allows simulation of space planning solutions of buildings and constructions being affected by heat radiation emitted by fire and taking into account the most severe conditions of the experimental studies due to positioning of the specimen for the studies relative to heat radiation source at such an angle that both its sides are effected by heat radiation simultaneously.

Edges and internal surfaces of the boards of the specimen for the studies are sheathed with 20 mm thick MKRF-100 silicon based heat insulation material in order to prevent heat loss due to heat transfer through the boards of which the specimen was fabricated.

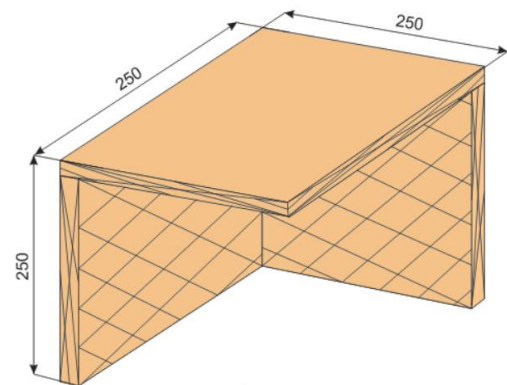

Fig. 3: Final view of the specimen for studies assembled (indicate places of covering of the specimen for studies with insulating layer).

An aperture is to be drilled on the specimen surface for the purpose of temperature measurement by installing a thermocouple according to the layout shown in Figure 4. Its drilling should be done in such a way that thickness of the undrilled portion to reach the specimen surface lies within the bounds of 1 to 2 mm; this will ensure obtaining the most reliable data when measuring surface temperature of the specimen for studies.

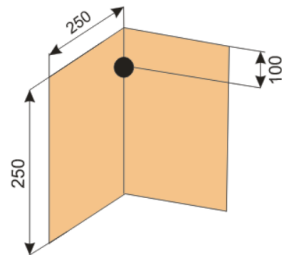

Fig. 4: Thermocouples placement layout.

In order to substantiate points of placement of the specimens for studies relative to heat radiation source we conducted experimental studies for the revelation of temperature distribution outside the window opening (at various distances from the latter and at various height) in the building fragment caused by burning of fire load in the form of stack positioned within the fire chamber. Layout of the thermocouples placement relative to the window opening of the building fragment is shown in Figures 5 to 7.

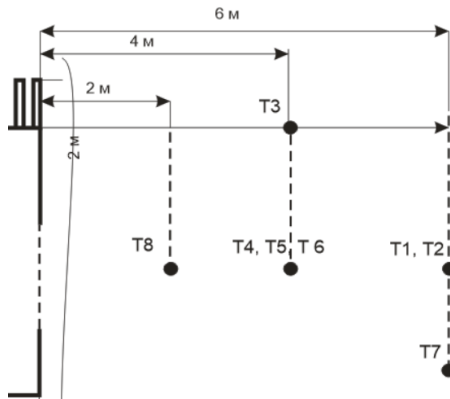

Fig. 5: Layout of the thermocouples placement relative to the window opening of the building fragment (top view): layout of thermocouples (T1 – T8).

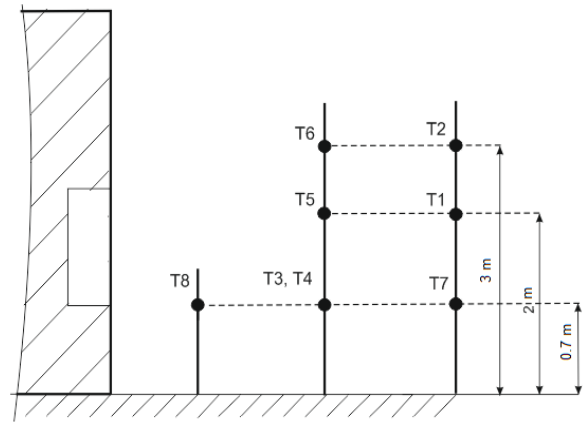

Fig. 6: Layout of the thermocouples placement relative to the window opening of the building fragment (side view): layout of thermocouples (T1 – T8).

Temperatures vs. heat flux duration at various points relative to window opening of the building fragment are shown on Figure 8. Thus, one can conclude that the most intensive heat flux affects the specimens positioned along the central axis of the window opening of the building fragment and located at the height which corresponds to the lower edge of the window opening.

Therefore when conducting experimental studies of the heat transfer processes between adjacent facilities, height of installation of the test specimens shall be determined based upon calculation in order that the test specimen is positioned below the flame tip to take into account the most severe effect of heat radiation from the fire bed and exclude any possibility of irradiation from the earth surface.

For this reason we proposed to place test specimens at the level of the lower edge of the window opening of the building fragment at the distances of 2 m, 4 m and 6 m from the building fragment.

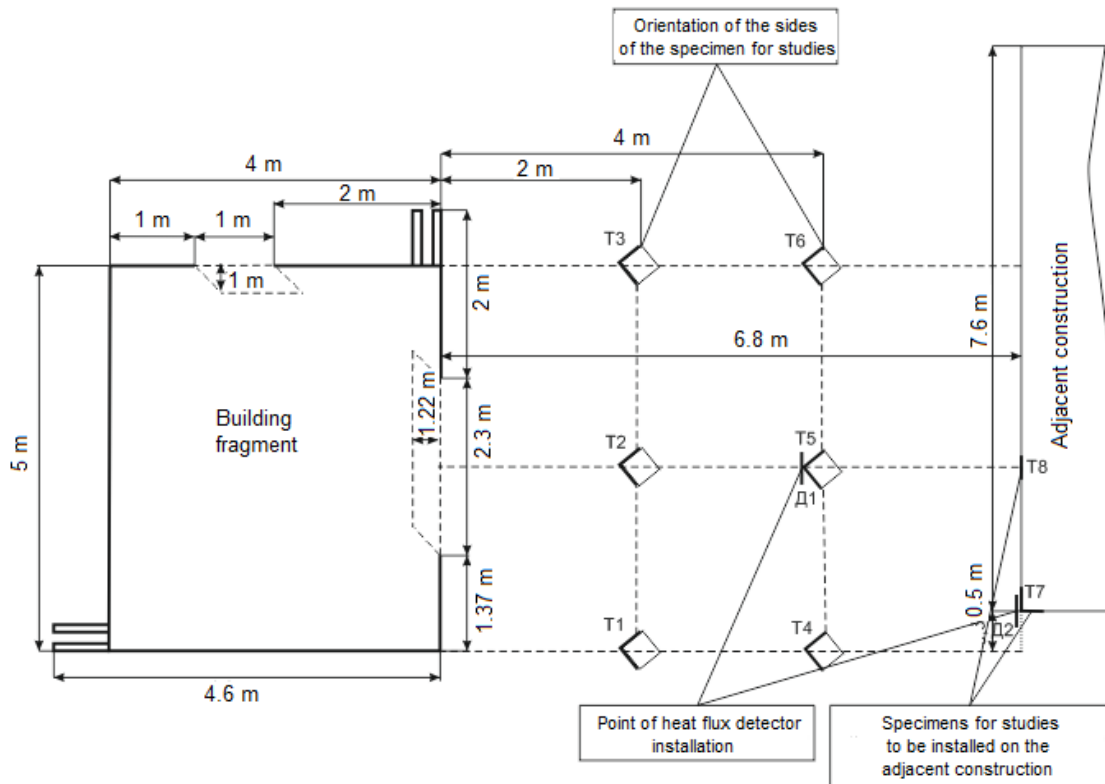

Fig. 7: Layout of the specimens for studies and measuring instruments: T1 – T8 points of the thermocouples installation.

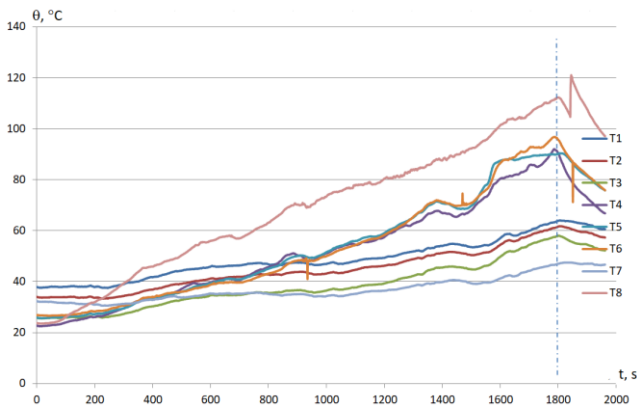

Fig. 8: Temperatures vs. heat flux duration: θ - temperature, t - time, (T1 - T5) - thermocouple numbers.

For this reason we proposed to place test specimens at the distances of 2 m, 4 m and 6 m from the building fragment.

Proper experimental studies should be conducted in two stages: the building is supplied with fire load in the form of stack positioned within the fire chamber (stage 1); the building is supplied with fire load in the form of stack positioned within the fire chamber as well as the one mounted on its wall "A" (stage 2). Each stage of full-scale fire tests should be conducted not less than thrice.

We conduct experimental studies in the following sequence:

1. Preparation:

1.1 Fabrication of the specimens for studies as well as creation of fire load and its positioning in place

1.2 Positioning of the specimens and measuring instruments as per layout shown on Figure 4;

1.3 Connection of the measuring instruments with appropriate recorders and check-up of their working order. The thermocouples are connected with the "Thermocount" information and measuring system, and heat radiation receivers as well as heat flux meter are checked for their proper operation.

1.4 Preparation of the equipment necessary for photo and video shooting.

2. Sequence:

2.1 Measuring and recording of the environmental conditions (air temperature, wind velocity, humidity and atmospheric pressure) are performed:

- air temperature and humidity are measured with MV-4M aspiration hygrometer;

- atmospheric pressure is measured with M67 aneroid barometer;

- wind velocity is measured with ASO-3 winged anemometer

2.2 Measurement and recording of the initial values of temperatures and heat radiation are conducted by indications of the thermocouples connected to the "Thermocount" information and measuring system as well as heat radiation receivers connected to the heat flux meter.

2.3 Pans used for the stock ignition are filled with diesel fuel not more than 3 minutes before the start of the study and door opening of the first floor of the building fragment is closed.

2.4 "Thermocount" information and measuring system and heat flux meter are switched to record mode and video shooting is triggered; the pans are ignited with a remote electric igniter.

2.5 Temperature and heat flux recording are done at intervals not exceeding 1 min. Video shooting is performed at the moment of the most intensive burning of the fire load. Photo and video shooting are done in order to determine flame geometrical parameters; some racks with pre-marked distance scale are positioned near the building fragment for this purpose.

The studies last until full burn-out of the fire load.

3. Estimation:

3.1 As results of the studies, we obtained data as to temperatures by thermocouples indications, heat flux by indications of heat

radiation receivers and flame geometrical parameters due to photo and video shooting of the study process.

3.2 The data are recorded in the course of the study and are put down to the diary of experimental studies.

3.3 Error of the study results is determined by the data obtained using formula (2) as follows:

$$\Delta A = \pm k \sqrt{(\Delta A_1)^2 + (\Delta A_2)^2}, \quad (2)$$

where ΔA stands for absolute error of the figures under study;

ΔA_1 stands for error of detectors (thermocouples, heat flux meter, and instrumental one);

ΔA_2 stands for error of measuring devices ("Thermocount" information and measuring system, heat flux meter, and error of reading of the results when measuring dimensions);

k is a factor which depends on probability ($k = 1.1$ at $P = 0.95$) [13].

When performing experimental studies we derive average temperature and heat flux values as well as flame geometrical parameters. Temperatures, heat flux and flame geometrical parameters versus time are plotted.

4. Conclusions

A method of experimental studies of heat transfer processes between adjacent facilities is proposed in this paper, and at that:

- A new specimen type for studies was developed configuration of which allows simulating building fragment with surrounding constructions effected by heat radiation during fire and gives an opportunity to take into account when conducting experimental studies the least favourable conditions under which heating of the specimen surface will be the most intensive;

- Points of placement of the specimens for studies relative to heat flux source were substantiated and it was revealed that when conducting experimental studies of heat transfer processes between adjacent facilities height of the specimen installation shall be determined based on the fact that test specimen shall be positioned below the flame tip in order to take into account the most severe heat irradiation from fire bed and exclude possible irradiation from the ground surface;

- Sequence of conduction of experimental studies of heat transfer processes between adjacent facilities during fire was developed.

References

- [1] *Pro zatverdzhennia Tekhnichnogo rehlamentu budivelnikh vy-robiv, budivel i sporud*, Postanova Kabinetu Ministriv Ukrainy [chynna 2006.12.20], K: Kabinet Ministriv Ukrainy, (2006), stattia 11.
- [2] *Pozhezhna bezpeka ob'ektiv budivnystva. Zahalni vymohy*, DBN V.1.1-7:2016, [Chynnyi 2017.06.01], K.: Minrehion Ukrainy, (2017), p.6. (Derzhavni budivelni normy).
- [3] Pozdieiev S., Nuianzin O., Sidnei S., Shchিপets S., "Computational study of bearing walls fire resistance tests efficiency using different combustion furnaces configurations", *MATEC Web of Conferences*, Vol.116, No.02027, (2017), pp.1-5, available online: <https://doi.org/10.1051/mateconf/201711602027>.
- [4] Nekora O., Slovynsky V., Pozdieiev S., "The research of bearing capacity of reinforced concrete beam with use combined experimental-computational method", *MATEC Web of Conferences*, Vol.116, No.02024, (2017), pp.1-5, available online: <https://doi.org/10.1051/mateconf/201711602024>.
- [5] Mygalenko K., Nuyanzin V., Zemlianskiy A., Dominik A., Pozdieiev S., "Development of the technique for restricting the propagation of fire in natural peat ecosystems", *Eastern-European Journal of Enterprise Technologies*, Vol.1, No.10 (91), (2018), pp.31-37, available online: <https://doi.org/10.15587/1729-4061.2018.121727>.
- [6] Danchenko Y., Andronov V., Teslenko M., Permiakov V., Rybka E., Meleshchenko R., Kosse A., "Study of the free surface energy

- of epoxy composites using an automated measurement system”, *Eastern-European Journal of Enterprise Technologies*, Vol.1, No.12 (91), pp.9-17, available online: <https://doi.org/10.15587/1729-4061.2018.120998>.
- [7] Pospelov B., Andronov V., Rybka E., Popov V., Romin A., ”Experimental study of the fluctuations of gas medium parameters as early signs of fire”, *Eastern-European Journal of Enterprise Technologies*, Vol.1, No.10 (91), (2018), pp.50-55, available online: <https://doi.org/10.15587/1729-4061.2018.122419>.
- [8] Pospelov B., Andronov V., Rybka E., Popov V., Semkiv O., ”Development of the method of frequency-temporal representation of fluctuations of gaseous medium parameters at fire”, *Eastern-European Journal of Enterprise Technologies*, Vol.2, No.10 (92), (2018), pp.44-49, available online: <http://journals.urau.ua/eejet/article/view/125926/124844>.
- [9] Hrushevskiy B.V., Yakovlev A.I., Krivosheyev I.A., *Pozharnaya profilaktika v stroitelstve*, Moscow: VYPTSh, (1985), pp.451.
- [10] Roitman M.Ya., Komissarov Ye.P., Pchelintsev V.A., *Termodinamika i teploperedacha v pozharnom dele*, Moscow: VYPTSh, (1977), pp.415.
- [11] Romanenko P.N., Koshmarov Yu.A., Bashkirtsev M.P., *Pozharnaya profilaktika v stroitelstve*, Moscow: Stroyizdat, (1978), pp.363.
- [12] Morgan J. Hurley at al., *SFPE Handbook of fire protection engineering*, Greenbelt, MD, USA, Society of Fire Protection Engineers, (2016), p.3512.
- [13] GOST 12.1.044 Pozharovzryvobezopasnost veschestv i materialov.